



B.lux

Decorative
Lighting

Architectural
Lighting

Outdoor
Lighting

grupoblux.us

Proudly Distributed by

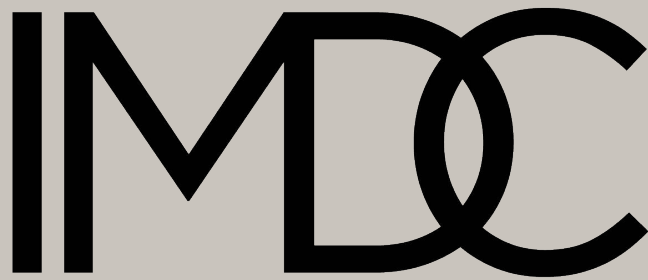

IM DESIGN CONCEPTS

B.lux

Manufacturers	06
Designers	14
Decorative lighting	26
Suspension lamps	29
Floor lamps	117
Table lamps	137
Ceiling lamps	159
Wall lamps	193
Lighting systems	219
Architectural lighting	241
Outdoor lighting	277
Iconography	300

B.lux

The essence of our land and its traditions

We work from an enclave located in the heart of nature,
where we combine innovation and tradition with an
offer that fuses technology with the best artwork.
We are deeply rooted in our environment. We are
heirs to the traditional values of our land and to the
best of its industrial character, such as commitment
and satisfaction in the face of a job well done.





Commitment to what is natural

Our environment has given us everything and, to preserve this tremendous asset, we comply with the highest standards of production control and waste management. Ninety per cent of the raw materials we use are of Spanish origin and we use wood from controlled forests that meet the sustainability criteria established by the PEFC. This is just a small example of the many measures that we have taken to raise B.lux to the level of an industry with a present and future committed to nature.

Control, trust and effort

Our products are distributed in 65 countries on five continents.

This outstanding international presence is possible thanks to the rigorous control of the manufacturing and distribution processes to which we subject our luminaires, allowing them to meet and exceed the most demanding quality standards.

We are committed to long-lasting relationships based on trust between manufacturer and customer. Our success is based on a slow growth, sustained over time, which advances with secure steps. There are no secrets – this is the natural result of our team's dedication and talent focused on offering the best service.



#berespectful

As part of our Corporate Social Responsibility (CSR) policy, we have developed a comprehensive plan that establishes and fosters our key targets for sustainable development.

#berespectful embodies our commitment to the environment, innovation, the social and economic scene and product quality.





1. Our products are made with recycled material and are recyclable.
2. We participate in the circular economy producing products that have a long life.
3. 100% of our electrical consumption comes from renewable sources.
4. Day after day, we fight to reduce our carbon footprint. This is why we implement policies to keep waste to a minimum, recycle and use recycled materials.
5. We promote innovation and incorporate technological advances in order to grow and help our community grow as well.
6. We support the local industry. Our suppliers are European and many of them live in our region.
7. Our company ethics are to work for the right to progress, workplace security, and for the equality of opportunities for men and women.
8. We carry our activities and alliances with like-minded organizations.
9. We work towards a more human, eco-friendly and sustainable future.

Designers

Collaboration with top external designers has always been a cornerstone of our trajectory and growth. This strategy, which is widespread today, was not so common in the early 80s, when we embarked on our first collaborative experience with Guillermo Capdevilla, who designed the successful B.lux System. Since then, we have focused on channelling the creative wealth of established professionals and talented up-and-coming designers with a view to offering a coherent, innovative and up-to-the-minute product range.



AIA Salazar-Navarro



Carlos Serra



David Abad



e27, Tim Brauns



Gemma Bernal



Jan Van Lierde



Jon Santacoloma



Jorge Pensi



Mario Ruiz



Miguel Ángel Ciganda

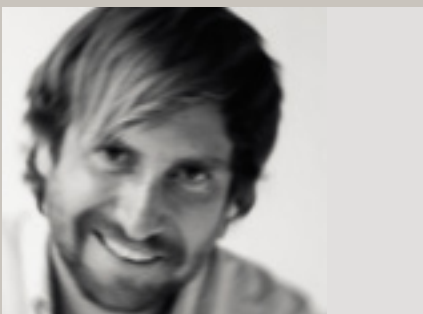

Miguel Herranz



Stone Designs



Werner Aisslinger

Decorative lighting

Suspension lamps

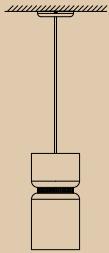

Aspen
p. 30

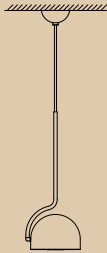

Bowee
p. 34

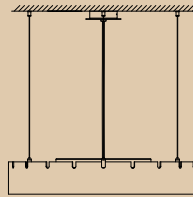

Castle
p. 40

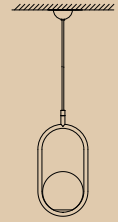

C_Ball
p. 44



Centra / Minicentra
p. 48

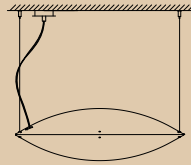

Clon
p. 50



Cone Light
p. 52

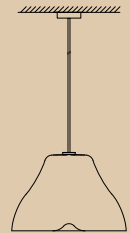

Ginkgo
p. 54

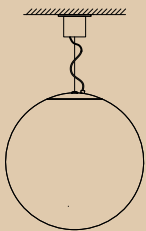

Globe
p. 56

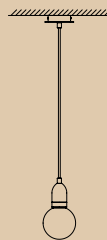

Ilde
p. 58

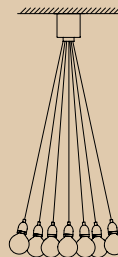

Ilde Max
p. 60

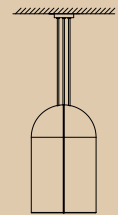

Ireland
p. 64



Keshi
p. 66

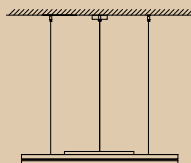

Lite Hole
p. 70

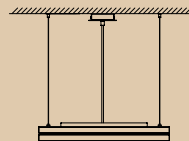

Lite Square
p. 74

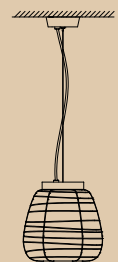

Misko
p. 76

Suspension lamps

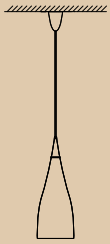

Nite
p. 80

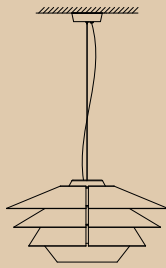

Overlay
p. 82



Phi
p. 86

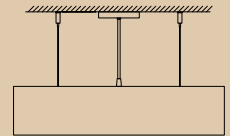

Quadrat
p. 88

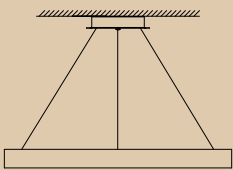

R2
p. 90

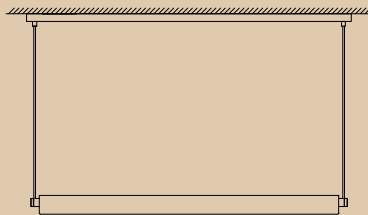

Roof
p. 94

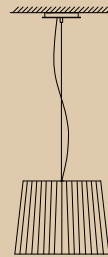

Royal
p. 96

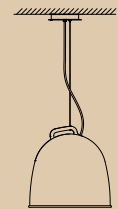

Scout
p. 98

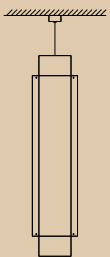

Skin
p. 102

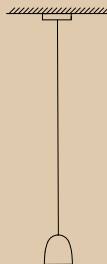

Speers
p. 106

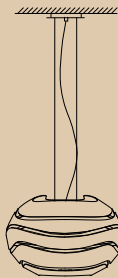

Tree Series
p. 114



Aspen
p. 118

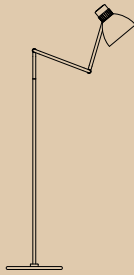

Blux System
p. 120

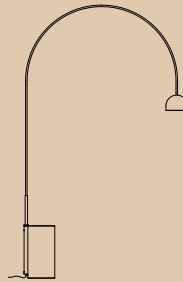

Bowee
p. 122



C_Ball
p. 124

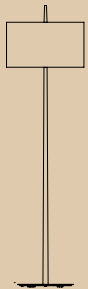

Lola
p. 126



Misko
p. 128



Overlay
p. 130



Royal
p. 132



Speers
p. 134

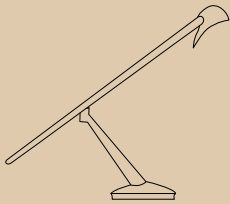

Bluebird
p. 138

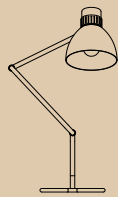

Blux System
p. 140

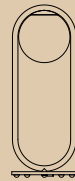

C_Ball
p. 142

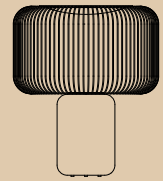

Keshi
p. 144

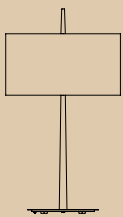

Lola
p. 146

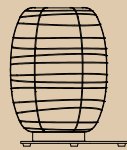

Misko
p. 148

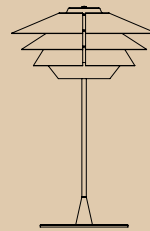

Overlay
p. 150

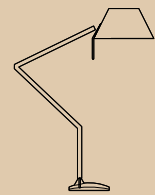

Petite
p. 152



Regina
p. 154

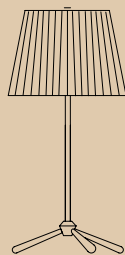

Royal
p. 156

Decorative lighting

Ceiling lamps

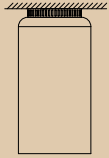

Aspen
p. 160

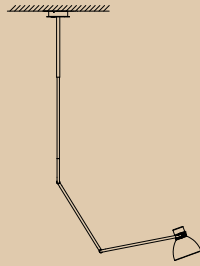

Blux System
p. 164

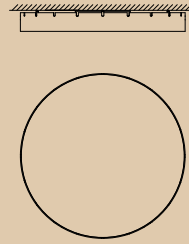

Castle
p. 166

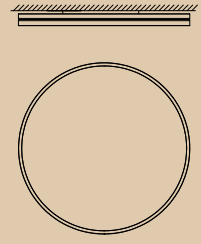

Lite Hole
p. 168

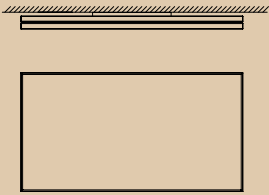

Lite Square
p. 172

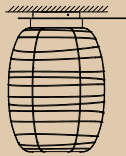

Misko
p. 174



Q. Bo
p. 176



Quadrat
p. 178

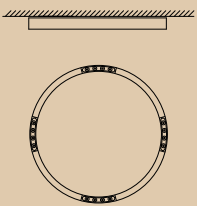

R2
p. 180

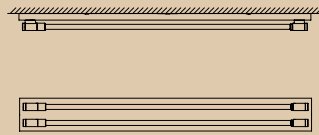

Roof
p. 182

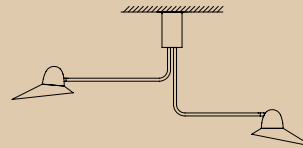

Speers Arm
p. 184

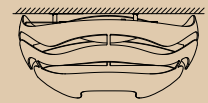

Tree Series
p. 186

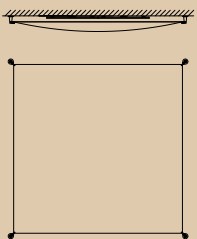

Veroca
p. 188

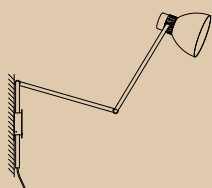

Blux System
p. 194

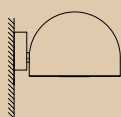

Bowee
p. 198



C_Ball
p. 200



Cone Light
p. 202



Dolce
p. 204



Misko
p. 206

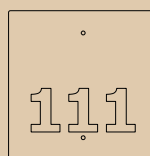

Nora
p. 208

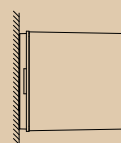

Q. Bo
p. 210

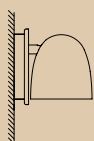

Speers
p. 212

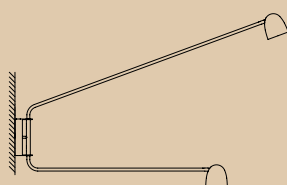

Speers Arm
p. 214

Decorative lighting

System lamps

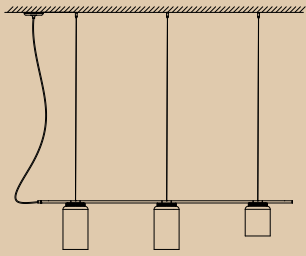

Aspen
p. 220

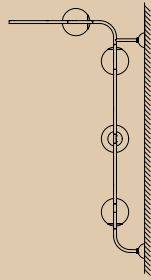

C_Ball System
p. 224

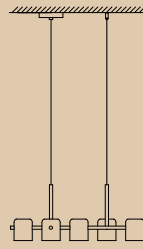

Kup
p. 230



Kupetz
p. 234

Architectural lighting

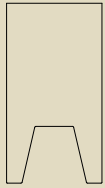

Anvil System
p. 242

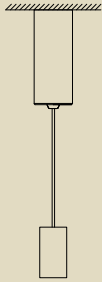

Anvil Spot
p. 258

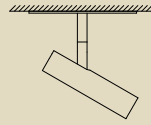

Anvil Slim Spot
p. 260



Anvil Sphere
p. 262

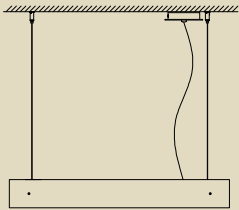

Marc
p. 264

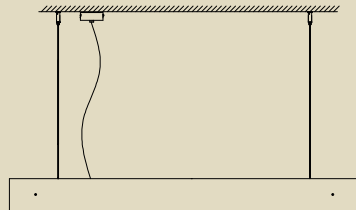

Marc Dos
p. 272

Outdoor lighting

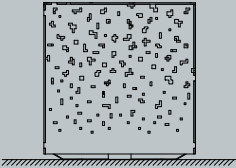

AMS
p. 278

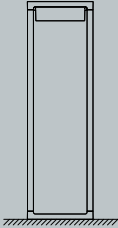

Frame
p. 280



Inn Side
p. 284



Kanpazar
p. 286



Speers Outdoor
p. 290



Speers Outdoor W1 / Bollard
p. 294

B.lux

Decorative lighting



Suspension
lamps



B.lux

Aspen

by
Werner Aisslinger

**Decorative
lighting**

Suspension
lamps



Double-shade suspension lamp, available in three sizes (S17A, S17B and S40). Available with aluminum shade in different matte finishes: grey, snow, lemon, mango, clear turquoise, aqua, merlot, river, sea, rose, limestone, black and brass. All shades can be combined. Direct and diffused light.



Aspen

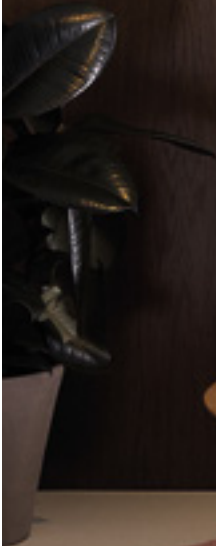



ASPEN S17A

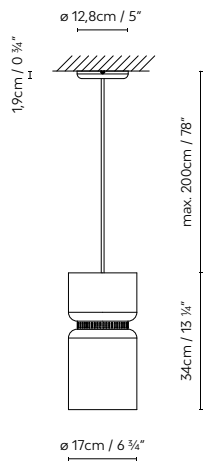

ASPEN S17B

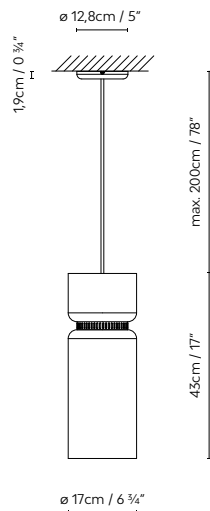

ASPEN S40

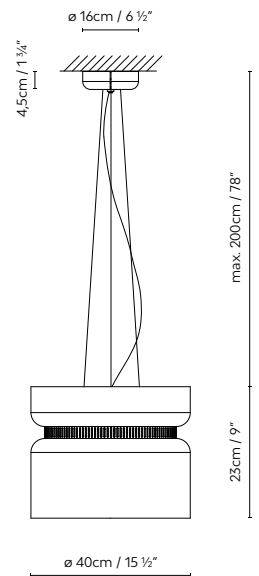

- SHADE:**
- Grey (matte)
 - Mango (matte)
 - Merlot (matte)
 - Rose (matte)
 - Brass (matte)
 - Snow (matte)
 - Clear turquoise (matte)
 - River (matte)
 - Limestone (matte)
 - Lemon (matte)
 - Aqua (matte)
 - Sea (matte)
 - Black (matte)
- RING:**
- Black (matte)

727320U	ASPEN S17A (E26)	LED 15W (E26) / Fluo. CFL max. 30W (E26) / Inc. max. 70W (E26)
727321U	ASPEN S17B (E26)	
727353U	ASPEN S40 (E12)	LED 2 x 6W (E12) / Fluo. CFL 2 x max. 8W (E12) / Inc. 2 x max. 60W (E12)

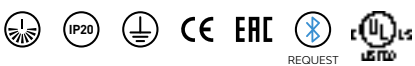

B.lux

Bowee

by
Werner Aisslinger

**Decorative
lighting**

Suspension
lamps

LED suspension lamp made with half-sphere shades, available as vertical (S) or horizontal (SH). Bowee S is available with either one shade (S1) or two shades (S2). Bowee SH comes with four shades (SH4) or six shades (SH6). All light sources can be positioned on the horizontal axis and give diffused light. Available in metallic English bronze, matte turquoise and matte beige.



Bowee





BOWEE S1

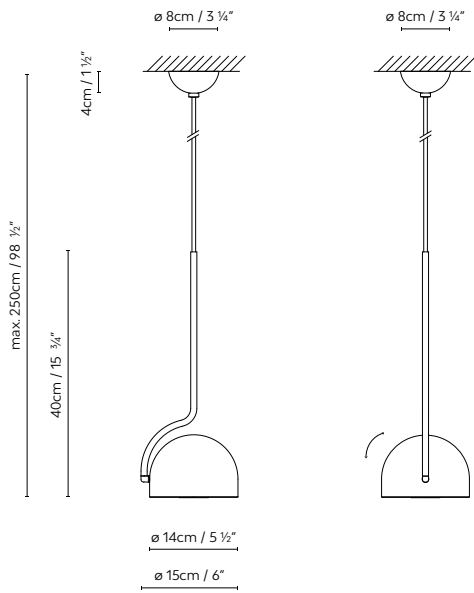

BOWEE S2

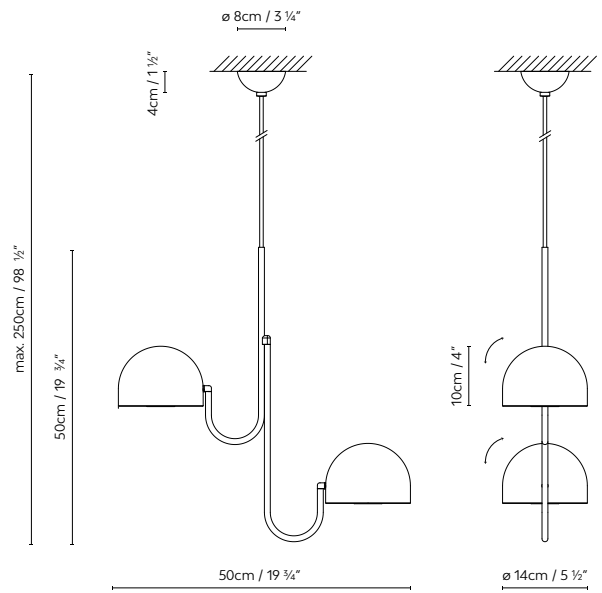

● Beige (matte)
 ● Clear turquoise (matte)
 ● Metallic English bronze

758300U **BOWEE S1 BEIGE**
 758301U **BOWEE S1 CLEAR TURQUOISE**
 758302U **BOWEE S1 METALLIC ENGLISH BRONZE**

LED 6,4W 760lm 350mA 3000K CRI≥90

758320U **BOWEE S2 BEIGE**
 758321U **BOWEE S2 CLEAR TURQUOISE**
 758322U **BOWEE S2 METALLIC ENGLISH BRONZE**

LED 2 x 6,4W 1520lm 350mA 3000K CRI≥90



Bowee



BOWEE SH4

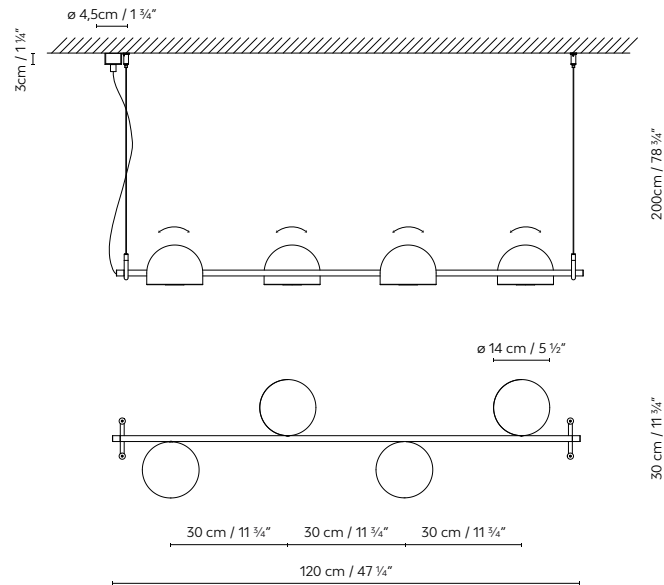

BOWEE SH6

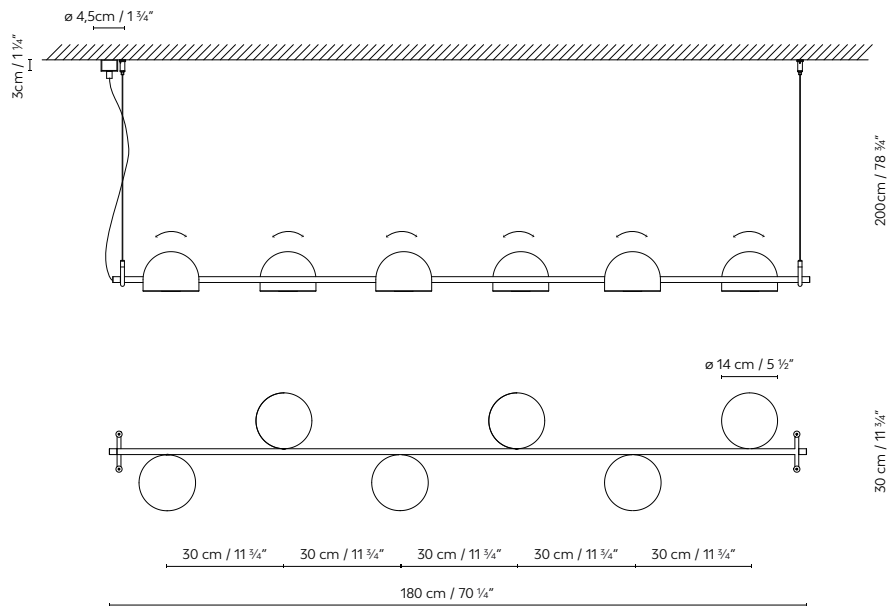

- Beige (matte)
- Clear turquoise (matte)
- Metallic English bronze

758350U	BOWEE SH4 BEIGE	
758351U	BOWEE SH4 CLEAR TURQUOISE	LED 4 x 6,4W 3040lm 350mA 3000K CRI≥90
758352U	BOWEE SH4 METALLIC ENGLISH BRONZE	

758360U	BOWEE SH6 BEIGE	
758361U	BOWEE SH6 CLEAR TURQUOISE	LED 6 x 6,4W 4560lm 350mA 3000K CRI≥90
758362U	BOWEE SH6 METALLIC ENGLISH BRONZE	

B.lux

Castle

by
Stone Designs

**Decorative
lighting**

Suspension
lamps

Round aluminum LED suspension lamp with a highly uniform opal white PMMA diffuser. It allows multiple configurations with a single connection. Finishes: textured matte white, textured matte black and natural oak. Direct light with a soft indirect light effect. Available in three sizes. Dimmer.



Castle





CASTLE S60

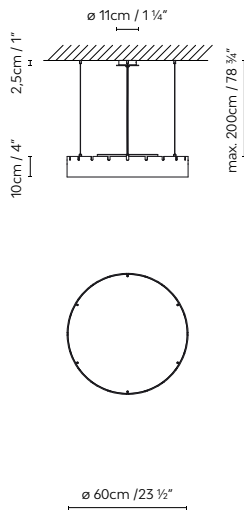

CASTLE S90

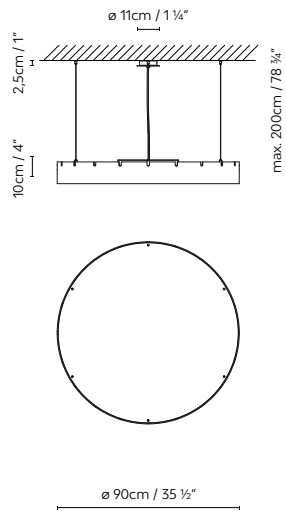

CASTLE S120

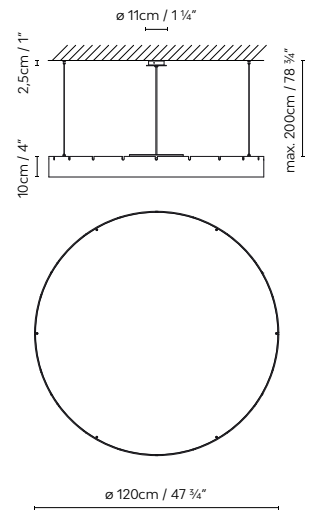

○ White (matte) ● Black (matte) ● Natural Oak

737311U
737312U
737313U

CASTLE S60 WHITE
CASTLE S60 BLACK
CASTLE S60 OAK

LED 17,4W 3416lm 150mA 3000K CRI≥90 110-277V DIM 1-10V

737331U
737332U
737333U

CASTLE S90 WHITE
CASTLE S90 BLACK
CASTLE S90 OAK

LED 41W 7960lm 350mA 3000K CRI≥90 110-277V DIM 1-10V

737351U
737352U
737353U

CASTLE S120 WHITE
CASTLE S120 BLACK
CASTLE S120 OAK

LED 19,5W 3664lm 225mA + LED 41W 7960lm 350mA 3000K CRI≥90 110-277V DIM 1-10V



B.lux

C_Ball

by
Stone Designs

**Decorative
lighting**

Suspension
lamps

Suspension lamp consisting of one (S1) or two (S2) opal glass spheres. Its metal components are available in two finishes: satin brass or matte black.



C_Ball





C_BALL S1

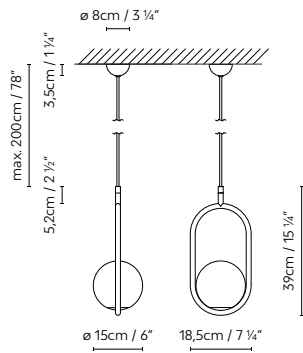

C_BALL S2

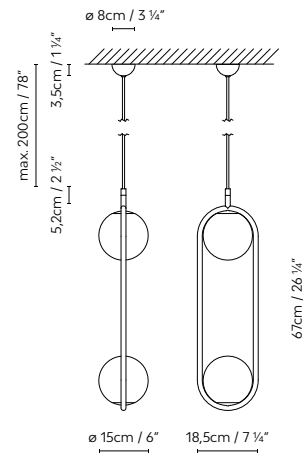

Brass (satin)



Black (matte)

748310U
748315U

C_BALL S1 BRASS
C_BALL S1 BLACK

LED 6W (E12) / Flu. CFL max. 12W (E12) / Inc. max. 40W (E12)

748320U
748325U

C_BALL S2 BRASS
C_BALL S2 BLACK

LED 2 x 6W (E12) / Flu. CFL max. 2 x 12W (E12) / Inc. max. 2 x 40W (E12)



REQUEST



C_BALL F p. 124



C_BALL T p. 142



C_BALL W p. 200



C_BALL SYSTEM p. 224

B.lux

Centra / Minicentra

by
David Abad

Decorative
lighting

Suspension
lamps

Suspension lamp with a metallic structure and blown glass shade. Transparent shade, matte black structure and black textile cable. Available in two sizes (Centra and Minicentra) and with one shade (S1) or two shades (S2).



CENTRA S1

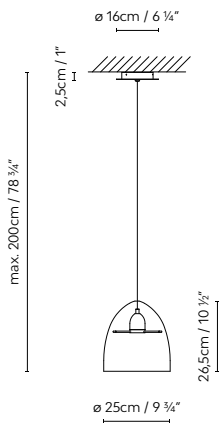

CENTRA S2

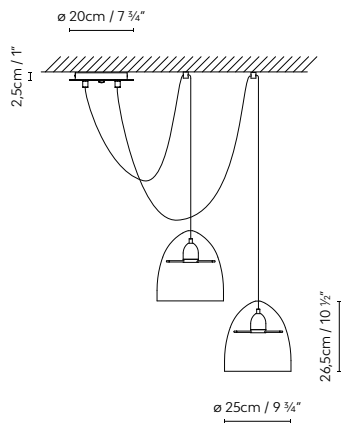

MINICENTRA S1

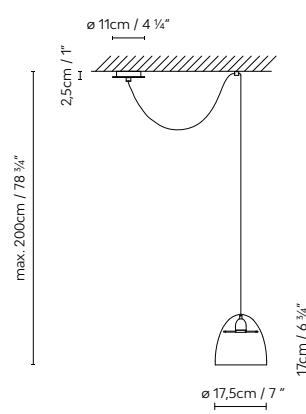

MINICENTRA S2

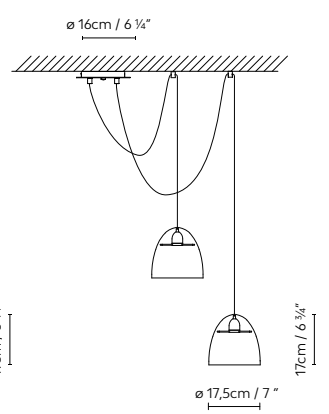

● ● Transparent-Black

711320U
711330U

CENTRA S1 TRANSPARENT-BLACK
CENTRA S2 TRANSPARENT-BLACK

LED max. 11W (E26) / Inc. vintage 60W (E26)
LED 2 x max. 11W (E26) / Inc. vintage 2 x 60W (E26)

711340U
711361U

MINICENTRA S1 TRANSPARENT-BLACK
MINICENTRA S2 TRANSPARENT-BLACK

LED max. 11W (E12) / Inc. vintage 60W (E12)
LED 2 x max. 11W (E12) / Inc. vintage 2 x 60W (E12)



B.lux

Clon

by
Miguel Ángel Ciganda

**Decorative
lighting**

Suspension
lamps

Individual suspension lamps with an opal white PMMA diffuser. Direct and indirect light. It allows for multiple configurations.





CLON S LINK

○ Opal white

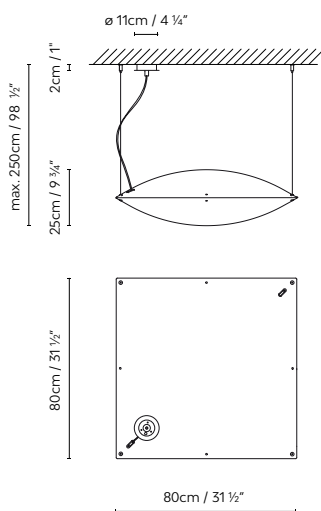

738310U

CLON S LINK

LED 4 x max. 14W (E26) / Fluo. CFL 4 x max. 23W (E26) / Inc. 4 x max. 60W (E26)



REQUEST

B.lux

Cone Light

by
Werner Aisslinger

**Decorative
lighting**

Suspension
lamps

Vitrified translucent porcelain suspension lamp. Single or double versions. Available in texturized matte white with brass fittings. A soft glow around it, and direct light below.





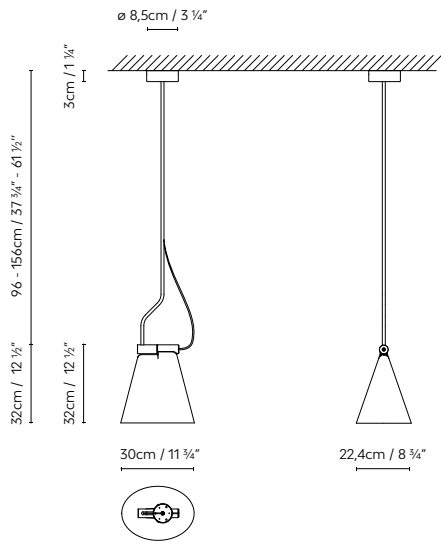

CONE LIGHT S1

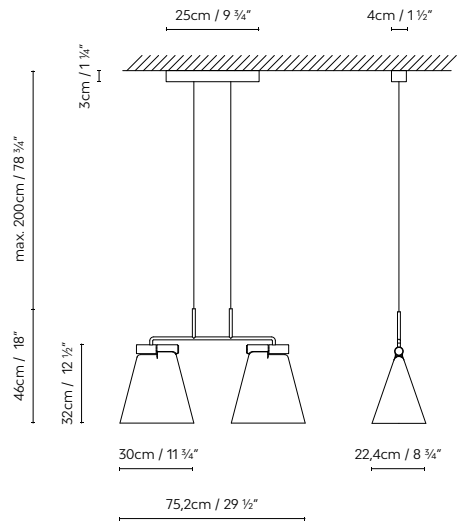

CONE LIGHT S2





 White (matte) / Brass

739313U **CONE LIGHT S1 BRASS** LED 15W (E26) / Fluo. CFL max. 30W (E26) / Inc. max. 100W (E26)

739314U **CONE LIGHT S2 BRASS** LED 2 x 15W (E26) / Fluo. CFL 2 x max. 30W (E26) / Inc. 2 x max. 100W (E26)



B.lux

Ginkgo

by
e27, Tim Brauns

Decorative
lighting

Suspension
lamps

Suspension lamp featuring organic forms, available in two sizes (S40 and S50). Aluminum shade, available in matte brown, matte pink and matte blue, all with a pearl white interior. Also available with the shade in different RAL colors. Textile black cable. Direct light.





GINKGO S40

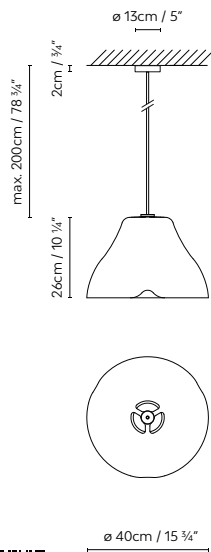

GINKGO S50

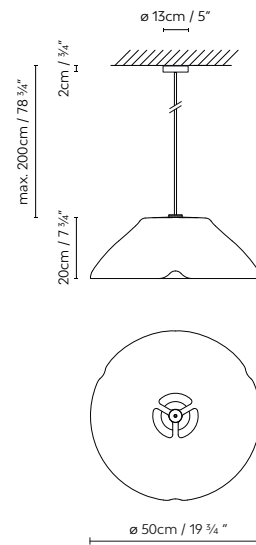

- Brown (matte)
- Pink (matte)
- Blue (matte)

- | | | | |
|--|--|--|--|
| RAL 7037 (matte) | RAL 1034 (matte) | RAL 4004 (matte) | RAL 3015 (matte) |
| RAL 9003 (matte) | RAL 6034 (matte) | RAL 5017 (matte) | RAL 7035 (matte) |
| RAL 1012 (matte) | RAL 5024 (matte) | RAL 5012 (matte) | RAL 7021 (matte) |

740316U **GINKGO S40** LED 15W (E26) / Fluo. CFL max. 23W (E26) / Inc. max. 60W (E26)

740326U **GINKGO S50** LED 15W (E26) / Fluo. CFL max. 23W (E26) / Inc. max. 60W (E26)

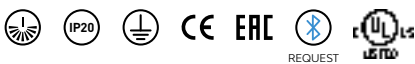

B.lux

Globe

by
Jan Van Lierde

**Decorative
lighting**

Suspension
lamps

Suspension lamp produced in two covers murano
opal white glass. Finishes in matte white.





GLOBE

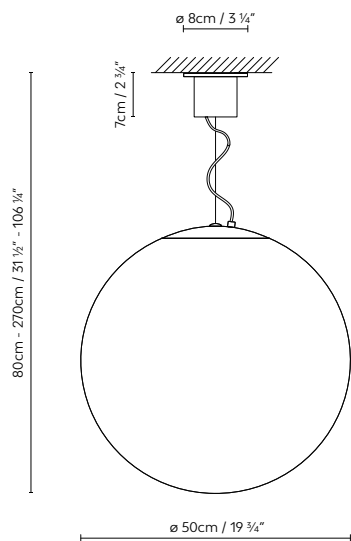

○ Opal White

639300U

GLOBE

LED 13W (E26) / Flu. CFL 23W (E26)
/ Inc. max. 100W (E26)



REQUEST

UL LISTED

B.lux

Ilde

by
David Abad

**Decorative
lighting**

Suspension
lamps

Designed
in 1999

A family of unitary suspension lamps, available in three versions. The Ilde SI features a metallic body and is available in two finishes: matte chrome with a red textile cable; or texturised bronze with a black textile cable. The Ilde Wood S is made of oak, with a brown textile cable.



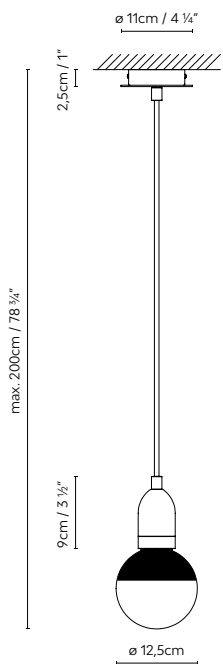

ILDE S1

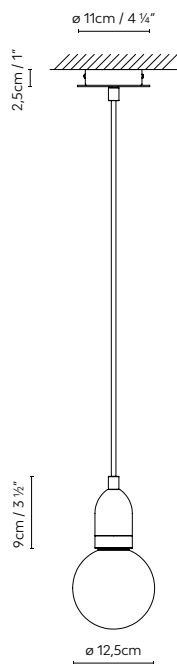

ILDE WOOD S1



ILDE S1:  Chrome (matte)  Bronze (texturised)

ILDE WOOD S1:  Natural Oak

700351U	ILDE S1 CHROME	LED G125 reflector 6W (E26) / Inc. G125 Reflector max. 70W (E26)
700354U	ILDE S1 BRONZE	LED filament G125 6W (E26) / Inc. G125 max. 70W (E26)
700355U	ILDE WOOD S1	LED filament G125 6W (E26) / Inc. G125 18W (E26) / Inc. Vintage max. 40W (E26)



REQUEST

LESTO

B.lux

Ildē Max

by
David Abad

**Decorative
lighting**

Suspension
lamps

Designed
in 1999

A family of multiple suspension lamps, available with 7, 13 or 19 points of light. It is available in two versions: the Ildē Max S has a metallic structure and is available in two finishes: matte chrome with a red textile cable, or a texturised bronze finish with a black textile cable. The Ildē Wood Max S is made of oak, and features a brown textile cable.

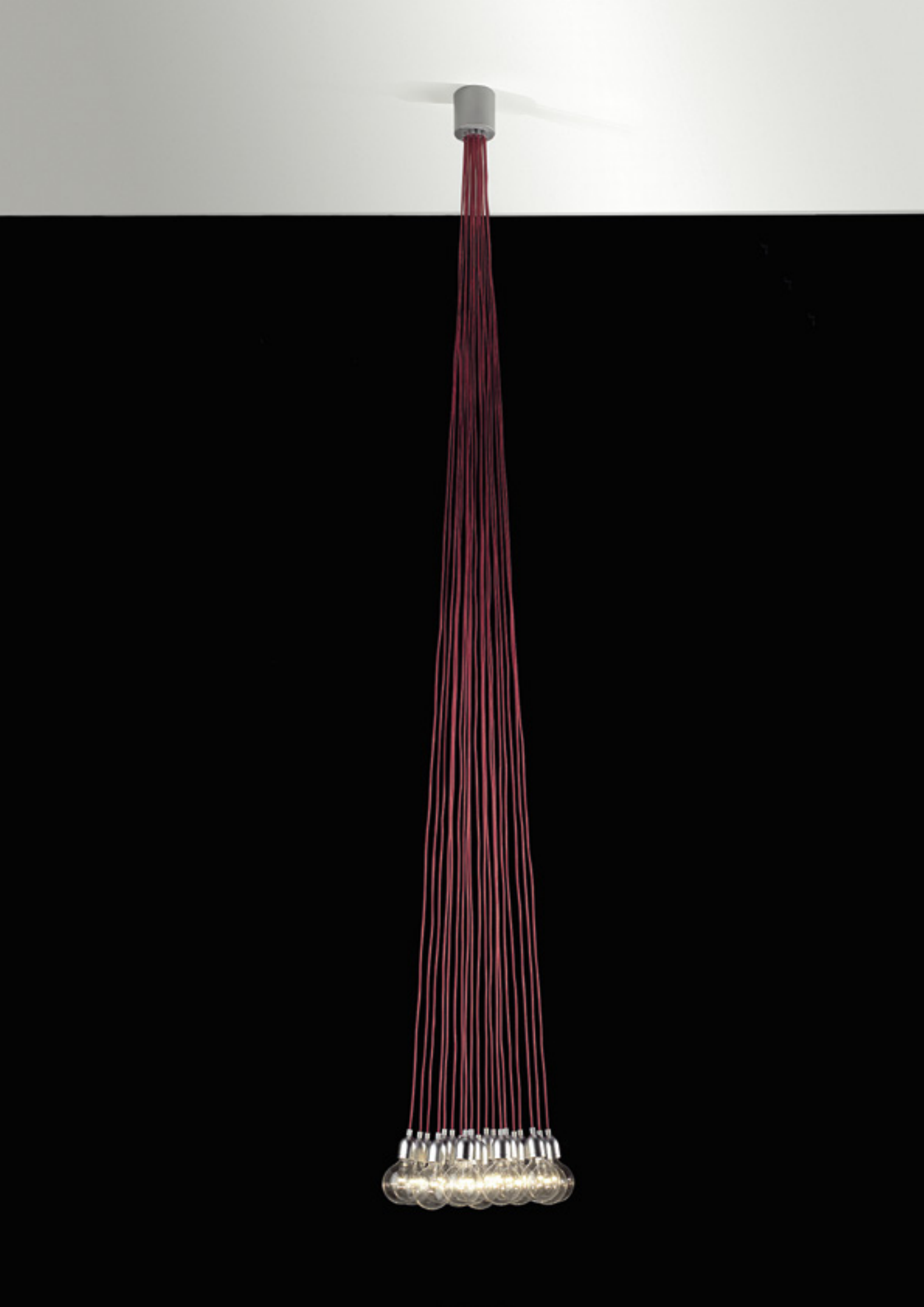



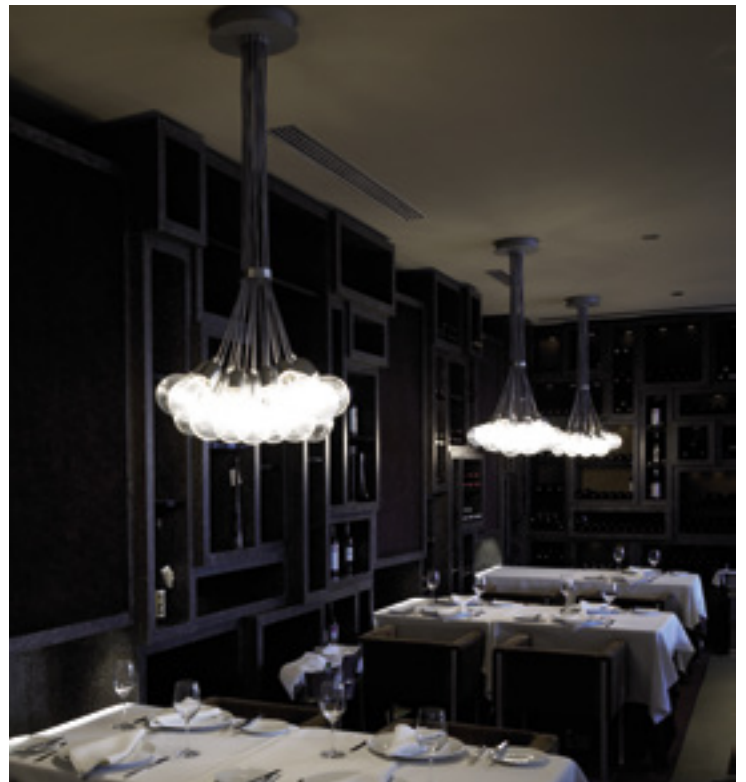

Ildé Max



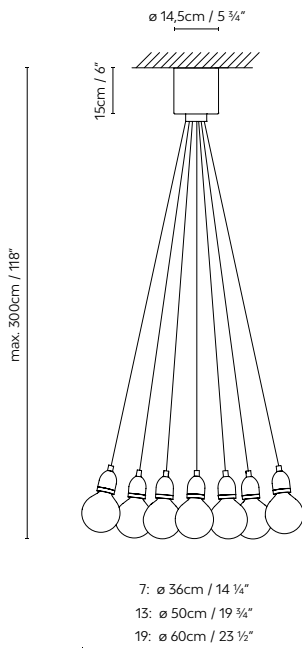

ILDE MAX / ILDE WOOD MAX



ILDE MAX S:  Chrome (matte)  Bronze (texturised)
ILDE WOOD MAX S:  Natural Oak

700301U	ILDE MAX S7 CHROME	LED filament G125 7 x 2W (E26) /
700304U	ILDE MAX S7 BRONZE	Inc. G125 7 x 18W (E26)
700311U	ILDE MAX S13 CHROME	LED filament G125 13 x 2W (E26) /
700314U	ILDE MAX S13 BRONZE	Inc. G125 13 x 18W (E26)
700321U	ILDE MAX S19 CHROME	LED filament G125 19 x 2W (E26) /
700324U	ILDE MAX S19 BRONZE	Inc. G125 19 x 18W (E26)
700305U	ILDE WOOD MAX S7	LED filament G125 7 x 2W (E26) / Inc. G125 7 x 18W (E26) / Inc. Vintage 7 x max.40W (E26)
700315U	ILDE WOOD MAX S13	LED filament G125 13 x 2W (E26) / Inc. G125 13 x 18W (E26) / Inc. Vintage 13 x max.40W (E26)
700325U	ILDE WOOD MAX S19	LED filament G125 19 x 2W (E26) / Inc. G125 19 x 18W (E26) / Inc. Vintage 19 x max.40W (E26)

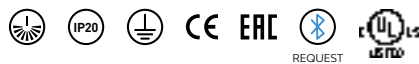

B.lux

Ireland

by
Stone Designs

**Decorative
lighting**

Suspension
lamps

Three-color suspension lamp. Consists of three light bodies with a ceramic shade. The bodies' heights can be independently adjusted. Finish: earth, stone and sand, all in texturized matte, with shade interiors in satin white. Available in two sizes. Optional monochromatic version.



IRELAND S20

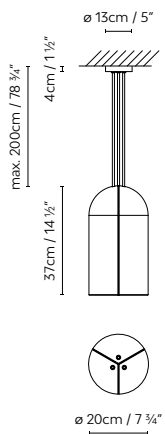

IRELAND S30

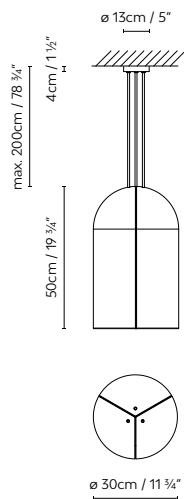

● ● ● Earth (matte) / Stone (matte) / Sand (matte)

741311U
741312U

IRELAND S20
IRELAND S30

LED 3 x 15W (E26) /
Fluo. CFL 3 x max. 30W (E26)
/ Inc. 3 x max. 100W (E26)



B.lux

Keshi

by
David Abad

**Decorative
lighting**

Suspension
lamps

Suspension lamp crafted in sanded black
Markina marble and metallic bar shade,
finished in matte black. Available in two sizes.



Keshi





KESHI S30

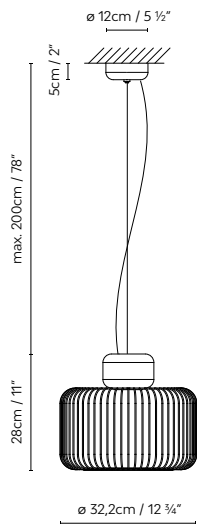

KESHI S50

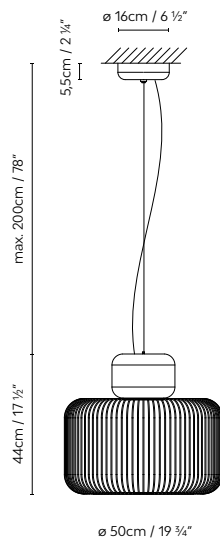

● Black Markina marble (matte)

732351U **KESHI S30** LED 6W (E12) / Fluo. CFL max. 12W (E12) / Inc. max. 40W (E12)

732350U **KESHI S50** LED 6W (E12) / Fluo. CFL max. 12W (E12) / Inc. max. 40W (E12)



REQUEST

LESTO



B.lux

Lite Hole

by
David Abad

**Decorative
lighting**

Suspension
lamps

Large suspension lamp consisting of two concentric aluminum hoops that make up a short, circular lighting body. It is manufactured in two large sizes, with diameters of 120 and 90 centimeters, as well as in a 60-cm size. They all feature an acrylic opal diffuser that hides a direct-emitting and dimmable LED light source that is completely glare-free. Lite Hole is available in matte white, matte black, copper and gold.



Lite Hole





LITE HOLE S60

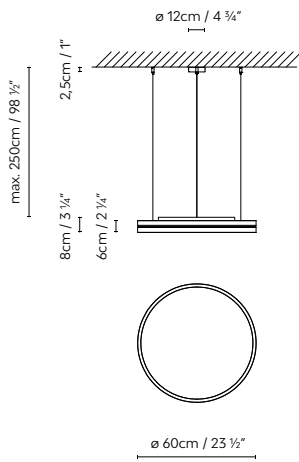

LITE HOLE S90

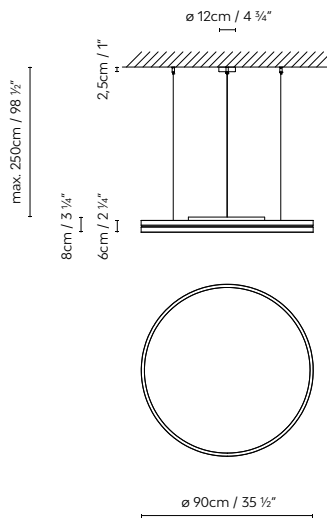

LITE HOLE S120

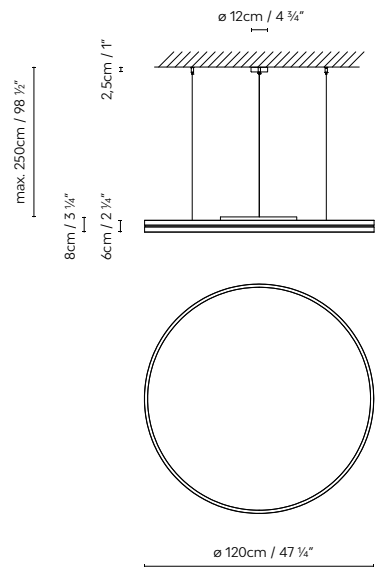

○ White (matte) ● Black (matte) ● Gold ● Copper

755311U **LITE HOLE S60** WHITE
 755312U **LITE HOLE S60** BLACK
 755313U **LITE HOLE S60** GOLD
 755314U **LITE HOLE S60** COPPER
 LED 17,4W 3416lm 150mA 3000K CRI≥90 110-277V DIM 1-10V

755331U **LITE HOLE S90** WHITE
 755332U **LITE HOLE S90** BLACK
 755333U **LITE HOLE S90** GOLD
 755334U **LITE HOLE S90** COPPER
 LED 41W 7960lm 350mA 3000K CRI≥90 110-277V DIM 1-10V

755351U **LITE HOLE S120** WHITE
 755352U **LITE HOLE S120** BLACK
 755353U **LITE HOLE S120** GOLD
 755354U **LITE HOLE S120** COPPER
 LED 19,5W 3664lm 225mA + LED 41W 7960lm 350mA 3000K CRI≥90 110-277V DIM 1-10V



B.lux

Lite Square

by
David Abad

**Decorative
lighting**

Suspension
lamps

Suspension lamp with diffused and adjustable LED light.

Lite Square features two concentric metal profiles that stand out for their tiny size, only 6 cm thick. Made in two square sizes, of 60x60 cm or 110x110 cm, and in a rectangular size of 110x60 cm. They are all available in matte white, matte black, copper and gold. They all have an opal acrylic diffuser.



LITE SQUARE S60x60

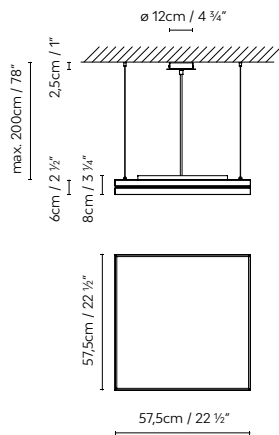

LITE SQUARE S110x60

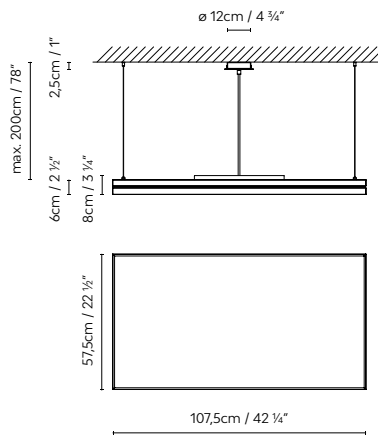

LITE SQUARE S110x110

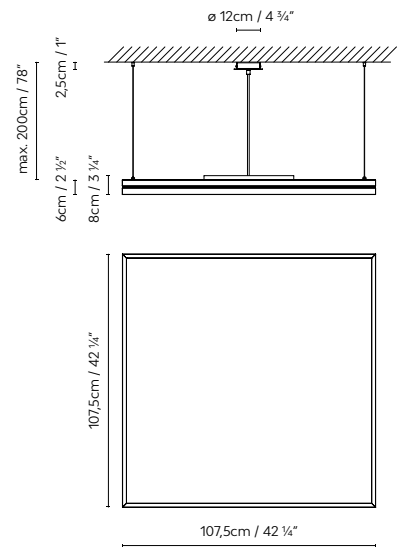

○ White (matte) ● Black (matte) ● Gold ● Copper

754311U	LITE SQUARE S60x60 WHITE	LED 28,8W 5360lm 350mA 3000K CRI≥90 110-277V DIM 1-10V
754312U	LITE SQUARE S60x60 BLACK	
754313U	LITE SQUARE S60x60 GOLD	
754314U	LITE SQUARE S60x60 COPPER	

754331U	LITE SQUARE S110x60 WHITE	LED 57,6W 10720lm 350mA 3000K CRI≥90 110-277V DIM 1-10V
754332U	LITE SQUARE S110x60 BLACK	
754333U	LITE SQUARE S110x60 GOLD	
754334U	LITE SQUARE S110x60 COPPER	

754351U	LITE SQUARE S110x110 WHITE	LED 115,2W 21440lm 350mA 3000K CRI≥90 110-277V DIM 1-10V
754352U	LITE SQUARE S110x110 BLACK	
754353U	LITE SQUARE S110x110 GOLD	
754354U	LITE SQUARE S110x110 COPPER	

B.lux

Misko

by
Stone Designs

**Decorative
lighting**

Suspension
lamps

Japanese-inspired single or multiple suspension lamp, all of them created around a disc that houses the light source (E26). This disc is available in a walnut or painted matte black finish, which supports the textured blown-glass diffuser that comes in an opal matte white finish. The single-unit suspension lamps have one glass diffuser and are available in three sizes (S15, S25 and S35). The multiple-unit lamps allow for different configurations, since the customer can choose to set them up with two glass diffusers (S2 Glass) or three (S3 Glass). Black textile cable.



Misko



MISKO S15

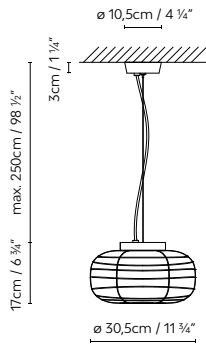

MISKO S25

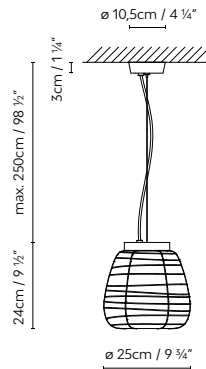

MISKO S35

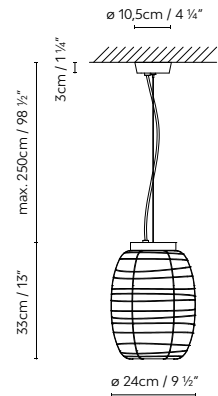

MISKO S2 GLASS

Example: (S35 Superior + S15 Inferior)

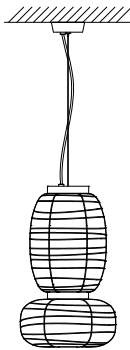

MISKO S3 GLASS

Example: (S25 Superior + S15 Intermediate + S35 Inferior)

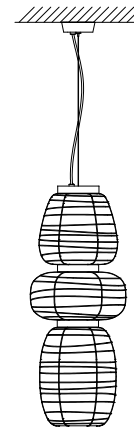

* The multiple-suspension lamps allow for different compositions, with two (S2 glass) or three (S3 glass) diffusers, at the customer's discretion.

● Black (matte) ● Natural Walnut

756305U	MISKO S15 BLACK	LED 10W (E26) / Fluo.
756306U	MISKO S25 BLACK	CFL max. 11W (E26) / Inc. max 60W (E26)
756307U	MISKO S35 BLACK	
756315U	MISKO S15 BLACK SUPERIOR	LED 10W (E26) / Fluo.
756316U	MISKO S25 BLACK SUPERIOR	CFL max. 11W (E26) / Inc. max 60W (E26)
756317U	MISKO S35 BLACK SUPERIOR	
756325U	MISKO S15 BLACK INTERMEDIATE	LED 10W (E26) / Fluo.
756326U	MISKO S25 BLACK INTERMEDIATE	CFL max. 11W (E26) / Inc. max 60W (E26)
756327U	MISKO S35 BLACK INTERMEDIATE	
756335U	MISKO S15 BLACK INFERIOR	LED 10W (E26) / Fluo.
756336U	MISKO S25 BLACK INFERIOR	CFL max. 11W (E26) / Inc. max 60W (E26)
756337U	MISKO S35 BLACK INFERIOR	

756303U	MISKO S15 WALNUT	LED 10W (E26) / Fluo.
756304U	MISKO S25 WALNUT	CFL max. 11W (E26) / Inc. max 60W (E26)
756308U	MISKO S35 WALNUT	
756313U	MISKO S15 WALNUT SUPERIOR	LED 10W (E26) / Fluo.
756314U	MISKO S25 WALNUT SUPERIOR	CFL max. 11W (E26) / Inc. max 60W (E26)
756318U	MISKO S35 WALNUT SUPERIOR	
756323U	MISKO S15 WALNUT INTERMEDIATE	LED 10W (E26) / Fluo.
756324U	MISKO S25 WALNUT INTERMEDIATE	CFL max. 11W (E26) / Inc. max 60W (E26)
756328U	MISKO S35 WALNUT INTERMEDIATE	
756333U	MISKO S15 WALNUT INFERIOR	LED 10W (E26) / Fluo.
756334U	MISKO S25 WALNUT INFERIOR	CFL max. 11W (E26) / Inc. max 60W (E26)
756338U	MISKO S35 WALNUT INFERIOR	

B.lux

Nite

by
Jorge Pensi

Decorative
lighting

Suspension
lamps

Designed
in 2000

Blown glass suspension lamp.

Available with an opaline white
shade with a silver textile cable.



NITE S1

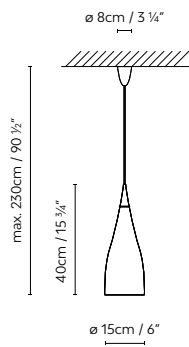

NITE S2

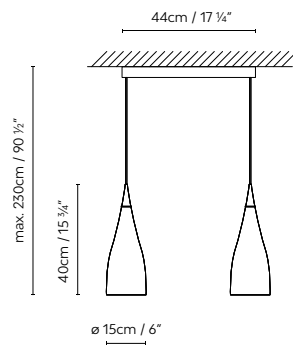

NITE S3

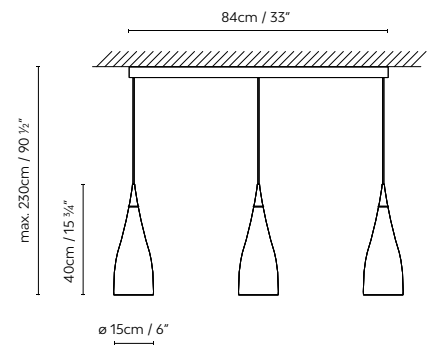

○ Opal white

619300U	NITE S1 OPAL	LED 13W (E26) / Flu. CFL 23W (E26) / Inc. max. 100W (E26)
619310U	NITE SINGLE SUSPENSION	LED 13W (E26) / Flu. CFL 23W (E26) / Inc. max. 100W (E26)
619320U	NITE TRACK 2E	
619330U	NITE TRACK 3E	



REQUEST

UL LISTED

B.lux

Overlay

by
e27, Tim Brauns

**Decorative
lighting**

Suspension
lamps

Blown glass suspension lamp equipped with three detachable conical reflectors, making it possible to adjust the lighting effect as desired. The glass with a cognac-colored finish, is combined with two reflectors in matte beige, copper, grey-beige and yellow. The glass with a grey finish comes with reflectors in beige, dark blue and light blue, all of them matte. Grey textile cable. Available in three sizes.



Overlay





OVERLAY S25

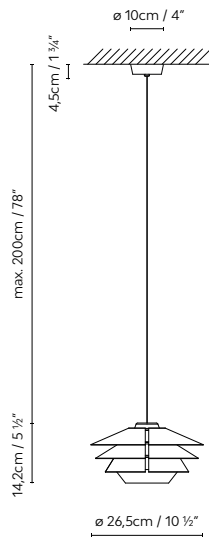

OVERLAY S50

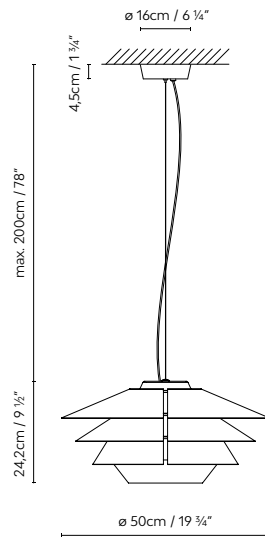

OVERLAY S65

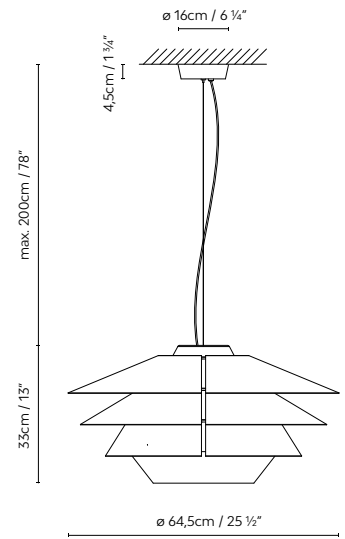

- Cognac glass

 Beige / Copper / Beige (matte)
- Cognac glass

 Yellow / Grey-Beige / Beige (matte)

- Grey glass

 Beige / Beige / Beige (matte)
- Grey glass

 Dark Blue / Light Blue / Beige (matte)

734302U	OVERLAY S25 COGNAC GLASS - BEIGE/COPPER/BEIGE	
734303U	OVERLAY S25 COGNAC GLASS - YELLOW/GREY-BEIGE/BEIGE	LED 5W (E12) / Fluo. CFL max. 11W (E12) / Inc. max. 60W (E12)
734304U	OVERLAY S25 GREY GLASS - BEIGE/BEIGE/BEIGE	
734305U	OVERLAY S25 GREY GLASS - DARK BLUE/LIGHT BLUE/BEIGE	
734312U	OVERLAY S50 COGNAC GLASS - BEIGE/COPPER/BEIGE	
734313U	OVERLAY S50 COGNAC GLASS - YELLOW/GREY-BEIGE/BEIGE	LED 11W (E26) / Fluo. CFL max. 20W (E26) / Inc. max. 70W (E26)
734314U	OVERLAY S50 GREY GLASS - BEIGE/BEIGE/BEIGE	
734315U	OVERLAY S50 GREY GLASS - DARK BLUE/LIGHT BLUE/BEIGE	
734322U	OVERLAY S65 COGNAC GLASS - BEIGE/COPPER/BEIGE	
734323U	OVERLAY S65 COGNAC GLASS - YELLOW/GREY-BEIGE/BEIGE	LED 11W (E26) / Fluo. CFL max. 20W (E26) / Inc. max. 70W (E26)
734324U	OVERLAY S65 GREY GLASS - BEIGE/BEIGE/BEIGE	
734325U	OVERLAY S65 GREY GLASS - DARK BLUE/LIGHT BLUE/BEIGE	

B.lux

Phi

by
David Abad

**Decorative
lighting**

Suspension
lamps

A Scandinavian-inspired suspension lamp with a metallic structure and ABS. Textured matte white finish with textile cable in the same tone. Available in three sizes.



PHI S40

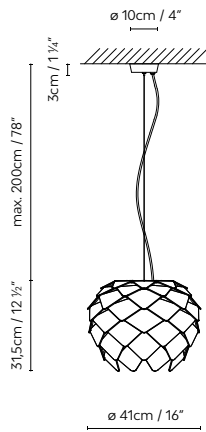

PHI S60

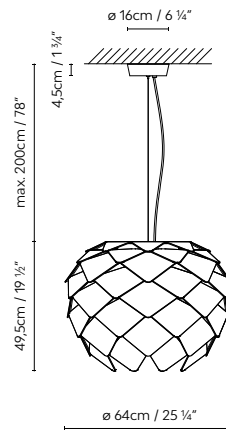

PHI S80

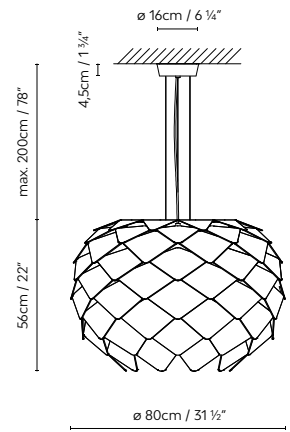

○ White (matte)

725340U	PHI S40	LED glob. 9W (E26) / Fluo. CFL glob. max. 23W (E26) / Inc. max. 70W (E26)
725330U	PHI S60	LED glob. 16W (E26) / Fluo. CFL glob. max. 23W (E26) / Inc. max. 150W (E26)
725320U	PHI S80	LED glob. 3 x 16W (E26) / Fluo. CFL glob. 3 x max. 23W (E26) / Inc. 3 x max. 100W (E26)



B.lux

Quadrat

by
Jorge Pensi

**Decorative
lighting**

Suspension
lamps

Square suspension lamp, crafted in laminated oak. Available in three finishes: matte white, wenge and natural oak. Lower shade made from heat-shrunk film, and upper shade from polycarbonate



QUADRAT S60x60

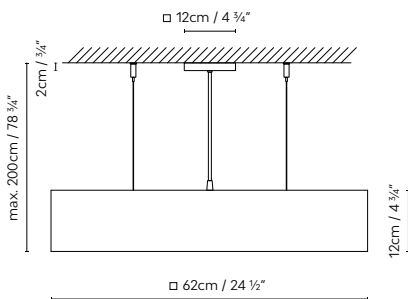

- White ● Natural Oak ● Wenge

- 661311U **QUADRAT S60x60** FLUO WHITE
 661310U **QUADRAT S60x60** FLUO OAK
 661315U **QUADRAT S60x60** FLUO WENGE

Fluo. 4 x 14W (G5) / LED 4 x 7W (G5)



B.lux

R2

by
David Abad

**Decorative
lighting**

Suspension
lamps

Suspension lamp in aluminum featuring a ring design, and with a flat canopy that allows you to hang the R2 from lower ceilings. R2 have LED spotlight modules that provide direct and uniform lighting. There is a second R2 model with flat canopy and indirect light called up/down (R2 S90 / R2 S120). R2 is available with the following finishes: matte white, matte black, matte bronze, natural oak and natural walnut. Made in three sizes (S60, S90 and S120).



R2



R2 S60 FLAT CANOPY

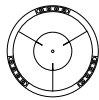
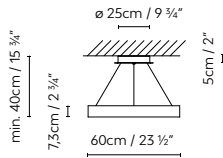

R2 S90 FLAT CANOPY /
R2 S90 FLAT CANOPY UP/DOWN

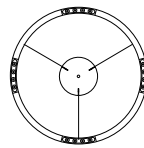
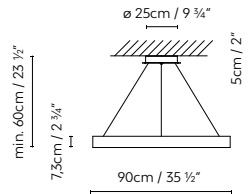

R2 S120 FLAT CANOPY /
R2 S120 FLAT CANOPY UP/DOWN

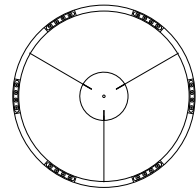
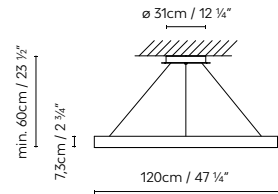

743310FU	R2 S60 FLAT CANOPY WHITE	
743311FU	R2 S60 FLAT CANOPY BRONZE	
743312FU	R2 S60 FLAT CANOPY BLACK	LED 3 x 18W 7879lm 250mA 3000K CRI≥90 110-277V DIM PUSH/1-10V
743313FU	R2 S60 FLAT CANOPY OAK	
743314FU	R2 S60 FLAT CANOPY WALNUT	
743320FU	R2 S90 FLAT CANOPY WHITE	
743321FU	R2 S90 FLAT CANOPY BRONZE	
743322FU	R2 S90 FLAT CANOPY BLACK	LED 4 x 18W 9755lm 250mA 3000K CRI≥90 110-277V DIM PUSH/1-10V
743323FU	R2 S90 FLAT CANOPY OAK	
743324FU	R2 S90 FLAT CANOPY WALNUT	
743330FU	R2 S120 FLAT CANOPY WHITE	
743331FU	R2 S120 FLAT CANOPY BRONZE	
743332FU	R2 S120 FLAT CANOPY BLACK	LED 6 x 18W 15758lm 250mA 3000K CRI≥90 110-277V DIM PUSH/1-10V
743333FU	R2 S120 FLAT CANOPY OAK	
743334FU	R2 S120 FLAT CANOPY WALNUT	
743320FIU	R2 S90 FLAT CANOPY UP/DOWN WHITE	
743321FIU	R2 S90 FLAT CANOPY UP/DOWN BRONZE	DOWN: LED 4 x 18W 9755lm 250mA 3000K CRI≥90 110-277V DIM PUSH/1-10V
743322FIU	R2 S90 FLAT CANOPY UP/DOWN BLACK	UP: 3 x 4,5W 1638lm 250mA 3000k CRI≥90 110-277V DIM PUSH/1-10V
743323FIU	R2 S90 FLAT CANOPY UP/DOWN OAK	
743324FIU	R2 S90 FLAT CANOPY UP/DOWN WALNUT	
743330FIU	R2 S120 FLAT CANOPY UP/DOWN WHITE	
743331FIU	R2 S120 FLAT CANOPY UP/DOWN BRONZE	DOWN: LED 6 x 18W 15758lm 250mA 3000K CRI≥90 110-277V DIM PUSH/1-10V
743332FIU	R2 S120 FLAT CANOPY UP/DOWN BLACK	UP: 3 x 4,5W 1638lm 250mA 3000k CRI≥90 110-277V DIM PUSH/1-10V
743333FIU	R2 S120 FLAT CANOPY UP/DOWN OAK	
743334FIU	R2 S120 FLAT CANOPY UP/DOWN WALNUT	



REQUEST



B.lux

Roof

by
David Abad

**Decorative
lighting**

Suspension
lamps

Direct light suspension lamp made of aluminum, with glass available in satin silver anodized, or textured white or matte black finishes. Combinable with various accessories: One casing satin silver reflector, a textured matte white reflective housing, a reflective casing laminated in natural oak wood with interior matte white or a reflective housing laminated in natural wood walnut tree with matte black interior.





ROOF S130

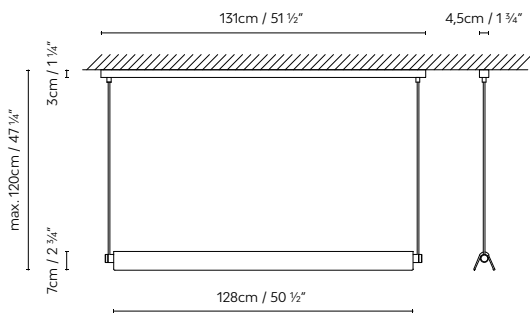

ROOF: ● Silver (satin) ○ White (matte) ● Black (matte)

ACCESSORIES: Casing: ● Aluminum (satin) ● Natural Oak
○ White (matte) ● Natural Walnut



DESIGN PLUS

847300U **ROOF S130 SILVER**
847301U **ROOF S130 WHITE** Fluo. 28W (G5) / LED 17W (G5)
847302U **ROOF S130 BLACK**

847905U **ROOF S130 ACCESSORY: CASING ALUMINUM**
847903U **ROOF S130 ACCESSORY: CASING WHITE**
847910U **ROOF S130 ACCESSORY: CASING OAK**
847911U **ROOF S130 ACCESSORY: CASING WALNUT**

847350U **ROOF S160 SILVER**
847351U **ROOF S160 WHITE** Fluo. 35W (G5) / LED 18W (G5)
847352U **ROOF S160 BLACK**

847955U **ROOF S160 ACCESSORY: CASING ALUMINUM**
847953U **ROOF S160 ACCESSORY: CASING WHITE**
847960U **ROOF S160 ACCESSORY: CASING OAK**
847961U **ROOF S160 ACCESSORY: CASING WALNUT**

ROOF S160

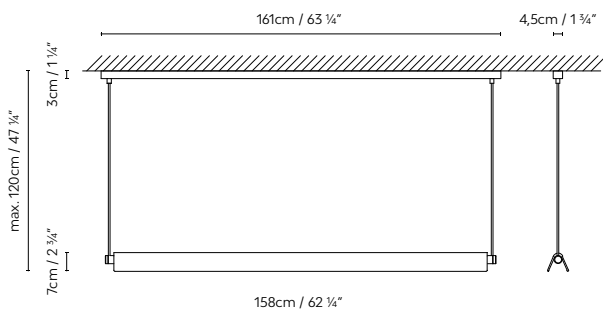

B.lux

Royal

by
David Abad

**Decorative
lighting**

Suspension
lamps

Suspension lamp with a pleated fabric shade.

Available in two versions: Black shade with a textile black cable, or beige shade with a textile brown cable. Available in three sizes.



ROYAL S28

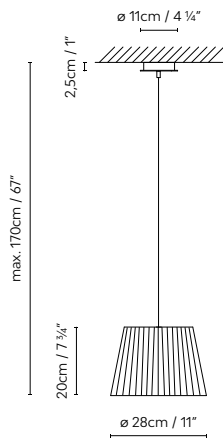

ROYAL S45

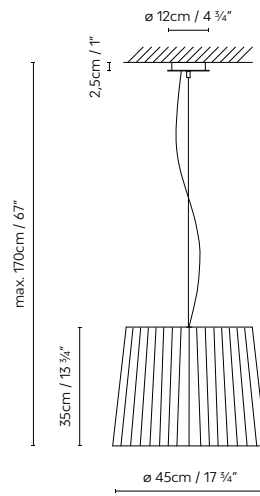

ROYAL S OVERSIZE

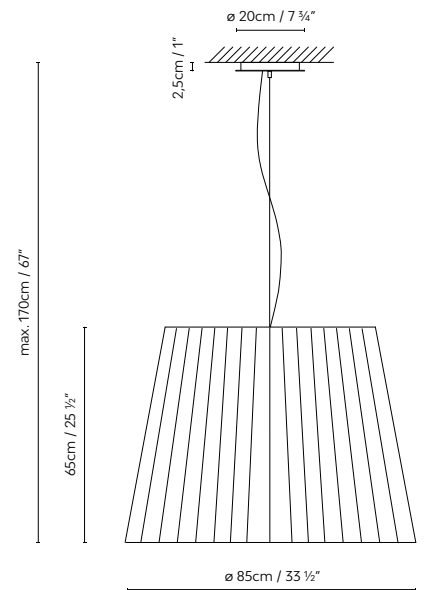

● Black ● Beige

704300U **ROYAL S28 BLACK** LED 12W (E26) / Flu. CFL max. 23W (E26) / Inc. max. 70W (E26)
 704301U **ROYAL S28 BEIGE**

704310U **ROYAL S45 BLACK** LED 2 x 12W (E26) / Flu. CFL 2 x max. 23W (E26) / Inc. 2 x max. 70W (E26)
 704311U **ROYAL S45 BEIGE**

704320U **ROYAL S OVERSIZE BLACK** LED 4 x 12W (E26) / Flu. CFL 4 x max. 23W (E26) / Inc. 4 x max. 70W (E26)
 704321U **ROYAL S OVERSIZE BEIGE**

B.lux

Scout

by
Stone Designs

**Decorative
lighting**

Suspension
lamps



Adjustable suspension lamp with a metal structure and opaline glass diffuser. Available in beige, red and grey with a shade colored textile cable, plus a palette of RAL colors with a textile black cable, all of them with a matte finish and matte white on the inside. Available in two sizes.



Scout





SCOUT S22

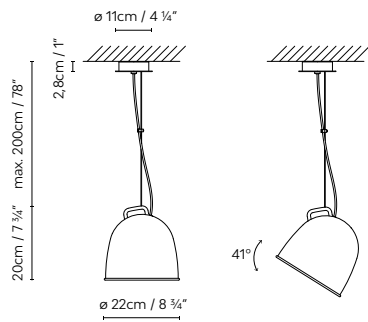

SCOUT S40

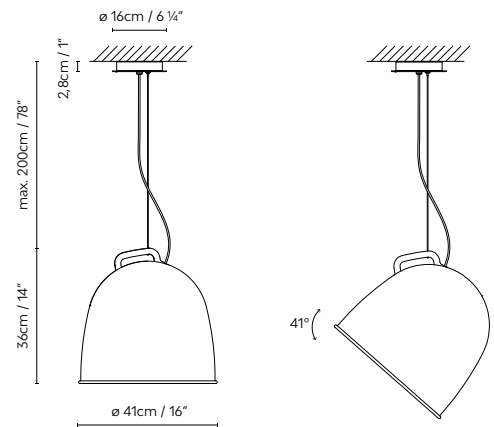

● Beige (matte) ● Red (matte) ● Grey (matte)

○ RAL 9003 (matte) ● RAL 1034 (matte) ● RAL 4004 (matte) ● RAL 3015 (matte)
 ● RAL 1012 (matte) ● RAL 6034 (matte) ● RAL 5017 (matte) ● RAL 7035 (matte)
 ● RAL 7037 (matte) ● RAL 5024 (matte) ● RAL 5012 (matte) ● RAL 7021 (matte)

726350U **SCOUT S22** (E12) BEIGE
 726351U **SCOUT S22** (E12) RED
 726352U **SCOUT S22** (E12) GREY
 726353U **SCOUT S22** (E12) +

LED 2 x 5W (E12) / Fluo. CFL 2 x max. 11W (E12) / Inc. 2 x max. 40W (E12)

726300U **SCOUT S40** (E26) BEIGE
 726301U **SCOUT S40** (E26) RED
 726302U **SCOUT S40** (E26) GREY
 726303U **SCOUT S40** (E26) +

LED 2 x 11W (E26) / Fluo. CFL 2 x max. 20W (E26) / Inc. 2 x max. 70W (E26)



B.lux

Skin

by
AIA Salazar-Navarro

**Decorative
lighting**

Suspension
lamps

Suspension lamp (S) made out of opal white polymethacrylate, coated in a stainless steel, cylindrical metal mesh, lacquered in steel or satin bronze finishes. Plug-in version available with a connector (SC), with 2.5 m of cable.



Skin



SKIN S70

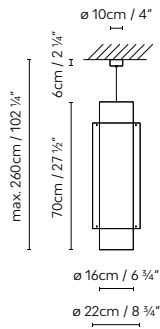

SKIN S100

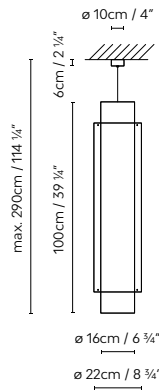

SKIN S130

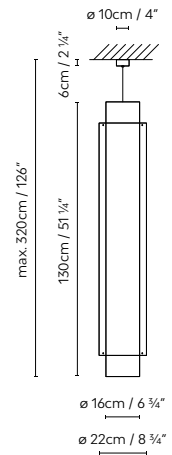

SKIN S160

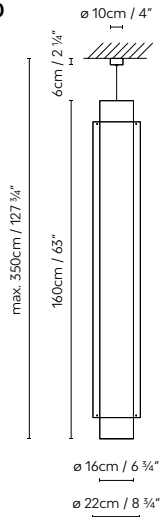

SKIN SC130

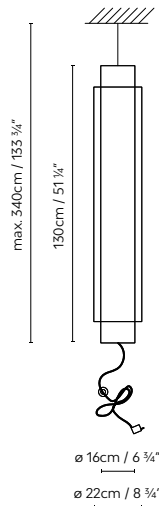

SKIN SC160

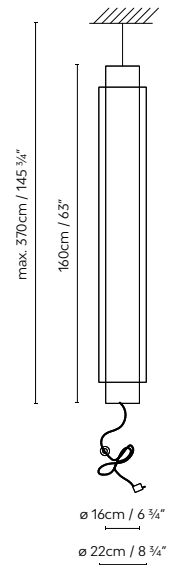

● Steel ● Bronze (satin)

654310U	SKIN S70 FLUO STEEL	Fluo. 2 x 14W (G5) / LED 2 x 7W (G5)
654314U	SKIN S70 FLUO BRONZE	
654320U	SKIN S100 FLUO STEEL	Fluo. 2 x 21W (G5) / LED 2 x 10W (G5)
654324U	SKIN S100 FLUO BRONZE	
654330U	SKIN S130 FLUO STEEL	Fluo. 2 x 28W (G5) / LED 2 x 17W (G5)
654334U	SKIN S130 FLUO BRONZE	
654340U	SKIN S160 FLUO STEEL	Fluo. 2 x 35W (G5) / LED 2 x 18W (G5)
654344U	SKIN S160 FLUO BRONZE	
654335U	SKIN SC130 FLUO STEEL	Fluo. 2 x 28W (G5) / LED 2 x 17W (G5)
654339U	SKIN SC130 FLUO BRONZE	
654345U	SKIN SC160 FLUO STEEL	Fluo. 2 x 35W (G5) / LED 2 x 18W (G5)
654349U	SKIN SC160 FLUO BRONZE	

B.lux

Speers

by
David Abad

**Decorative
lighting**

Suspension
lamps

Suspension lamp system available with different sizes of shade. The S shade is made in copper or brass and available in solid copper or brass finishes, both with a shiny exterior and a satin interior. It is also sold in a textured matte black or white exterior, combined with a shade interior in satin brass or copper. M and L shades are made in aluminum and available in solid textured white or matte black. The Speers single and the multiple fixture lamps (S2, S3, S4, S5 and S6) are available in a surface version and the canopies are always white or black. Speers lamps are equipped with a high-luminance LED light source. They include a glass lens that focuses the light and enhances its luminous efficiency. There is an optional opal diffuser providing general diffused lighting.



Speers



SPEERS S1

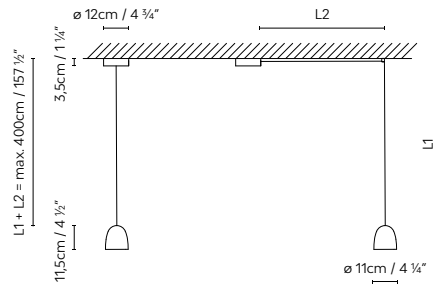

SPEERS S2

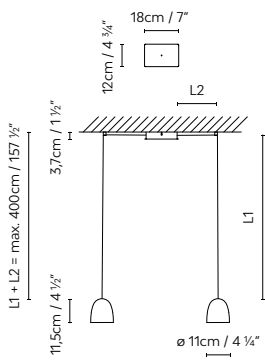

SPEERS S3

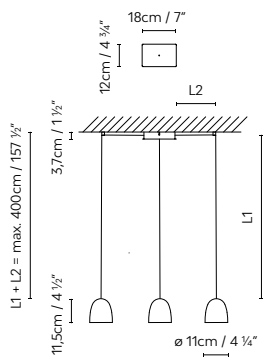



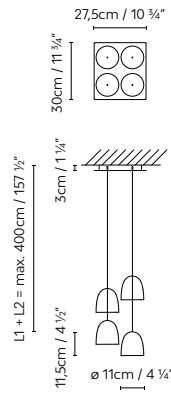

SPEERS S4

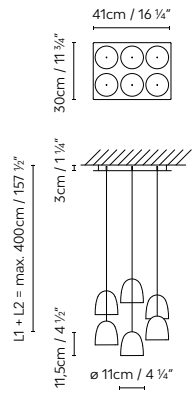



SPEERS S6



-  Copper (shiny) / copper (satin)
-  Brass (shiny) / brass (satin)

-  White (matte) / copper (satin)
-  White (matte) / brass (satin)

-  Black (matte) / copper (satin)
-  Black (matte) / brass (satin)

729300U	SPEERS S1 COPPER-COPPER	
729305U	SPEERS S1 BRASS-BRASS	
729302U	SPEERS S1 BLACK-COPPER	LED 9W 1100lm 500mA
729307U	SPEERS S1 BLACK-BRASS	2700K CRI≥90 110-240V
729301U	SPEERS S1 WHITE-COPPER	DIM PUSH/1-10V
729306U	SPEERS S1 WHITE-BRASS	
729390U	SPEERS SINGLE COPPER+	
729395U	SPEERS SINGLE BRASS+	
729392U	SPEERS SINGLE BLACK-COPPER+	LED 9W 1100lm
729397U	SPEERS SINGLE BLACK-BRASS+	500mA 2700K
729391U	SPEERS SINGLE WHITE-COPPER+	CRI≥90 110-240V
729396U	SPEERS SINGLE WHITE-BRASS+	

729362U	SPEERS S2/S3 CANOPY BLACK+	DIM PUSH/1-10V
729361U	SPEERS S2/S3 CANOPY WHITE+	
729372U	SPEERS S4 CANOPY BLACK+	DIM PUSH/1-10V
729371U	SPEERS S4 CANOPY WHITE+	
729382U	SPEERS S6 CANOPY BLACK+	DIM PUSH/1-10V
729381U	SPEERS S6 CANOPY WHITE+	

Speers



SPEERS S1/M

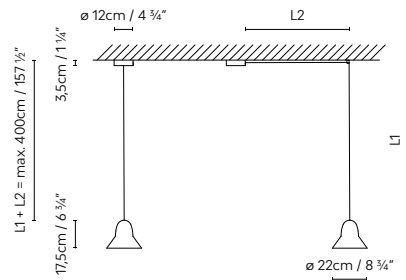

SPEERS S2/M

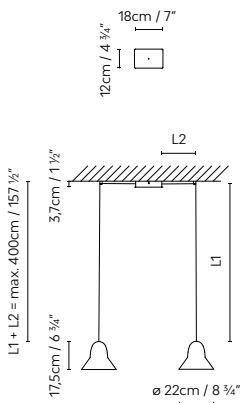

SPEERS S3/M

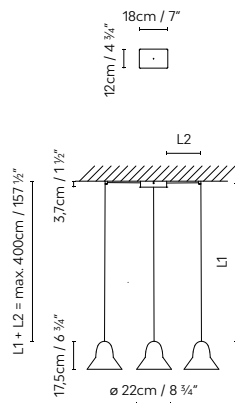

SPEERS S4/M

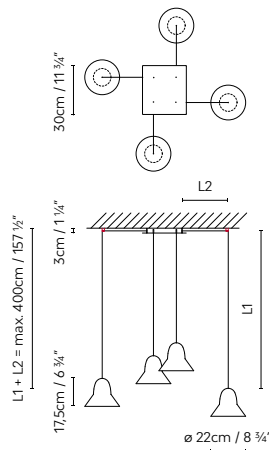

SPEERS S6/M

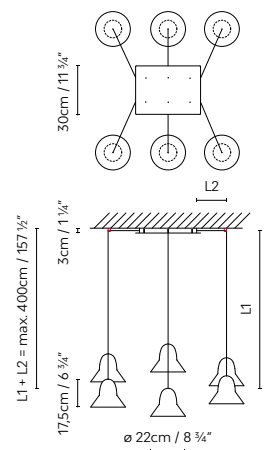

● Black (matte) ○ White (matte)

729332U	SPEERS S1/M BLACK	LED 9W 1100lm 500mA 2700K
729331U	SPEERS S1/M WHITE	CRI≥90 110-240V DIM PUSH/1-10V
729382U	SPEERS SINGLE M BLACK+	LED 9W 1100lm 500mA
729381U	SPEERS SINGLE M WHITE+	2700K CRI≥90 110-240V

729362U	SPEERS S2/S3 CANOPY BLACK+	DIM PUSH-1-10V
729361U	SPEERS S2/S3 CANOPY WHITE+	
729372U	SPEERS S4 CANOPY BLACK+	DIM PUSH-1-10V
729371U	SPEERS S4 CANOPY WHITE+	
729382U	SPEERS S6 CANOPY BLACK+	DIM PUSH-1-10V
729381U	SPEERS S6 CANOPY WHITE+	



Speers



SPEERS S1/L

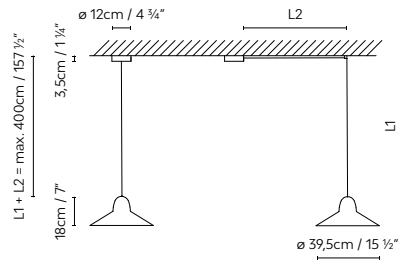

SPEERS S2/L

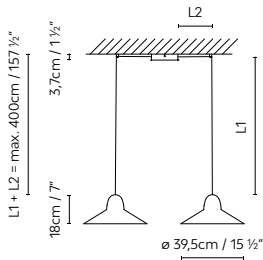

SPEERS S3/L

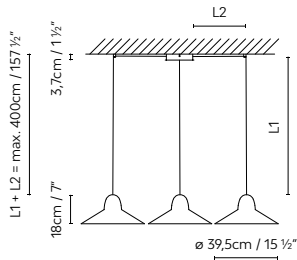

SPEERS S4/L

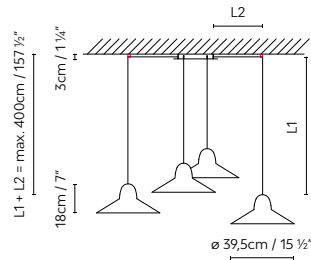
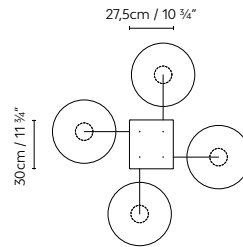

SPEERS S6/L

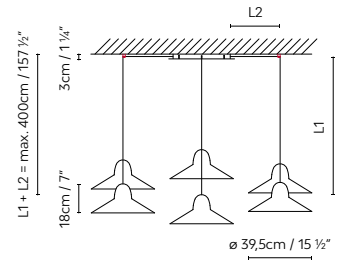
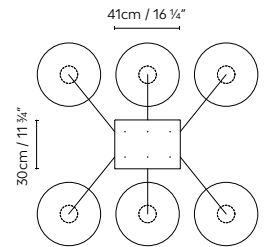

● Black (matte) ○ White (matte)

729337U	SPEERS S1/L BLACK	LED 9W 1100lm 500mA 2700K
729336U	SPEERS S1/L WHITE	CRI≥90 110-240V DIM PUSH/1-10V
729387U	SPEERS SINGLE L BLACK+	LED 9W 1100lm 500mA
729386U	SPEERS SINGLE L WHITE+	2700K CRI≥90 110-240V

729362U	SPEERS S2/S3 CANOPY BLACK+	DIM PUSH-1-10V
729361U	SPEERS S2/S3 CANOPY WHITE+	
729372U	SPEERS S4 CANOPY BLACK+	DIM PUSH-1-10V
729371U	SPEERS S4 CANOPY WHITE+	
729382U	SPEERS S6 CANOPY BLACK+	DIM PUSH-1-10V
729381U	SPEERS S6 CANOPY WHITE+	

B.lux

Tree Series

by
Werner Aisslinger

**Decorative
lighting**

Suspension
lamps

An organic-look suspension lamp with an aluminum shade. Direct and reflected light. Available in textured monochromatic white or black matte finishes, and textured matte two-toned black and white, with a gold interior. Textile cables in the same tone.



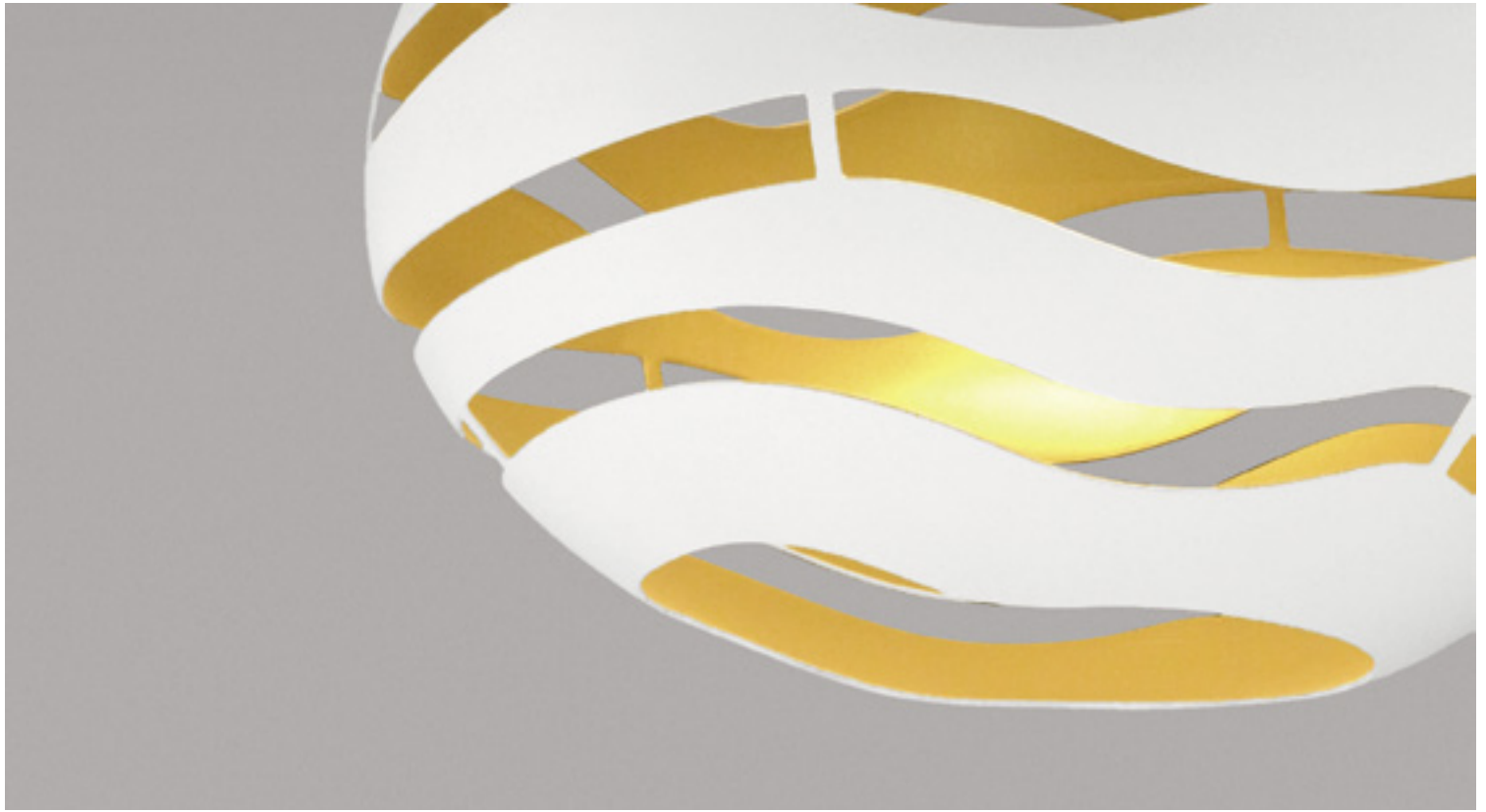

TREE SERIES S50

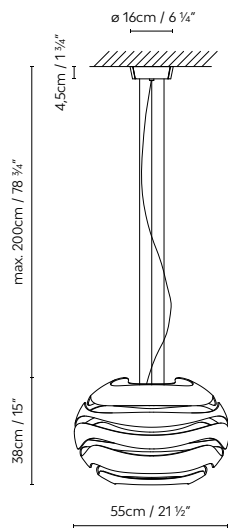

TREE SERIES S75

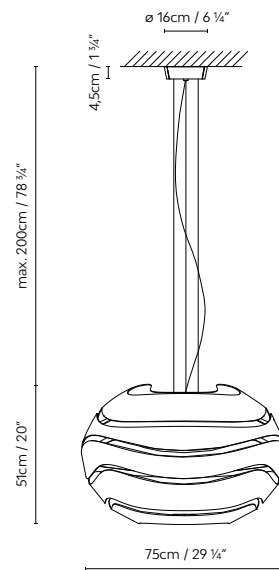

- White (matte) / white (matte)

 Black (matte) / black (matte)
- White (matte) / gold (matte)
 Black (matte) / gold (matte)

701302U **TREE SERIES S50** WHITE-WHITE
 701303U **TREE SERIES S50** BLACK-BLACK
 701301U **TREE SERIES S50** WHITE-GOLD
 701300U **TREE SERIES S50** BLACK-GOLD

LED 11W (E12) / Flu. CFL 23W (E12) / Inc. 60W (E12)

701312U **TREE SERIES S75** WHITE-WHITE
 701313U **TREE SERIES S75** BLACK-BLACK
 701311U **TREE SERIES S75** WHITE-GOLD
 701310U **TREE SERIES S75** BLACK-GOLD

LED 2 x 11W (E12) / Flu. CFL 2 x 23W (E12) / Inc. 2 x 60W (E12)



Floor
lamps



B.lux

Aspen

by
Werner Aisslinger

**Decorative
lighting**

Floor
lamps

Double-shade floor lamps with indirect (F17) and direct (F40) light.

Matte lacquered finishes, with different combinations: grey, snow, lemon, mango, clear turquoise, aqua, merlot, river, sea, rose, limestone, black and brass. Structure and cable in black.





ASPEN F17

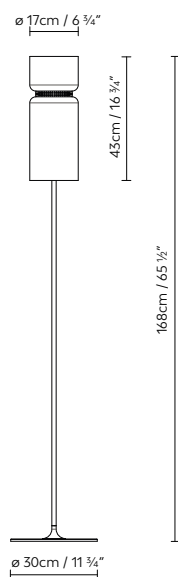

ASPEN F40

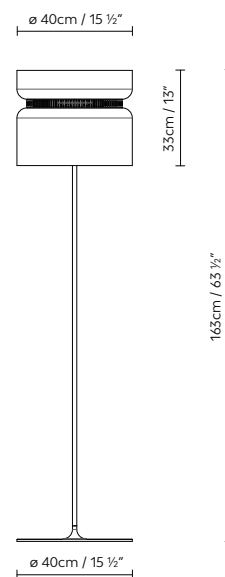

- SHADE:**
- Grey (matte)
 - Mango (matte)
 - Merlot (matte)
 - Rose (matte)
 - Brass (matte)
 - Snow (matte)
 - Clear turquoise (matte)
 - River (matte)
 - Limestone (matte)
 - Lemon (matte)
 - Aqua (matte)
 - Sea (matte)
 - Black (matte)
- RING:**
- Black (matte)

727220U	ASPEN F17	LED 11W (E26) / Fluo. CFL max. 23W (E26) / Inc. max. 70W (E26)
727221U	ASPEN F40	LED 3 x 11W (E26) / Fluo. CFL 3 x max. 23W (E26) / Inc. 3 x max. 70W (E26)

B.lux

Blux System

**Decorative
lighting**

Floor
lamps

Designed
in 1979

Articulated floor lamp designed in the late 70s in the style of the English school. The simplicity of its forms is reflected in its friction swivel joints and aluminum shade. Finishes: matte black, matte red or matte beige, and the inside of the shade in satin white. Also available with brass and copper shades that combine with the body of the lamp in black.





BLUX SYSTEM F30

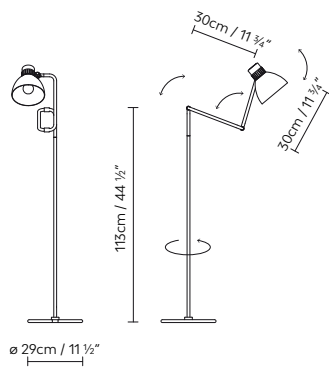

BLUX SYSTEM F50

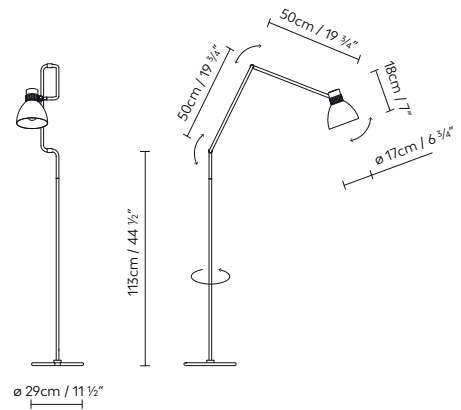

Black (matte)
 Red (matte)
 Beige (matte)

 Brass (matte) / Black (matte)

 Copper (matte) / Black (matte)

736210U	BLUX SYSTEM F30 BLACK	
736211U	BLUX SYSTEM F30 RED	LED 11W (E26) / Flu.
736212U	BLUX SYSTEM F30 BEIGE	CFL max. 13W (E26) /
736213U	BLUX SYSTEM F30 BRASS	Inc. max. 60W (E26)
736214U	BLUX SYSTEM F30 COPPER	

736220U	BLUX SYSTEM F50 BLACK	
736221U	BLUX SYSTEM F50 RED	LED 11W (E26) / Flu.
736222U	BLUX SYSTEM F50 BEIGE	CFL max. 13W (E26) /
736223U	BLUX SYSTEM F50 BRASS	Inc. max. 60W (E26)
736224U	BLUX SYSTEM F50 COPPER	



B.lux

Bowee

by
Werner Aisslinger

**Decorative
lighting**

Floor
lamps

LED floor lamp made with a half-sphere shade and a concrete base. The light source can be adjusted on its horizontal axis and gives direct and diffused light. Available in metallic English bronze, matte turquoise and matte beige.



BOWEE F

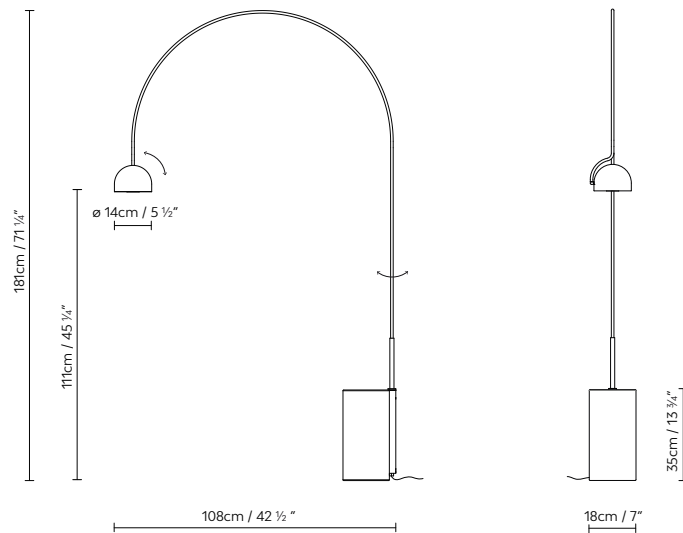

● Beige (matte) ● Clear turquoise (matte) ● Metallic English bronze

758200U
758201U
758202U

BOWEE F BEIGE
BOWEE F CLEAR TURQUOISE
BOWEE F METALLIC ENGLISH BRONZE

LED 6,4W 760lm 350mA 3000K CRI \geq 90

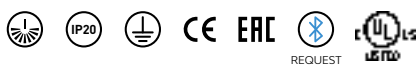

B.lux

C_Ball

by
Stone Designs

**Decorative
lighting**

Floor
lamps

Decorative floor lamp consisting of an opal glass sphere and metal components finished in satin brass or matte black.

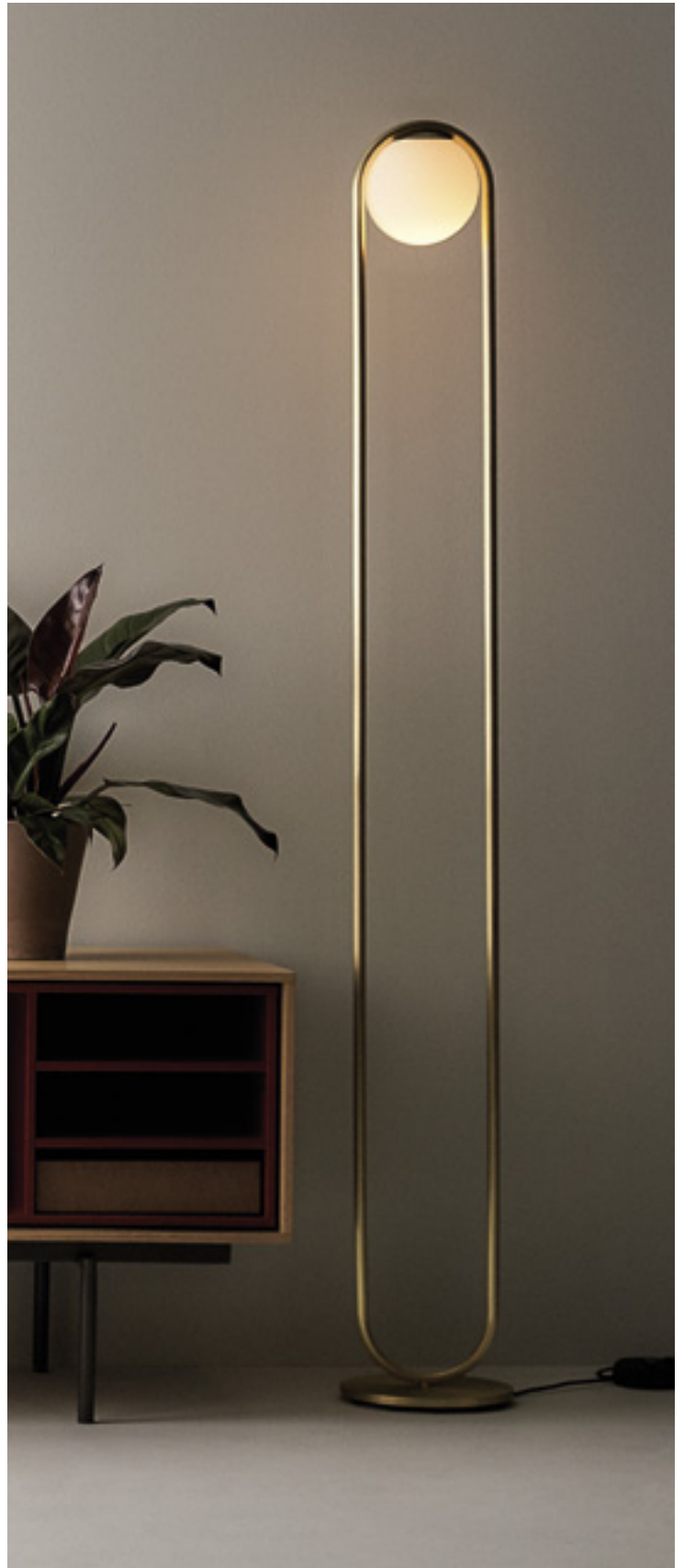
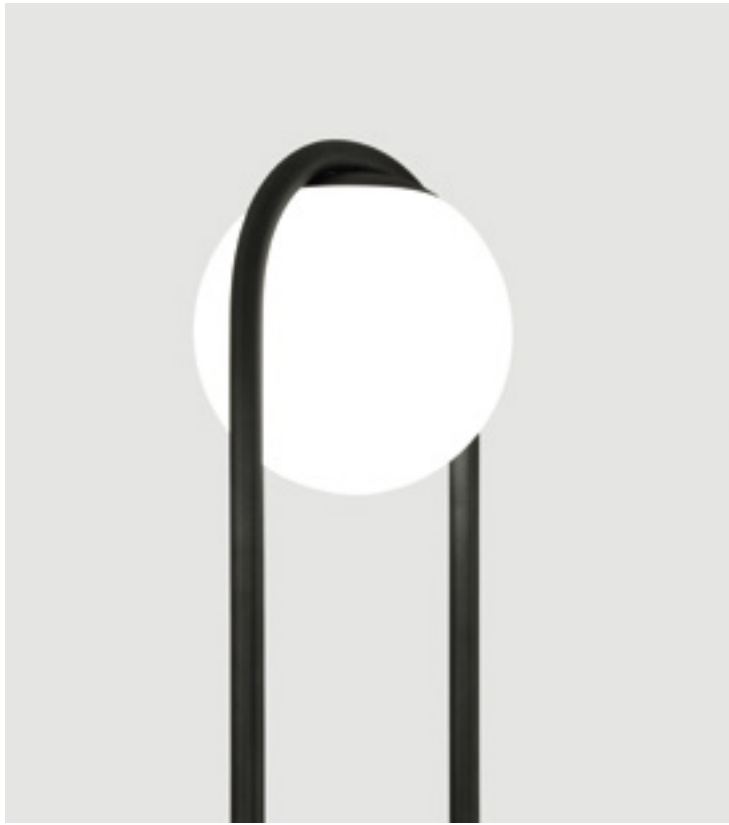

C_BALL F

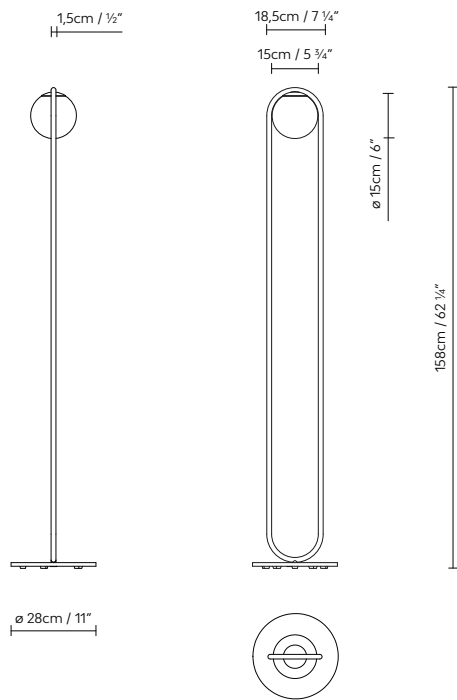

- Brass (satin)
- Black (matte)

748210U
748215U

C_BALL F BRASS
C_BALL F BLACK

LED 6W (E12) / Fluo. CFL max. 12W (E12) / Inc. max. 40W (E12)



REQUEST



C_BALL S p. 44



C_BALL T p. 142



C_BALL W p. 200



C_BALL SYST. p. 224

B.lux

Lola

by
David Abad

**Decorative
lighting**

Floor
lamps

Floor lamp with a metal body and fabric shade. It comes in two finishes: black matte textured body with an opaque black shade, or white matte textured body with an opaque white shade. In both versions, the inside of the shade is gold. Optional black or white cable.



LOLA F

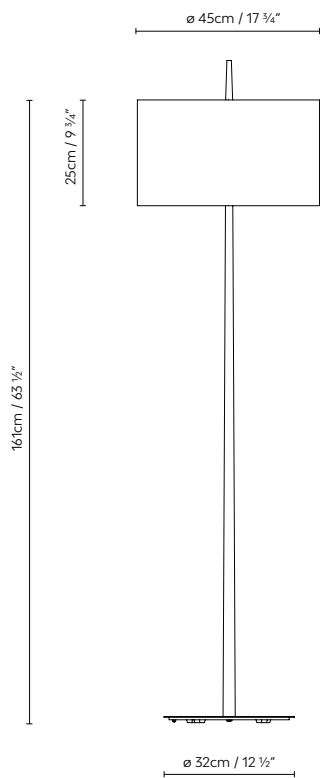

●● Black / gold ○● White / gold

702201U **LOLA F BLACK/GOLD** LED 2 x 11W (E26) / Fluo. CFL
 702202U **LOLA F WHITE/GOLD** 2 x max. 20W (E26) / Inc. 2 x 60W (E26)



B.lux

Misko

by
Stone Designs

**Decorative
lighting**

Floor
lamps

Japanese-inspired floor lamp, available in three sizes (F15, F25 and F35), all of them created around a disc housing the light source (E26). This disc is available in a walnut or painted matte black finish, which supports the textured blown-glass diffuser that comes in an opal matte white finish. Metallic base and shaft painted matte black.

MISKO F15

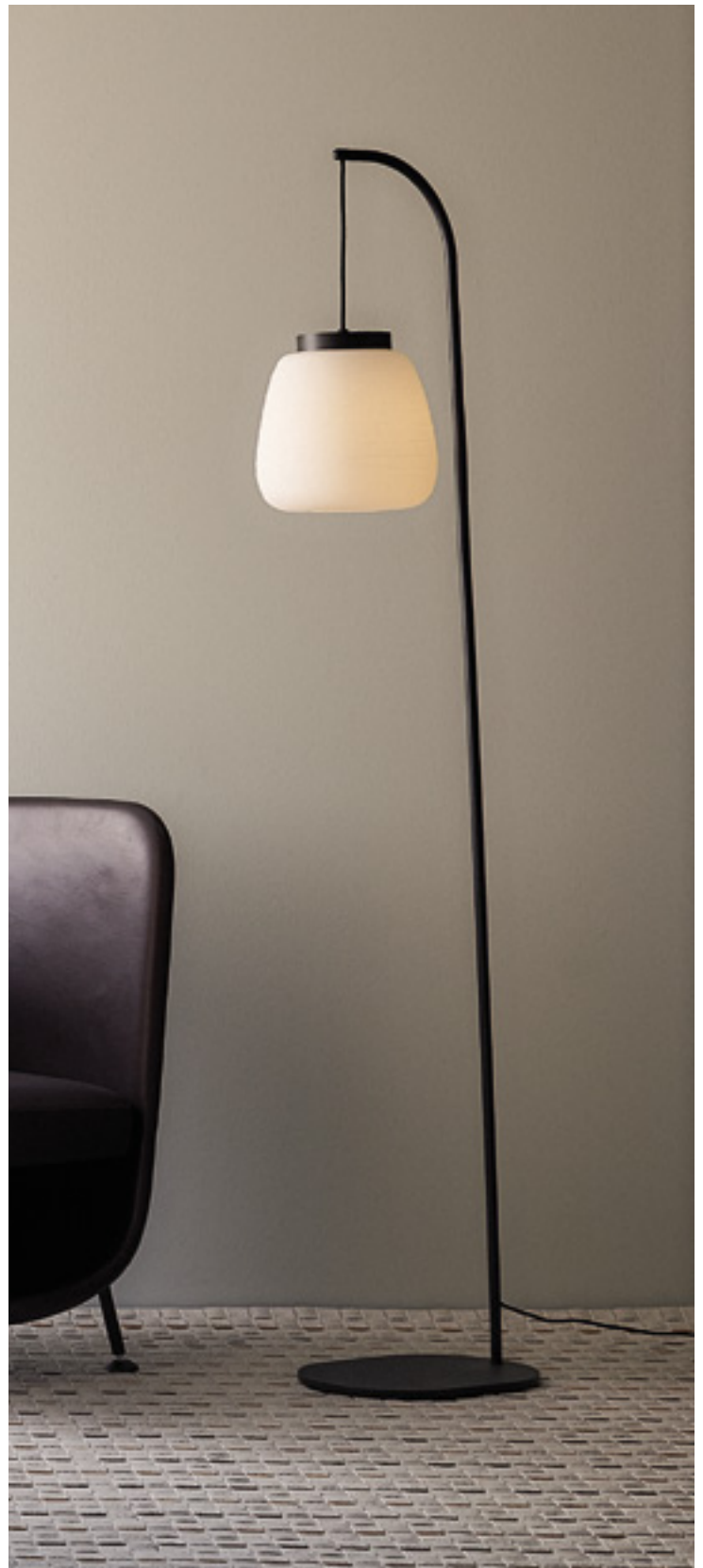
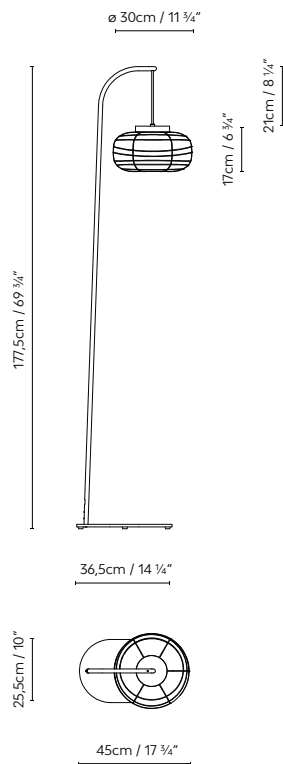

MISKO F25

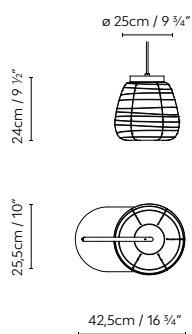

MISKO F35

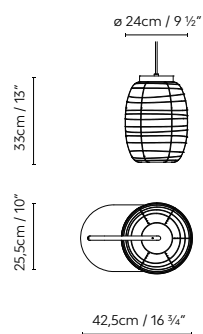

● Black (matte) ● Walnut

756205U **MISKO F15** BLACK LED 10W (E26) / Flu. CFL max.
 756206U **MISKO F25** BLACK 11W (E26) / Inc. max 60W (E26)
 756207U **MISKO F35** BLACK

756203U **MISKO F15** WALNUT LED 10W (E26) / Flu. CFL max.
 756204U **MISKO F25** WALNUT 11W (E26) / Inc. max 60W (E26)
 756208U **MISKO F35** WALNUT



REQUEST



MISKO S p. 76



MISKO T p. 148



MISKO C p. 174



MISKO W p. 206

B.lux

Overlay

by
e27, Tim Brauns

Decorative
lighting

Floor
lamps

Blown glass floor lamp equipped with three detachable conical reflectors, making it possible to adjust the lighting effect as desired. The glass with a cognac-colored finish, is combined with reflectors in matte beige, copper, grey-beige and yellow. The glass with a grey finish comes with reflectors in beige, dark blue and light blue, all of them matte.



OVERLAY F

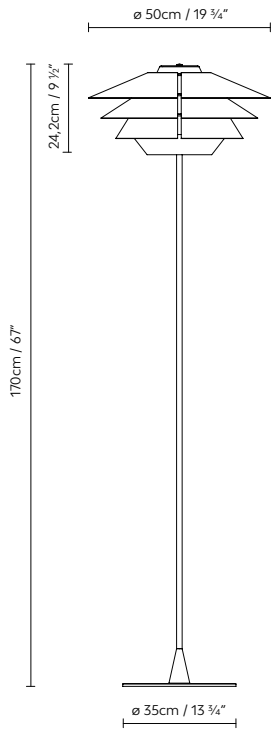

- Cognac glass ● Beige / Copper / Beige (matte)
- Cognac glass ● Yellow / Grey-Beige / Beige (matte)

- Grey glass ● Beige / Beige / Beige (matte)
- Grey glass ● Dark Blue / Light Blue / Beige (matte)

734212U **OVERLAY F** COGNAC GLASS - BEIGE/COPPER/BEIGE
 734213U **OVERLAY F** COGNAC GLASS - YELLOW/GREY-BEIGE/BEIGE
 734214U **OVERLAY F** GREY GLASS - BEIGE/BEIGE/BEIGE
 734215U **OVERLAY F** GREY GLASS - DARK BLUE/LIGHT BLUE/BEIGE

LED 11W (E26) / Flu. CFL max. 20W (E26) / Inc. max. 70W (E26)

B.lux

Royal

by
David Abad

**Decorative
lighting**

Floor
lamps

Floor lamp with stainless steel stand and tripod,
in a satin finish, with pleated fabric shade.
Available in two versions: black shade or beige
shade. Available in two sizes.



ROYAL F

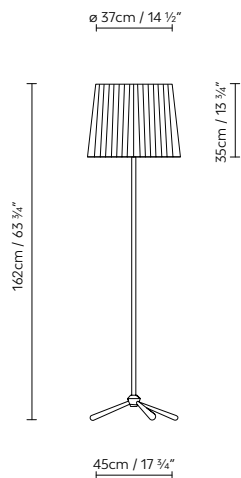

ROYAL F OVERSIZE

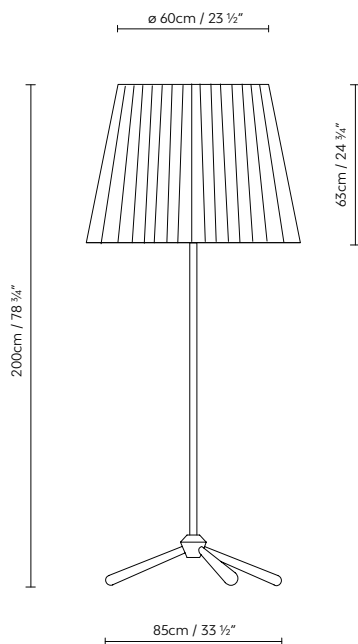

● Black ● Beige

704200U **ROYAL F BLACK** LED 11W (E26) / Fluo. CFL max. 20W (E26) / Inc. max. 100W (E26)
 704201U **ROYAL F BEIGE**

704210U **ROYAL F OVERSIZE BLACK** LED 4 x 15W (E26) / Fluo. CFL 4 x max. 23W (E26) / Inc. 4 x max. 100W (E26)
 704211U **ROYAL F OVERSIZE BEIGE**



B.lux

Speers

by
David Abad

Decorative
lighting

Floor
lamps

Floor lamp featuring a double shaft and two heads, both adjustable. The light source is a high-luminance LED bulb, which includes a glass lens that concentrates the light and enhances its output. Available in two finishes: textured white matte outer finish with a satin brass interior, and textured black matte exterior with satin copper interior. Dual-light.

SPEERS F

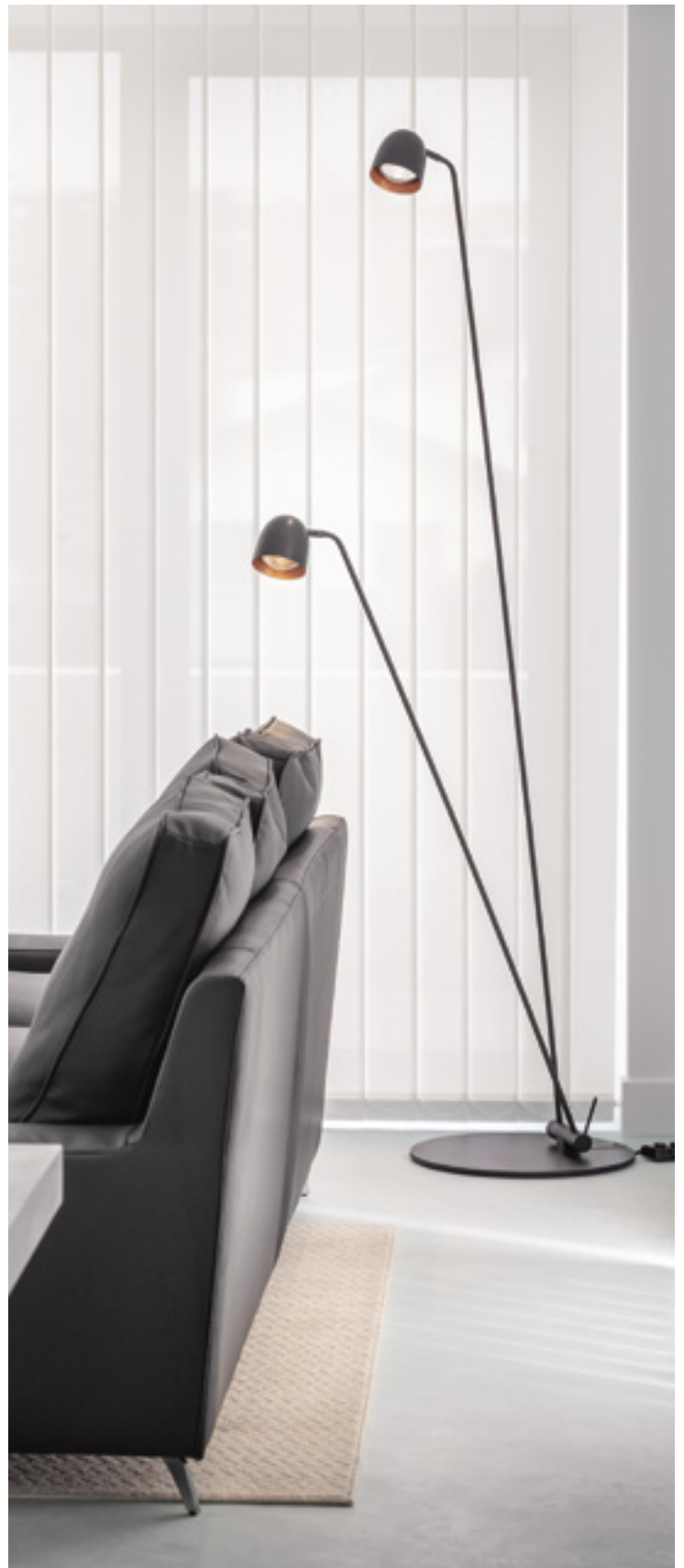
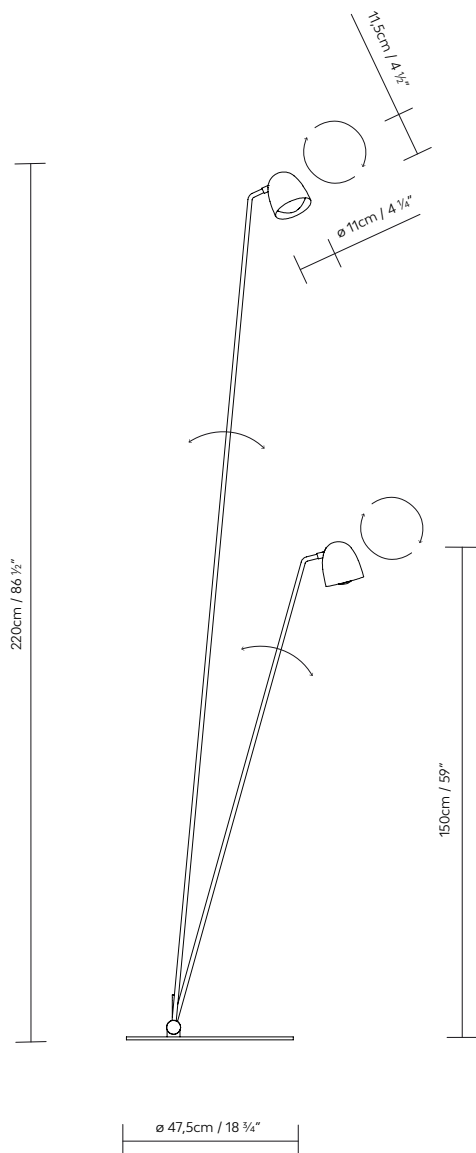

White (matte) / brass (satin)

 Black (matte) / copper (satin)

729206U
729202U

SPEERS F WHITE-BRASS
SPEERS F BLACK-COPPER

LED 2 x 7W 1080lm 2700K CRI \geq 90 110-277V





Table
lamps



B.lux

Bluebird

by
Jorge Pensi

**Decorative
lighting**

Table
lamps

Designed
in 1990

Adjustable table lamp with a metal and wooden structure. Available in two finishes: raw with natural oak, or shiny chrome with matte mahogany.



BLUEBIRD T

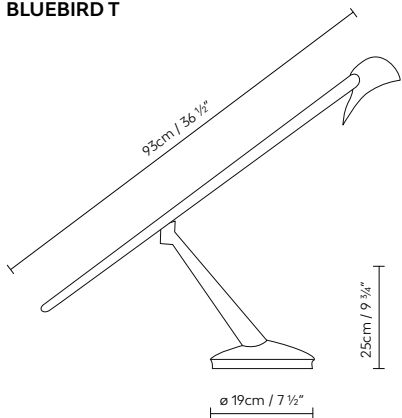

Raw / Natural Oak

 Chrome / Natural Mahogany

602010U **BLUEBIRD T HALO RAW**
 602000U **BLUEBIRD T HALO CHROME** Halo. max. 50W 12V (G6,35)



B.lux

Blux System

**Decorative
lighting**

Table
lamps

Designed
in 1979

Articulated table lamp designed in the late 70s in the style of the English school. The simplicity of its forms is reflected in its friction swivel joints and aluminum shade. Finishes: matte black, matte red or matte beige, and the inside of the shade in satin white. Also available with brass and copper shades that combine with the body of the lamp in black.



BLUX SYSTEM T30

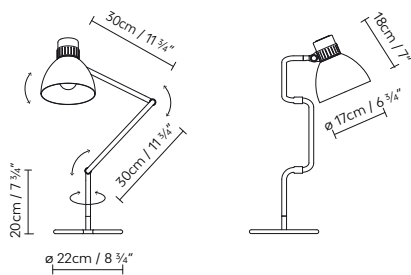

BLUX SYSTEM T40

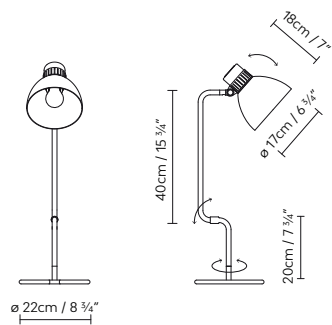

- Black (matte)
- Red (matte)
- Beige (matte)
- Brass (matte) / Black (matte)
- Copper (matte) / Black (matte)

736010U	BLUX SYSTEM T30 BLACK	
736011U	BLUX SYSTEM T30 RED	LED 11W (E26) / Flu.
736012U	BLUX SYSTEM T30 BEIGE	CFL max. 13W (E26) /
736013U	BLUX SYSTEM T30 BRASS	Inc. max. 60W (E26)
736014U	BLUX SYSTEM T30 COPPER	

736020U	BLUX SYSTEM T40 BLACK	
736021U	BLUX SYSTEM T40 RED	LED 11W (E26) / Flu.
736022U	BLUX SYSTEM T40 BEIGE	CFL max. 13W (E26) /
736023U	BLUX SYSTEM T40 BRASS	Inc. max. 60W (E26)
736024U	BLUX SYSTEM T40 COPPER	



B.lux

C_Ball

by
Stone Designs

**Decorative
lighting**

Table
lamps

Decorative table lamp consisting of an opal glass sphere and metal components finished in satin brass or matte black.





C_BALL T

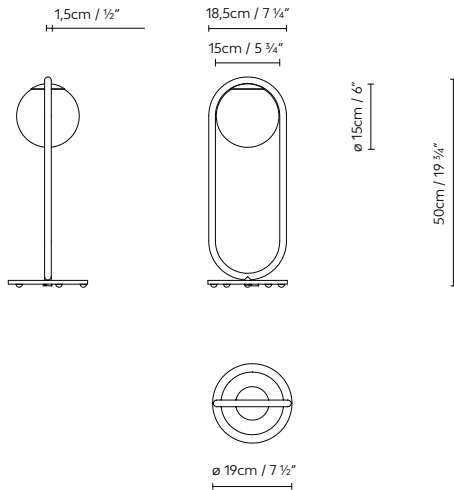

● Brass (satin) ● Black (matte)

748010U
748015U

C_BALL T BRASS
C_BALL T BLACK

LED 6W (E12) / Fluo. CFL max. 12W (E12) / Inc. max. 40W (E12)



C_BALL S p. 44



C_BALL F p. 124



C_BALL W p. 200



C_BALL SYSTEM p. 224

B.lux

Keshi

by
David Abad

Decorative
lighting

Table
lamps

Table lamp crafted of sanded black Markina marble, and a metallic bar shade finished in matte black. Upper metallic reflector with mirror finish. Available in two sizes.





KESHI T50

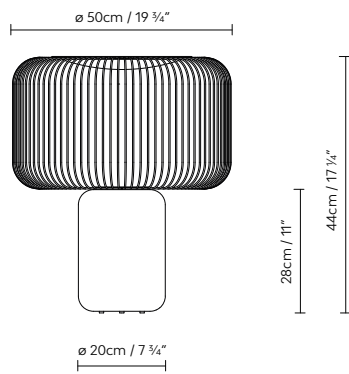

KESHI T30

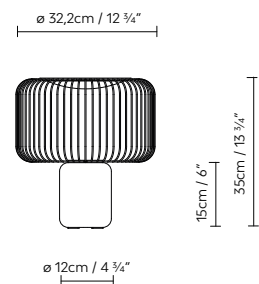

● Black Markina marble (matte)

732051U	KESHI T30	LED 6W (E12)/ Fluo. CFL max. 12W (E12) / Inc. max. 40W (E12)
732050U	KESHI T50	LED 6W (E12)/ Fluo. CFL max. 12W (E12) / Inc. max. 40W (E12)

B.lux

Lola

by
David Abad

Decorative
lighting

Table
lamps

Table lamp with a metal body and fabric shade. It comes in two finishes: black matte textured body with an opaque black shade, or white matte textured body with an opaque white shade. In both versions, the inside of the shade is gold.





LOLAT

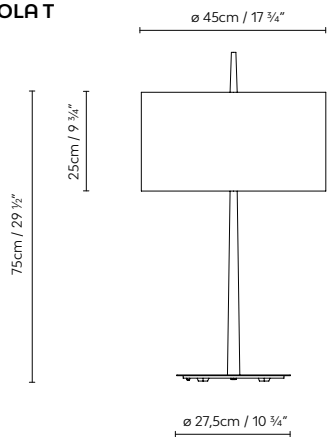

Black / Gold

 White / Gold

702001U	LOLAT BLACK/GOLD	LED 2 x 11W (E26) / Flu. CFL 2 x max. 20W
702002U	LOLAT WHITE/GOLD	(E26) / Inc. 2 x 60W (E26)



B.lux

Misko

by
Stone Designs

**Decorative
lighting**

Table
lamps

Japanese-inspired table lamp, available in three sizes (T15, T25 and T35), all of them created around a disc housing the light source (E26). This disc is available in a walnut or painted matte black finish, which supports the textured blown-glass diffuser that comes in an opal matte white finish.



MISKO T15

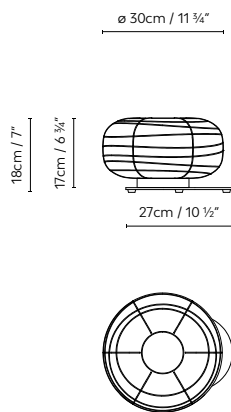

MISKO T25

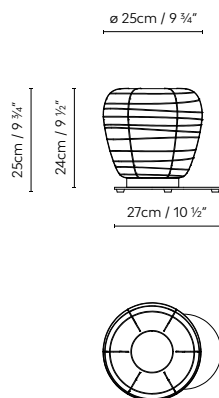

MISKO T35

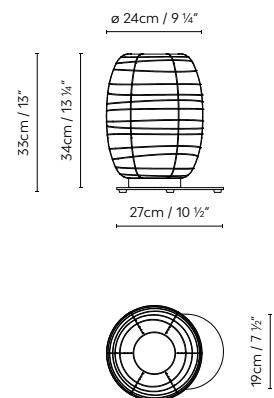

Natural Walnut
 Black (matte)

756003U **MISKO T15** WALNUT
 756004U **MISKO T25** WALNUT
 756008U **MISKO T35** WALNUT

LED 10W (E26) / Flu. CFL max. 11W (E26) / Inc. max 60W (E26)

756005U **MISKO T15** BLACK
 756006U **MISKO T25** BLACK
 756007U **MISKO T35** BLACK

LED 10W (E26) / Flu. CFL max. 11W (E26) / Inc. max 60W (E26)

B.lux

Overlay

by
e27, Tim Brauns

Decorative
lighting

Table
lamps

Blown glass table lamp equipped with three detachable conical reflectors, making it possible to adjust the lighting effect as desired. The glass with a cognac-colored finish, is combined with reflectors in matte beige, copper, grey-beige and yellow. The glass with a grey finish comes with reflectors in beige, dark blue and light blue, all of them matte.



OVERLAY T25

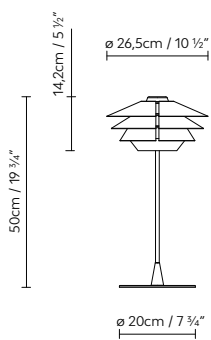

OVERLAY T50

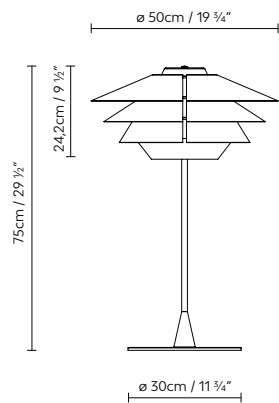

- Cognac glass

 Beige / Copper / Beige (matte)

- Cognac glass

 Yellow / Grey-Beige / Beige (matte)

- Grey glass

 Beige / Beige / Beige (matte)

- Grey glass

 Dark Blue / Light Blue / Beige (matte)

- 734002U **OVERLAY T25** COGNAC GLASS - BEIGE/COPPER/BEIGE
- 734003U **OVERLAY T25** COGNAC GLASS - YELLOW/GREY-BEIGE/BEIGE
- 734004U **OVERLAY T25** GREY GLASS - BEIGE/BEIGE/BEIGE
- 734005U **OVERLAY T25** GREY GLASS - DARK BLUE/LIGHT BLUE/BEIGE

LED 5W (E12) / Fluo. CFL max. 11W (E12) /
Inc. max. 60W (E12)

- 734012U **OVERLAY T50** COGNAC GLASS - BEIGE/COPPER/BEIGE
- 734013U **OVERLAY T50** COGNAC GLASS - YELLOW/GREY-BEIGE/BEIGE
- 734014U **OVERLAY T50** GREY GLASS - BEIGE/BEIGE/BEIGE
- 734015U **OVERLAY T50** GREY GLASS - DARK BLUE/LIGHT BLUE/BEIGE

LED 11W (E26) / Fluo. CFL max. 20W (E26) /
Inc. max. 70W (E26)

B.lux

Petite

by
Miguel Herranz

**Decorative
lighting**

Table
lamps

Articulated, angled table lamp made from extruded aluminum and including a structure and bracket. Available with an aluminum and polycarbonate screen or with a natural white fabric shade. Finishes: matte grey, anodised shiny silver or matte white.





PETITE T21

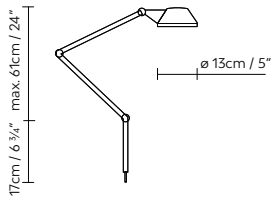

PETITE T22

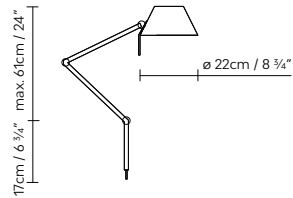

PETITE T11

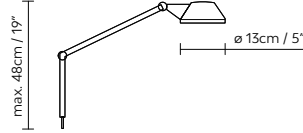

PETITE T12

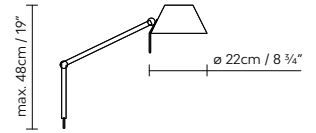

PETITE BRACKET A

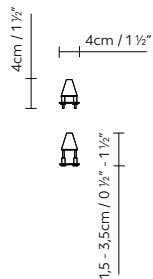

PETITE BRACKET B

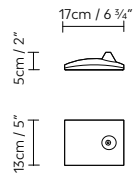

PETITE BRACKET C

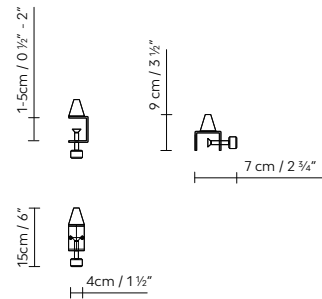

● Grey (matte) ○ White (matte) ● Silver (shiny)

637210U **PETITE 21** GREY + LED 6W (E12) / Fluo.
 637211U **PETITE 21** WHITE + CFL max. 12W (E12) /
 637212U **PETITE 21** SILVER + Inc. max. 40W (E12)

637220U **PETITE 22** GREY + LED 10W (E26) / Fluo.
 637221U **PETITE 22** WHITE + CFL max. 11W (E26) /
 637222U **PETITE 22** SILVER + Inc. max. 60W (E26)

637110U **PETITE 11** GREY + LED 6W (E12) / Fluo.
 637111U **PETITE 11** WHITE + CFL max. 12W (E12) /
 637112U **PETITE 11** SILVER + Inc. max. 40W (E12)

637120U **PETITE 12** GREY + LED 10W (E26) / Fluo.
 637121U **PETITE 12** WHITE + CFL max. 11W (E26) /
 637122U **PETITE 12** SILVER + Inc. max. 60W (E26)

637900U **PETITE BRACKET A** GREY
 637901U **PETITE BRACKET A** WHITE
 637902U **PETITE BRACKET A** SILVER
 637920U **PETITE BRACKET B** GREY
 637921U **PETITE BRACKET B** WHITE
 637922U **PETITE BRACKET B** SILVER
 637940U **PETITE BRACKET C** GREY
 637941U **PETITE BRACKET C** WHITE
 637942U **PETITE BRACKET C** SILVER



B.lux

Regina

by
Jorge Pensi

**Decorative
lighting**

Table
lamps

Designed
in 1987

Indirect light table lamp crafted of die cast aluminum. Available in a raw finish, and also in shiny aluminum, with shades in shiny aluminum or white glass.



REGINAT

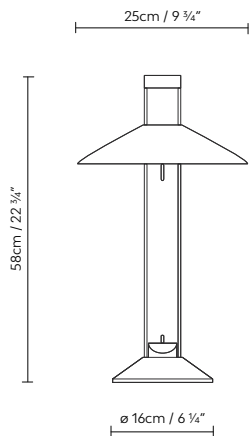

- Raw
- Aluminum (shiny)
- White

625010U	REGINAT HALO RAW	
625000U	REGINAT HALO Aluminum	Halo. 2 x max. 20W 12V (G6,35)
625001U	REGINAT HALO WHITE	



B.lux

Royal

by
David Abad

**Decorative
lighting**

Table
lamps

Table lamp with stainless steel stand and tripod, in a satin finish, with pleated fabric shade. Available in two versions: black shade or beige shade.

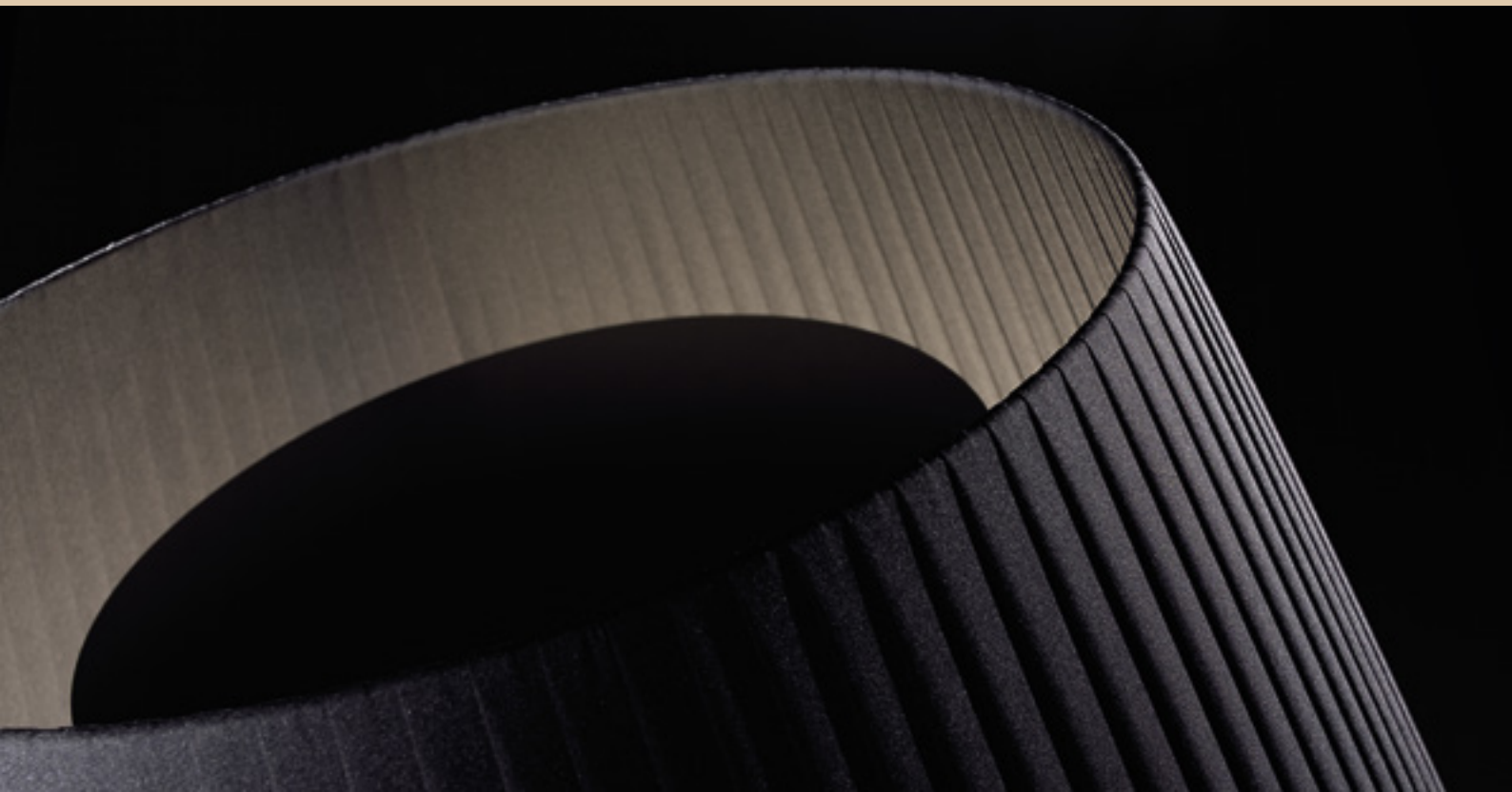



ROYAL T36

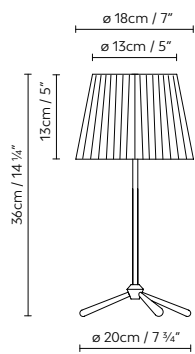

ROYAL T60

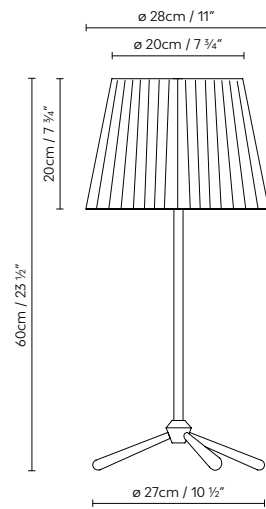

● Black ● Beige

704000U **ROYAL T36 BLACK** LED 5W (E12) / Fluo. CFL max.
 704001U **ROYAL T36 BEIGE** 11W (E12) / Inc. max. 60W (E12)

704010U **ROYAL T60 BLACK** LED 11W (E26) / Fluo. CFL max.
 704011U **ROYAL T60 BEIGE** 23W (E26) / Inc. max. 100W (E26)





Ceiling
lamps



B.lux

Aspen

by
Werner Aisslinger

**Decorative
lighting**

Ceiling
lamps



Direct and diffused light ceiling lamp.

Matte lacquered finishes, with different combinations: grey, snow, lemon, mango, clear turquoise, aqua, merlot, rose, sea, river, limestone, black and brass.

Available in four sizes.



Aspen



ASPEN C17A

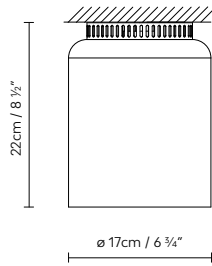

ASPEN C17B

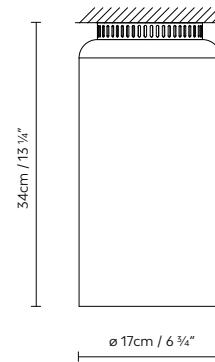

ASPEN C40A

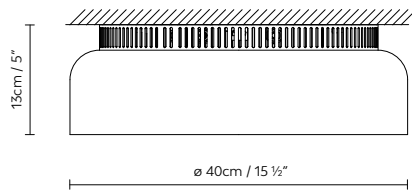

ASPEN C40B

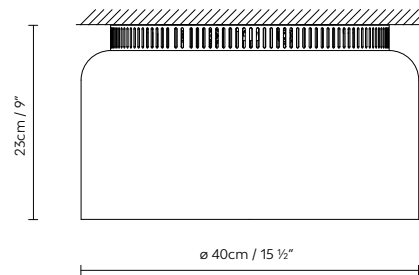

- SHADE:**
- Grey (matte)
 - Mango (matte)
 - Merlot (matte)
 - Rose (matte)
 - Brass (matte)
 - Snow (matte)
 - Clear turquoise (matte)
 - River (matte)
 - Limestone (matte)
 - Lemon (matte)
 - Aqua (matte)
 - Sea (matte)
 - Black (matte)
- RING:**
- Black (matte)

727420U **ASPEN C17A** (E26) LED 15W (E26) / Flu. CFL max. 30W (E26)/ Inc. max. 70W (E26)
 727421U **ASPEN C17B** (E26)

727460U **ASPEN C40A** (E12) LED 2 x 6W (E12) / Flu. CFL 2 x max. 8W (E12) / Inc. 2 x max. 60W (E12)
 727461U **ASPEN C40B** (E12)

B.lux

Blux System

**Decorative
lighting**

Ceiling
lamps

Designed
in 1979

Articulated ceiling lamp designed in the late 70s in the style of the English school. The simplicity of its forms is reflected in its friction swivel joints and aluminum shade. Finishes: matte black, matte red or matte beige, and the inside of the shade in satin white. Also available with brass and copper shades that combine with the body of the lamp in black.



BLUX SYSTEM C

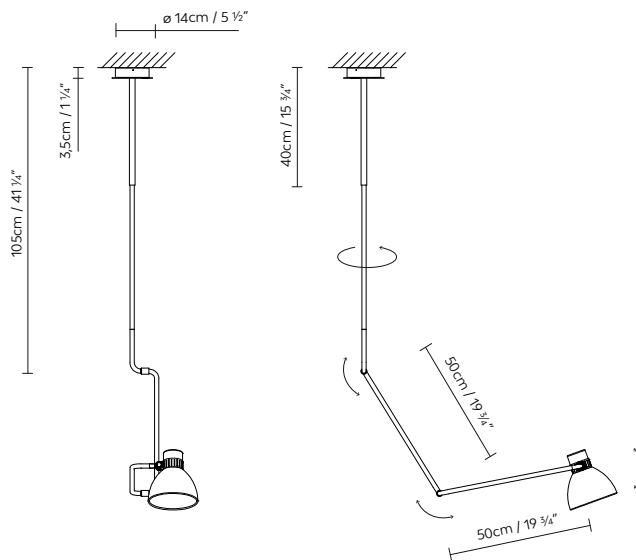

Black (matte)
 Red (matte)
 Beige (matte)
 Brass (matte) / Black (matte)
 Copper (matte) / Black (matte)

736400U **BLUX SYSTEM C BLACK**
 736401U **BLUX SYSTEM C RED**
 736402U **BLUX SYSTEM C BEIGE**
 736403U **BLUX SYSTEM C BRASS**
 736404U **BLUX SYSTEM C COPPER**

LED 11W (E26) / Fluo. CFL max. 13W (E26) / Inc. max. 60W (E26)



BLUX SYSTEM F p. 120



BLUX SYSTEM T p. 140



BLUX SYSTEM W p. 194

B.lux

Castle

by
Stone Designs

**Decorative
lighting**

Ceiling
lamps

Round aluminum LED ceiling lamp with a highly uniform opal white PMMA diffuser.

Finishes: textured matte white, textured matte black and natural oak. Direct light with a soft indirect light effect. Available in three sizes. Dimmer.





CASTLE C60

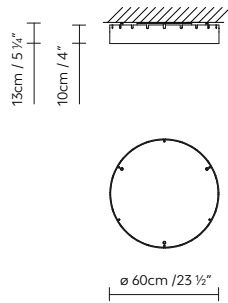

CASTLE C90

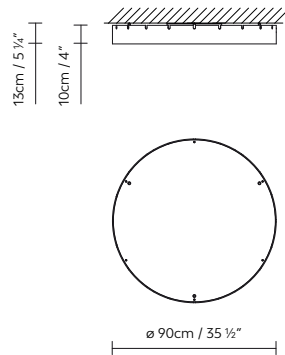

CASTLE C120

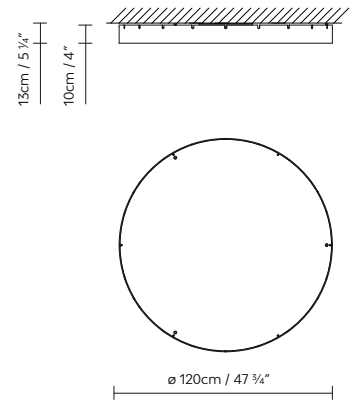

○ White (matte) ● Black (matte) ● Natural Oak

737411U	CASTLE C60 WHITE	LED 17,4W 3416lm 150mA 3000K CRI≥90 110-277V DIM 1-10V
737412U	CASTLE C60 BLACK	
737413U	CASTLE C60 OAK	
737431U	CASTLE C90 WHITE	LED 41W 7960lm 350mA 3000K CRI≥90 110-277V DIM 1-10V
737432U	CASTLE C90 BLACK	
737433U	CASTLE C90 OAK	
737451U	CASTLE C120 WHITE	LED 19,5W 3664lm 225mA + LED 41W 7960lm 350mA 3000K CRI≥90 110-277V DIM 1-10V
737452U	CASTLE C120 BLACK	
737453U	CASTLE C120 OAK	

B.lux

Lite Hole

by
David Abad

Decorative
lighting

Ceiling
lamps

Large ceiling and wall lamp consisting of two concentric aluminum hoops that make up a short, circular lighting body. It is manufactured in two large sizes, with diameters of 120 and 90 centimeters, as well as in a 60-cm size. They all feature an acrylic opal diffuser that hides a direct-emitting and dimmable LED light source that is completely glare-free. Lite Hole is available in matte white, matte black, copper and gold.



Lite Hole





LITE HOLE C/W 60

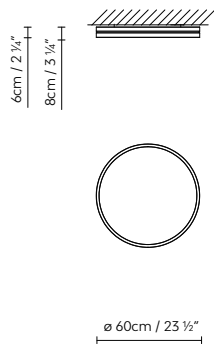

LITE HOLE C/W 90

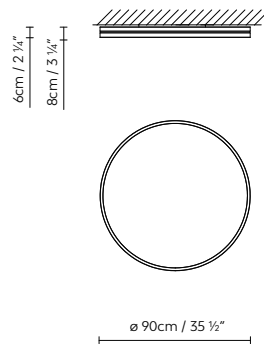

LITE HOLE C/W 120

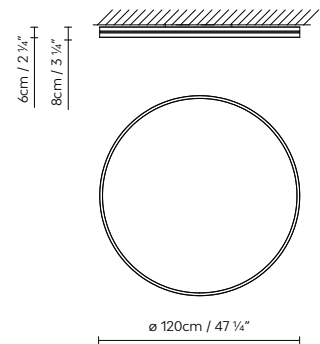

○ White (matte) ● Black (matte) ● Gold ● Copper

755411U	LITE HOLE C/W 60 WHITE	LED 17,4W 3416lm 150mA 3000K CRI≥90 110-277V DIM 1-10V
755412U	LITE HOLE C/W 60 BLACK	
755413U	LITE HOLE C/W 60 GOLD	
755414U	LITE HOLE C/W 60 COPPER	
755431U	LITE HOLE C/W 90 WHITE	LED 41W 7960lm 350mA 3000K CRI≥90 110-277V DIM 1-10V
755432U	LITE HOLE C/W 90 BLACK	
755433U	LITE HOLE C/W 90 GOLD	
755434U	LITE HOLE C/W 90 COPPER	
755451U	LITE HOLE C/W 120 WHITE	LED 19,5W 3664lm 225mA + LED 41W 7960lm 350mA 3000K CRI≥90 110-277V DIM 1-10V
755452U	LITE HOLE C/W 120 BLACK	
755453U	LITE HOLE C/W 120 GOLD	
755454U	LITE HOLE C/W 120 COPPER	

B.lux

Lite Square

by
David Abad

**Decorative
lighting**

Ceiling
lamps

Ceiling and wall lamp with diffused and adjustable LED light. Lite Square features two concentric metal profiles that stand out for their tiny size, only 6 cm thick. Made in two square sizes, of 60x60 cm or 110x110 cm, and in a rectangular size of 110x60 cm. They are all available in matte white, matte black, copper and gold. They all have an opal acrylic diffuser.





LITE SQUARE C/W 60x60

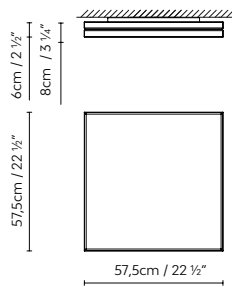

LITE SQUARE C/W 110x60

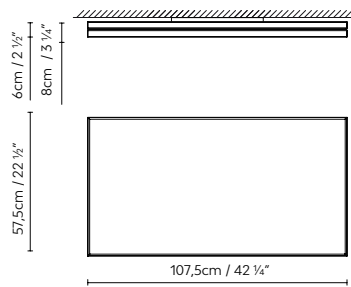

LITE SQUARE C/W 110x110

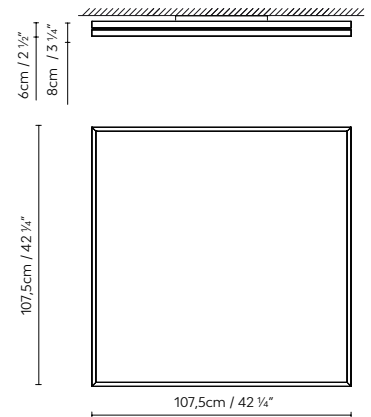

○ White (matte) ● Black (matte) ● Gold ● Copper

754411U	LITE SQUARE C/W 60x60 WHITE	LED 28,8W 5360lm 350mA 3000K CRI≥90 110-277V DIM 1-10V
754412U	LITE SQUARE C/W 60x60 BLACK	
754413U	LITE SQUARE C/W 60x60 GOLD	
754414U	LITE SQUARE C/W 60x60 COPPER	
754431U	LITE SQUARE C/W 110x60 WHITE	LED 57,6W 10720lm 350mA 3000K CRI≥90 110-277V DIM 1-10V
754432U	LITE SQUARE C/W 110x60 BLACK	
754433U	LITE SQUARE C/W 110x60 GOLD	
754434U	LITE SQUARE C/W 110x60 COPPER	
754451U	LITE SQUARE C/W 110x110 WHITE	LED 115,2W 21440lm 350mA 3000K CRI≥90 110-277V DIM 1-10V
754452U	LITE SQUARE C/W 110x110 BLACK	
754453U	LITE SQUARE C/W 110x110 GOLD	
754454U	LITE SQUARE C/W 110x110 COPPER	

B.lux

Misko

by
Stone Designs

**Decorative
lighting**

Ceiling
lamps

Japanese-style ceiling lamp, available in three sizes (C/W15, C25 and C35). Made with a disc that holds a source of light (E26). This disc can come in natural walnut or painted in matte black and supports the textured blow-glass diffuser with an opal matte white finish.



MISKO C/W15

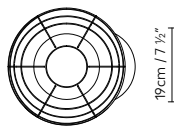
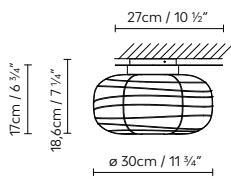

MISKO C25

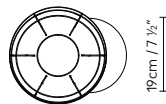
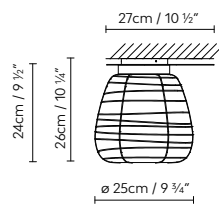

MISKO C35

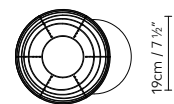
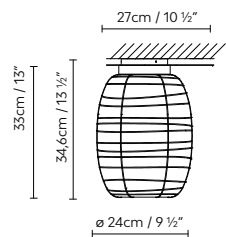

● Natural Walnut ● Black (matte)

756403U	MISKO C/W15 WALNUT	LED 10W (E26) /
756404U	MISKO C25 WALNUT	Fluo. CFL max. 11W (E26) /
756408U	MISKO C35 WALNUT	Inc. max 60W (E26)

756405U	MISKO C/W15 BLACK	LED 10W (E26) /
756406U	MISKO C25 BLACK	Fluo. CFL max. 11W (E26) /
756407U	MISKO C35 BLACK	Inc. max 60W (E26)



B.lux

Q. Bo

by
Carlos Serra

**Decorative
lighting**

Ceiling
lamps

Wall or ceiling lamp with an opal white polycarbonate diffuser and aluminum base painted in matte white.



Q.BO C/W

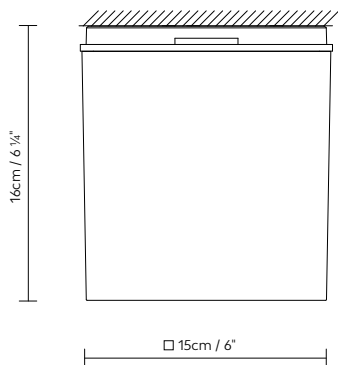

White (matte)

820105EU

Q.BO C/W FLUO WHITE

Fluo. 18W (GX24 q-2)



CE EAC



B.lux

Quadrat

by
Jorge Pensi

**Decorative
lighting**

Ceiling
lamps

Square ceiling lamp, made from oak laminate.

Available in three finishes: natural oak, wenge and matte white. Lower shade made from heat-shrunk film, and upper shade from polycarbonate.



QUADRAT C60x60

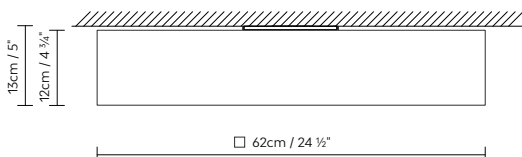

- Natural Oak
- Wenge
- White (matte)

661400U	QUADRAT C60x60 FLUO OAK	Fluo. 4 x 14W (G5) /
661405U	QUADRAT C60x60 FLUO WENGE	LED 4 x 7W (G5)
661401U	QUADRAT C60x60 FLUO WHITE	

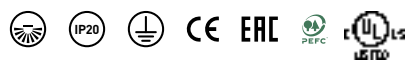

B.lux

R2

by
David Abad

**Decorative
lighting**

Ceiling
lamps

Aluminum ceiling lamp shaped like a circular ring. For its light source, it uses LED floodlight modules that provide uniform lighting. Finishes: matte white, matte bronze, matte black, natural oak wood or walnut. Available in three sizes. Dimmer.



R2 C60

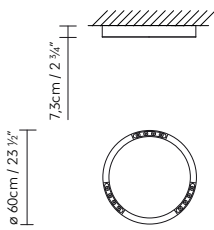

R2 C90

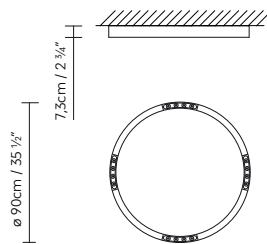

R2 C120

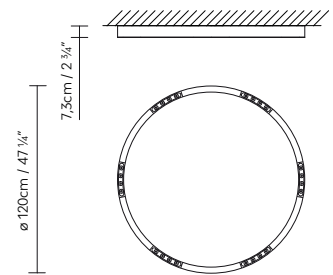

- White (matte)
 Bronze (matte)
 Black (matte)
 Natural Oak
 Natural Walnut

743410U	R2 C60 WHITE	
743411U	R2 C60 BRONZE	
743412U	R2 C60 BLACK	LED 3 x 18W 7879lm 250mA 3000K CRI≥90 110-277V DIM PUSH/1-10V
743413U	R2 C60 OAK	
743414U	R2 C60 WALNUT	

743420U	R2 C90 WHITE	
743421U	R2 C90 BRONZE	
743422U	R2 C90 BLACK	LED 4 x 18W 9755lm 250mA 3000K CRI≥90 110-277V DIM PUSH/1-10V
743423U	R2 C90 OAK	
743424U	R2 C90 WALNUT	

743430U	R2 C120 WHITE	
743431U	R2 C120 BRONZE	
743432U	R2 C120 BLACK	LED 6 x 18W 13957lm 240mA 3000K CRI≥90 110-277V DIM PUSH/1-10V
743433U	R2 C120 OAK	
743434U	R2 C120 WALNUT	

B.lux

Roof

by
David Abad

**Decorative
lighting**

Ceiling
lamps

Wall or ceiling lamp (C/W), both individual (I) or double (II). All made of aluminum, with a transparent glass diffuser and diffuse light. Available in anodised satin silver or matte white finishes.





ROOF C/W I

ROOF C/W I 70: 710mm / 28"
 ROOF C/W I 130: 1310mm / 51 1/2"
 ROOF C/W I 160: 1610mm / 63 1/2"

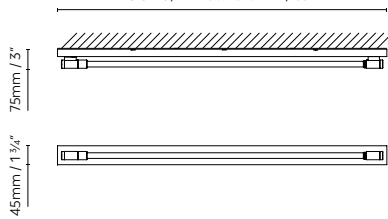

ROOF C/W II

ROOF C/W II 70: 710mm / 28"
 ROOF C/W II 130: 1310mm / 51 1/2"
 ROOF C/W II 160: 1610mm / 63 1/2"

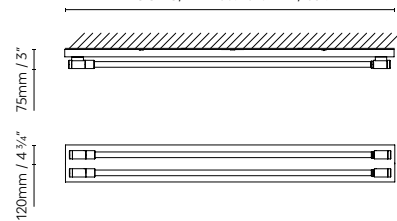

ROOF C/W: ● Silver (satin) ○ White (matte)

847100U	ROOF C/W I 70 SILVER	Fluo. 14W (G5) / LED 7W (G5)
847101U	ROOF C/W I 70 WHITE	Fluo. 14W (G5) / LED 7W (G5)
847110U	ROOF C/W I 130 SILVER	Fluo. 28W (G5) / LED 17W (G5)
847111U	ROOF C/W I 130 WHITE	Fluo. 28W (G5) / LED 17W (G5)
847120U	ROOF C/W I 160 SILVER	Fluo. 35W (G5) / LED 18W (G5)
847121U	ROOF C/W I 160 WHITE	Fluo. 35W (G5) / LED 18W (G5)

847150U	ROOF C/W II 70 SILVER	Fluo. 14W (G5) / LED 7W (G5)
847151U	ROOF C/W II 70 WHITE	Fluo. 14W (G5) / LED 7W (G5)
847160U	ROOF C/W II 130 SILVER	Fluo. 28W (G5) / LED 17W (G5)
847161U	ROOF C/W II 130 WHITE	Fluo. 28W (G5) / LED 17W (G5)
847170U	ROOF C/W II 160 SILVER	Fluo. 35W (G5) / LED 18W (G5)
847171U	ROOF C/W II 160 WHITE	Fluo. 35W (G5) / LED 18W (G5)

B.lux

Speers Arm

by
David Abad

**Decorative
lighting**

Ceiling
lamps

Ceiling lamp with two metal arms that come in textured matte black or white. These arms are combined with two sizes of articulated shades: L and S. The L shade is made in aluminum and available in solid textured matte white or black. The S shade is made in satin brass with a textured matte white finish on the outside, or in satin copper with a textured matte black finish on the outside. The Speers Arm C lamp is equipped with a high-luminance LED light source. It includes a glass lens that focuses the light and enhances its luminous efficiency.





SPEERS ARM C BODY + SHADE S

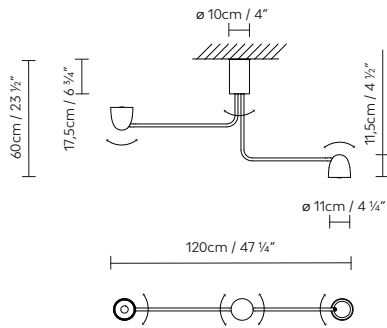

SPEERS ARM C BODY + SHADE L

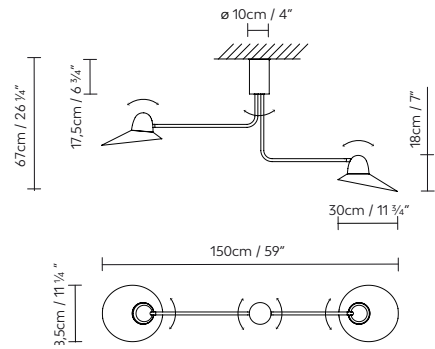

SHADE S: ○ ● White (matte) / Brass (satin) ● ● Black (matte) / Copper (satin)

SHADE L: ○ White ● Black

BODY: ○ White ● Black

757101U **SPEERS ARM SHADE S WHITE / BRASS +**
 757102U **SPEERS ARM SHADE S BLACK / COPPER +**
 757106U **SPEERS ARM SHADE L WHITE+**
 757107U **SPEERS ARM SHADE L BLACK+**

LED 9W 1100lm 500mA 2700K CRI≥90 110-277V

757421U **SPEERS ARM C BODY WHITE+**
 757422U **SPEERS ARM C BODY BLACK+**



B.lux

Tree Series

by
Werner Aisslinger

**Decorative
lighting**

Ceiling
lamps

Ceiling lamp with an organic look and aluminum shade. Direct and reflected light. Available in textured monochromatic white or black matte finishes, and textured two-toned matte black and white, with a gold interior.



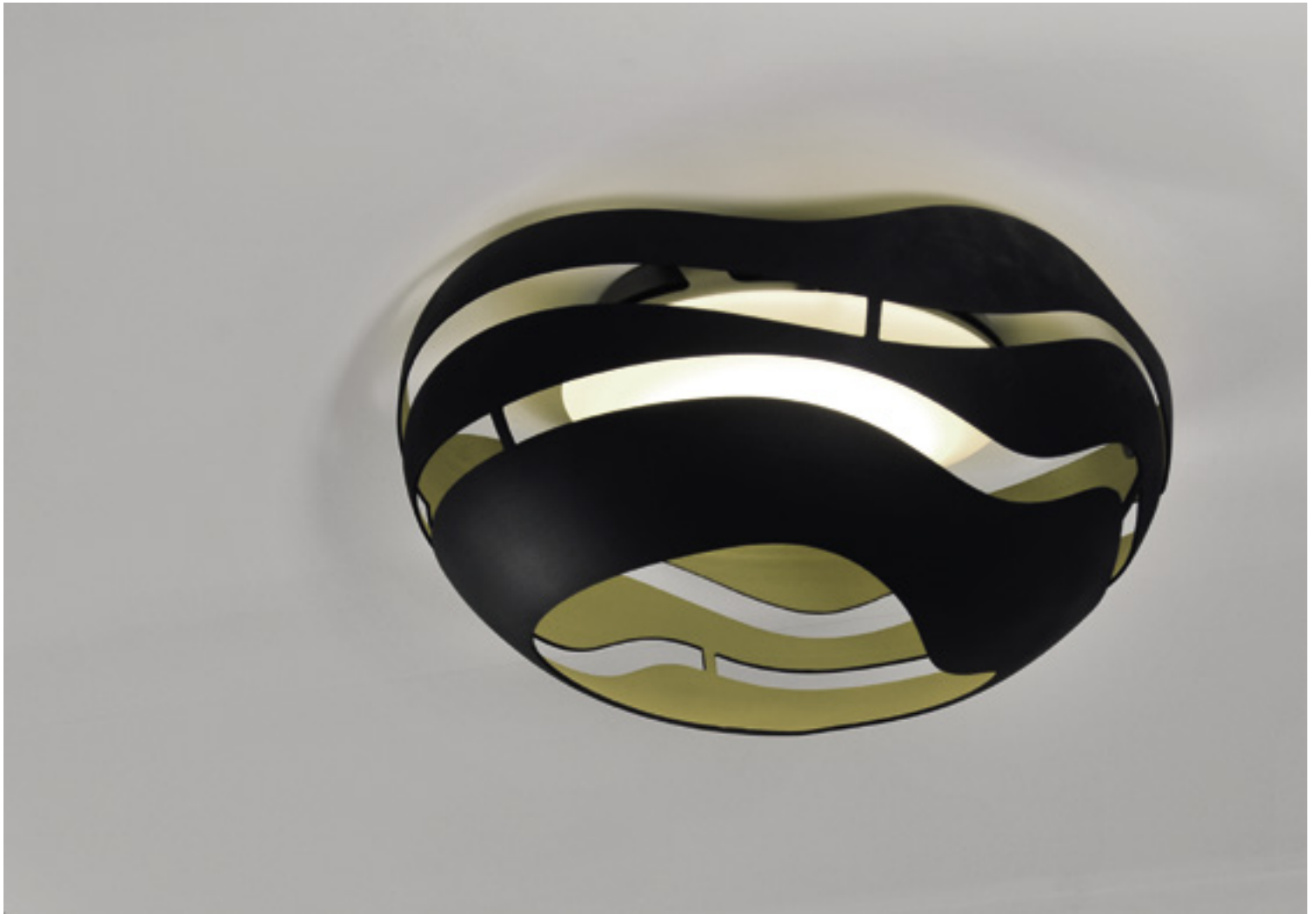

TREE SERIES C50

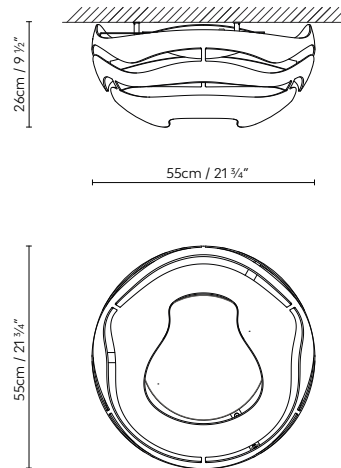

- | | |
|-----------------------------------|----------------------------------|
| ○ ○ White (matte) / white (matte) | ○ ● White (matte) / gold (matte) |
| ● ● Black (matte) / black (matte) | ● ● Black (matte) / gold (matte) |

- | | |
|---------|------------------------------------|
| 701432U | TREE SERIES C50 WHITE-WHITE |
| 701433U | TREE SERIES C50 BLACK-BLACK |
| 701434U | TREE SERIES C50 WHITE-GOLD |
| 701435U | TREE SERIES C50 BLACK-GOLD |

LED 2 x 11W (E12) / Flu. CFL 2 x 23W (E12) / Inc. 2 x 60W (E12)

B.lux

Veroca

by
Miguel Ángel Ciganda

**Decorative
lighting**

Ceiling
lamps

Ceiling lamp featuring a non-flammable textile diffuser, light-up body and four tension springs, with their respective supports. The textile diffuser can be machine washed and ironed without losing its features. The combination of various textile diffusers allows for multiple arrangements. Available in white or natural white. The Veroca comes in four sizes, all available with fluorescent bulbs or LED.



Veroca



VEROCA 1

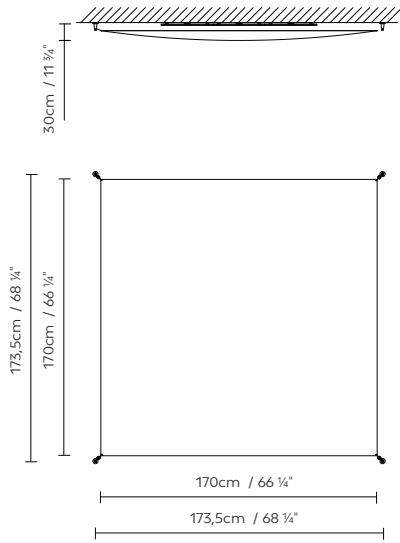

VEROCA 2

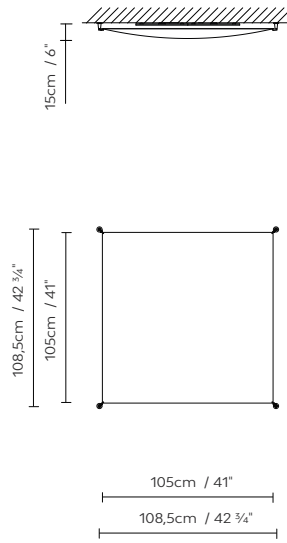

VEROCA 3

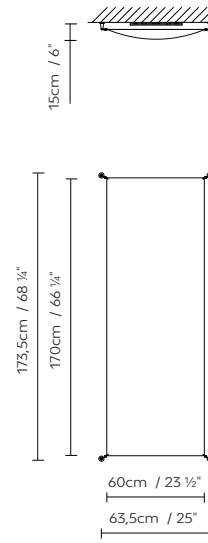

VEROCA 4

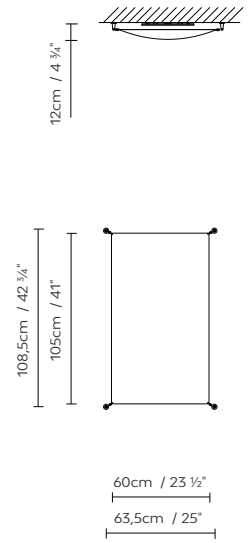

○ White ● Natural white

818415U	VEROCA 1 ELECTRONIC (G5) BODY +	Fluo. 6 x 28W (G5) / LED 6 x 17W (G5)
818416DU	VEROCA 1 LED DIM PUSH-DALI BODY +	LED 6 x 21W 21216lm 450mA 3000K CRI≥90 120-277V DIM 0-10V
818411U	VEROCA 1 SHADE WHITE	
818412U	VEROCA 1 SHADE NATURAL WHITE	
818425U	VEROCA 2 ELECTRONIC (G5) BODY +	Fluo. 4 x 14W (G5) / LED 4 x 7W (G5)
818426DU	VEROCA 2 LED DIM PUSH-DALI BODY +	LED 4 x 10,5W 7072lm 450mA 3000K CRI≥90 120-277V DIM 0-10V
818421U	VEROCA 2 SHADE WHITE	
818422U	VEROCA 2 SHADE NATURAL WHITE	
818435U	VEROCA 3 ELECTRONIC (G5) BODY +	Fluo. 2 x 28W (G5) / LED 2 x 17W (G5)
818436DU	VEROCA 3 LED DIM PUSH-DALI BODY +	LED 2 x 21W 7072lm 450mA 3000K CRI≥90 120-277V DIM 0-10V
818431U	VEROCA 3 SHADE WHITE	
818432U	VEROCA 3 SHADE NATURAL WHITE	
818445U	VEROCA 4 ELECTRONIC (G5) BODY +	Fluo. 2 x 14W (G5) / LED 2 x 7W (G5)
818446DU	VEROCA 4 LED DIM PUSH-DALI BODY +	LED 2 x 10,5W 3536lm 450mA 3000K CRI≥90 120-277V DIM 0-10V
818441U	VEROCA 4 SHADE WHITE	
818442U	VEROCA 4 SHADE NATURAL WHITE	



Wall
lamps



B.lux

Blux System

**Decorative
lighting**

Wall
lamps

Designed
in 1979

Articulated wall lamp designed in the late 70s in the style of the English school. The simplicity of its forms is reflected in its friction swivel joints and aluminum shade. Finishes: matte black, matte red or matte beige, and the inside of the shade in satin white. Also available with brass and copper shades that combine with the body of the lamp in black.



Blux System



BLUX SYSTEM W20

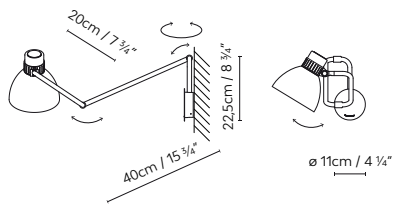

BLUX SYSTEM W20 PLUG-IN

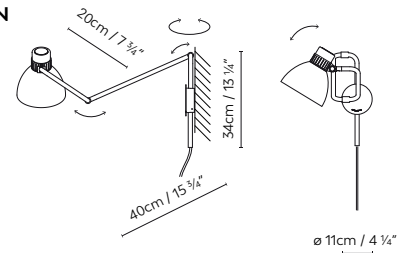

BLUX SYSTEM W40

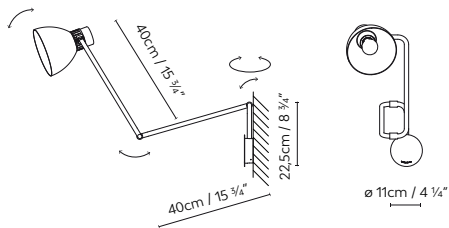

BLUX SYSTEM W40 PLUG-IN

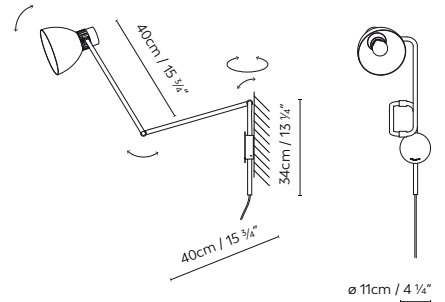

BLUX SYSTEM W125

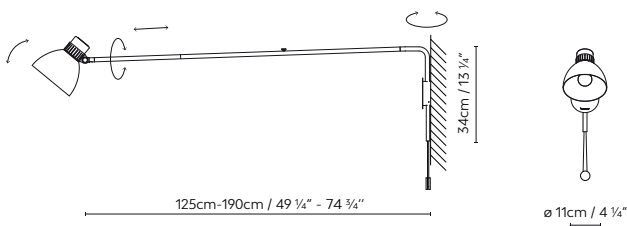

BLUX SYSTEM W125 PLUG-IN

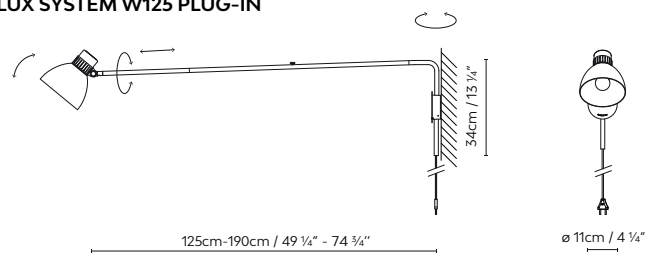



BLUX SYSTEM W

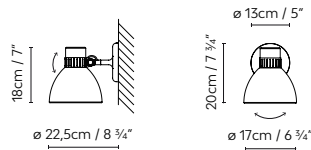

Black (matte)
 Red (matte)
 Beige (matte)
 Brass (matte) / Black (matte)
 Copper (matte) / Black (matte)

736170U	BLUX SYSTEM W BLACK	
736171U	BLUX SYSTEM W RED	LED 11W (E26) / Fluo. CFL max. 13W
736172U	BLUX SYSTEM W BEIGE	(E26) / Inc. max. 60W (E26)
736173U	BLUX SYSTEM W BRASS	
736174U	BLUX SYSTEM W COPPER	
736100U	BLUX SYSTEM W20 BLACK	
736101U	BLUX SYSTEM W20 RED	LED 11W (E26) / Fluo. CFL max. 13W
736102U	BLUX SYSTEM W20 BEIGE	(E26) / Inc. max. 60W (E26)
736103U	BLUX SYSTEM W20 BRASS	
736104U	BLUX SYSTEM W20 COPPER	
736105U	BLUX SYSTEM W20 PLUG-IN BLACK	
736106U	BLUX SYSTEM W20 PLUG-IN RED	LED 11W (E26) / Fluo. CFL max. 13W
736107U	BLUX SYSTEM W20 PLUG-IN BEIGE	(E26) / Inc. max. 60W (E26)
736108U	BLUX SYSTEM W20 PLUG-IN BRASS	
736109U	BLUX SYSTEM W20 PLUG-IN COPPER	

736120U	BLUX SYSTEM W40 BLACK	
736121U	BLUX SYSTEM W40 RED	LED 11W (E26) / Fluo. CFL max. 13W
736122U	BLUX SYSTEM W40 BEIGE	(E26) / Inc. max. 60W (E26)
736123U	BLUX SYSTEM W40 BRASS	
736124U	BLUX SYSTEM W40 COPPER	
736125U	BLUX SYSTEM W40 PLUG-IN BLACK	
736126U	BLUX SYSTEM W40 PLUG-IN RED	LED 11W (E26) / Fluo. CFL max. 13W
736127U	BLUX SYSTEM W40 PLUG-IN BEIGE	(E26) / Inc. max. 60W (E26)
736128U	BLUX SYSTEM W40 PLUG-IN BRASS	
736129U	BLUX SYSTEM W40 PLUG-IN COPPER	
736150U	BLUX SYSTEM W125 BLACK	
736151U	BLUX SYSTEM W125 RED	LED 11W (E26) / Fluo. CFL max. 13W
736152U	BLUX SYSTEM W125 BEIGE	(E26) / Inc. max. 60W (E26)
736153U	BLUX SYSTEM W125 BRASS	
736154U	BLUX SYSTEM W125 COPPER	
736155U	BLUX SYSTEM W125 PLUG-IN BLACK	
736156U	BLUX SYSTEM W125 PLUG-IN RED	LED 11W (E26) / Fluo. CFL max. 13W
736157U	BLUX SYSTEM W125 PLUG-IN BEIGE	(E26) / Inc. max. 60W (E26)
736158U	BLUX SYSTEM W125 PLUG-IN BRASS	
736159U	BLUX SYSTEM W125 PLUG-IN COPPER	

B.lux

Bowee

by
Werner Aisslinger

**Decorative
lighting**

Wall
lamps

LED wall lamp made with half-sphere shades. Available with either one shade (W1 left and W1 right), both with a switch, or two shades (W2). On all these lamps, the light source can be adjusted on its horizontal axis and gives direct and diffused light. Available in metallic English bronze, matte turquoise and matte beige.



BOWEE W1 LEFT

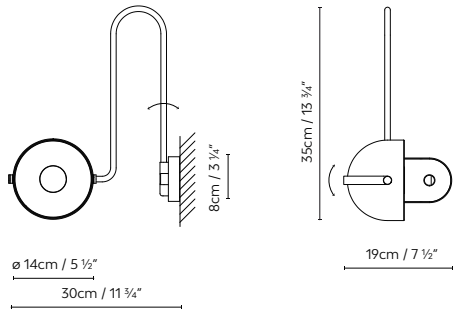

BOWEE W1 RIGHT

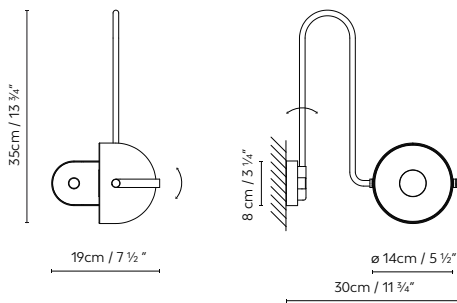

BOWEE W2

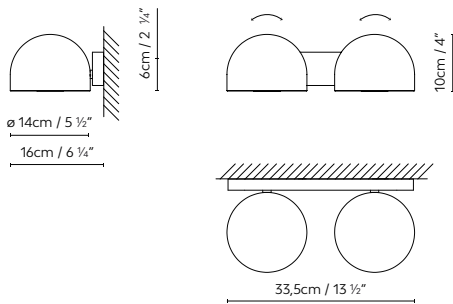

● Beige (matte) ● Clear turquoise (matte) ● Metallic English bronze

758100U **BOWEE W1 LEFT** BEIGE
 758101U **BOWEE W1 LEFT** CLEAR TURQUOISE
 758102U **BOWEE W1 LEFT** METALLIC ENGLISH BRONZE

LED 6,4W 760lm 350mA 3000K CRI≥90

758110U **BOWEE W1 RIGHT** BEIGE
 758111U **BOWEE W1 RIGHT** CLEAR TURQUOISE
 758112U **BOWEE W1 RIGHT** METALLIC ENGLISH BRONZE

LED 6,4W 760lm 350mA 3000K CRI≥90

758120U **BOWEE W2** BEIGE
 758121U **BOWEE W2** CLEAR TURQUOISE
 758122U **BOWEE W2** METALLIC ENGLISH BRONZE

LED 2 x 6,4W 1520lm 350mA 3000K CRI≥90

B.lux

C_Ball

by
Stone Designs

**Decorative
lighting**

Wall
lamps

Decorative wall lamp consisting of an opal glass sphere and metal components finished in satin brass or matte black. Available in two versions: diffused light (1L), or diffused light and adjustable beam for reading (2L).





C_BALL W (1L)

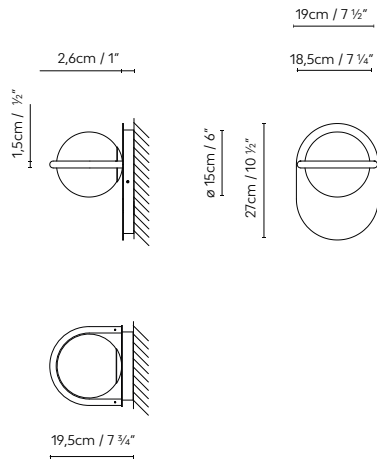

C_BALL W (2L)

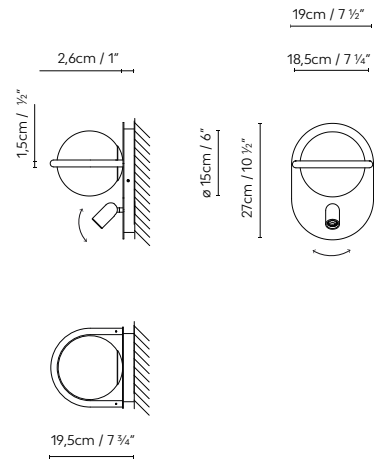

● Brass (satin) ● Black (matte)

748410U **C_BALL W (1L) BRASS** LED 6W (E12) / Fluo. CFL max. 12W (E12) / Inc. max. 40W (E12)
 748415U **C_BALL W (1L) BLACK**

748420U **C_BALL W (2L) BRASS** LED 6W (E12) / Fluo. CFL max. 12W (E12) / Inc. max. 40W (E12)
 748425U **C_BALL W (2L) BLACK** + LED 4,5W 546lm 250mA 3000K CRI≥90 120V



C_BALL S p. 44



C_BALL F p. 124



C_BALL T p. 142



C_BALL SYSTEM p. 224

B.lux

Cone Light

by
Werner Aisslinger

Decorative
lighting

Wall
lamps

Vitrified translucent porcelain wall lamp.

Available in texturized matte white,
with brass fittings. A soft glow around
it, and direct light below.



CONE LIGHT W

○ ● White (matte) / Brass

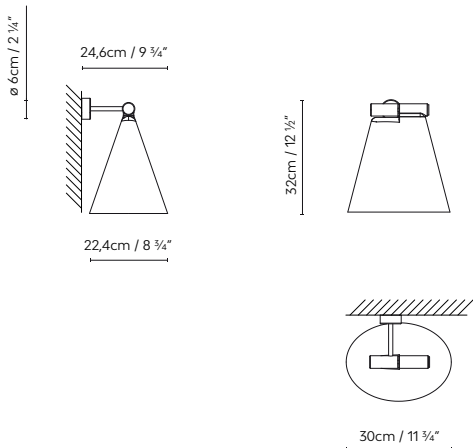

739112U **CONE LIGHT W BRASS** LED 15W (E26) / Flu. CFL max. 30W (E26) / Inc. max. 100W (E26)

B.lux

Dolce

by
Miguel Ángel Ciganda

**Decorative
lighting**

Wall
lamps

Wall lamps with natural white fabric shade. Available in three sizes.



DOLCE W1

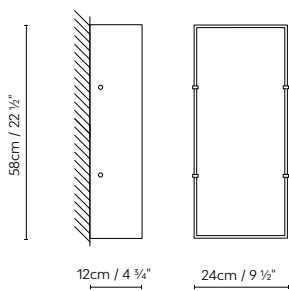

DOLCE W2

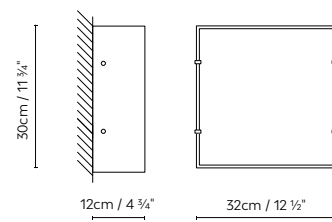

DOLCE W3

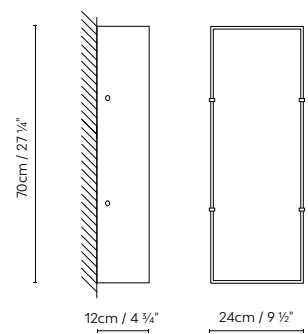

● Natural white

821101EU	DOLCE W1 FLUO	Fluo. 36W (2G11)
821102EU	DOLCE W2 FLUO	Fluo. 2 x 18W (2G11)
821103EU	DOLCE W3 FLUO	Fluo. 3 x 18W (G13)



B.lux

Misko

by
Stone Designs

**Decorative
lighting**

Wall
lamps

Japanese-style wall lamp. Made with a disc that holds a source of light (E26). This disc can come in natural walnut or painted in matte black and supports the textured blow-glass diffuser with an opal matte white finish.





MISKO C/W15

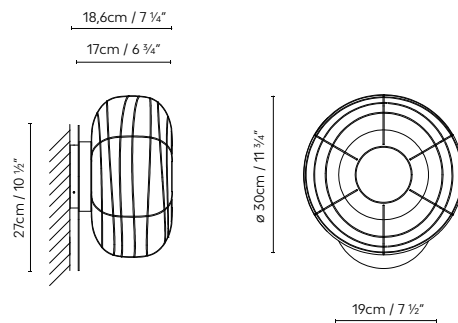

● Natural Walnut ● Black (matte)

756403U **MISKO C/W15 WALNUT**
 756405U **MISKO C/W15 BLACK**

LED 10W (E26) / Flu. CFL max. 11W (E26)



MISKO S p. 76

MISKO F p. 128

MISKO T p. 148

MISKO C p. 174

B.lux

Nora

**Decorative
lighting**

Wall
lamps

Surface wall lamp, made out of stainless steel satin finish and a polycarbonate diffuser. Multiple pictograms may be incorporated.





NORA SURFACE

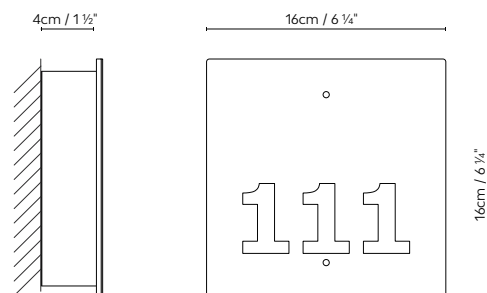

● Stainless steel (satin)

829100U

NORA SURFACE

Fluo. max. 5W (2G7)



B.lux

Q. Bo

by
Carlos Serra

**Decorative
lighting**

Wall
lamps

Wall or ceiling lamp with an opal white polycarbonate diffuser and aluminum base painted in matte white.



Q.BO C/W

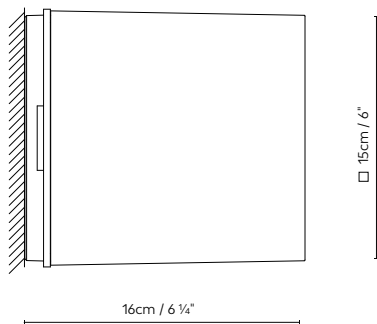

White (matte)

820105EU **Q.BO C/W** FLUO WHITE Fluo. 18W (GX24 q-2)



B.lux

Speers

by
David Abad

Decorative
lighting

Wall
lamps

Wall lamp with an adjustable direct light. The light source is a high-luminance LED, which features a glass lens to focus the light and improve performance. Available in two finishes: textured white matte outer finish with a satin brass interior, and textured black matte exterior with satin copper interior.





SPEERS W (1L)

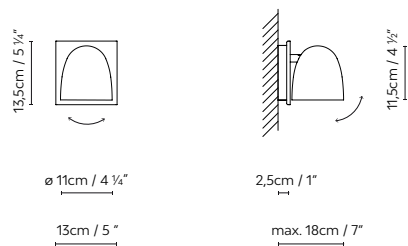

- White (matte) / brass (satin)

 Black (matte) / copper (satin)

729116U
729112U

SPEERS W (1L) WHITE-BRASS
SPEERS W (1L) BLACK-COPPER

LED 9W 1100lm 500mA 2700K CRI≥90 100-250V



B.lux

Speers Arm

by
David Abad

**Decorative
lighting**

Wall
lamps

Wall lamp available in two models: the individual one has one arm (W1) and the double one has two arms (W2). The arms are made in metal and have a textured black or white finish. These arms are combined with two sizes of articulated shades: L and S. The L shade is made in aluminum and available in solid textured matte white or black. The S shade is made in satin brass with a textured matte white finish on the outside, or in satin copper with a textured matte black finish on the outside. The Speers Arm W lamp is equipped with a high-luminance LED light source. It includes a glass lens that focuses the light and enhances its luminous efficiency.



Speers Arm





SPEERS ARM W BODY 2 + SHADE S

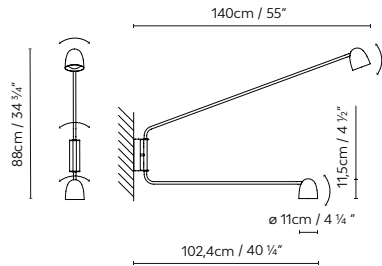

SPEERS ARM W BODY 2 + SHADE L

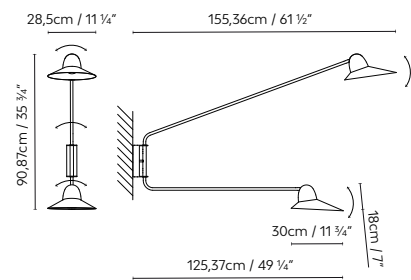

SPEERS ARM W BODY 1 + SHADE S

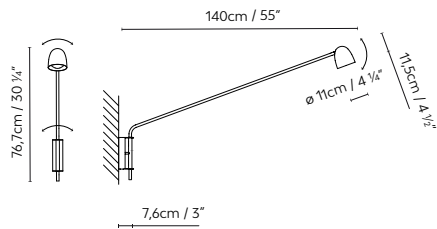

SPEERS ARM W BODY 1 + SHADE L

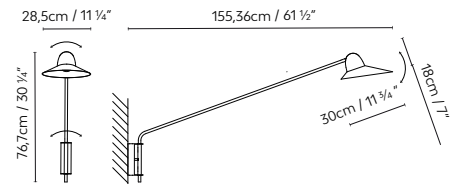

SHADE S: ○ ● White (matte) / Brass (satin) ● ● Black (matte) / Copper (satin)

SHADE L: ○ White ● Black

BODY: ○ White ● Black

757101U **SPEERS ARM SHADE S WHITE / BRASS +**
 757102U **SPEERS ARM SHADE S BLACK / COPPER +**
 757106U **SPEERS ARM SHADE L WHITE+**
 757107U **SPEERS ARM SHADE L BLACK+**

LED 9W 1100lm 500mA 2700K CRI≥90 110-277V

757111U **SPEERS ARM W BODY 1 WHITE+**
 757121U **SPEERS ARM W BODY 2 WHITE+**
 757112U **SPEERS ARM W BODY 1 BLACK+**
 757122U **SPEERS ARM W BODY 2 BLACK+**





Lighting
systems



B.lux

Aspen

by
Werner Aisslinger

**Decorative
lighting**

Lighting
systems



Linear suspension system that allows combining the shades on the Aspen 17 lamps. Consists of a tubular structure available in three lengths that allows installing the shades at different distances. Structure painted in a matte black finish. The Aspen aluminum shades are available in these finishes: grey, snow, lemon, mango, clear turquoise, aqua, merlot, rose, sea, river, limestone, black and brass.

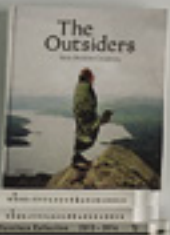

Aspen



ASPEN SH CONNECTION 55 / 80 / 110

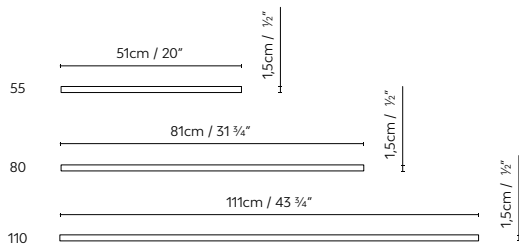

ASPEN SH A

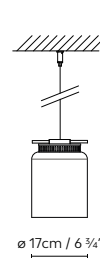

ASPEN SH B

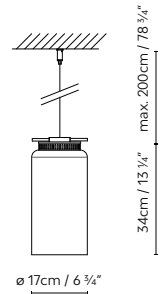

ASPEN SH POWER SUPPLY

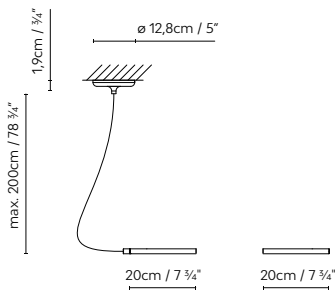

ASPEN SH INSTALLATION EXAMPLE

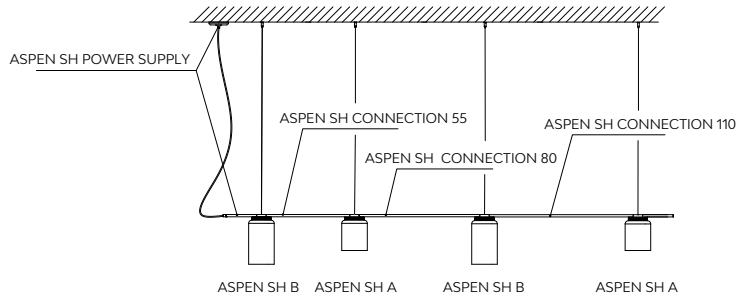

- SHADE:**
- Grey (matte)
 - Mango (matte)
 - Merlot (matte)
 - Rose (matte)
 - Brass (matte)
 - Snow (matte)
 - Clear turquoise (matte)
 - River (matte)
 - Limestone (matte)
 - Lemon (matte)
 - Aqua (matte)
 - Sea (matte)
 - Black (matte)
- RING:**
- Black (matte)

750302U	ASPEN SH A E26	LED 15W (E26)/ Fluo. CFL max. 30W (E26) / Inc. max. 70W (E26)
750303U	ASPEN SH B E26	
750320U	ASPEN SH POWER SUPPLY	
750330U	ASPEN SH CONNECTION 55	
750340U	ASPEN SH CONNECTION 80	
750350U	ASPEN SH CONNECTION 110	



B.lux

C_Ball System

by
Stone Designs

**Decorative
lighting**

Lighting
systems

Lighting system that allows adapting the lighting to the spaces by using different wall or ceiling accessories. It is a tubular system to which lighted blown-glass spheres in an opal white finish, from the C_Ball decorative lamp collection, are attached. Its metal parts are available in a matte black finish.



C_Ball System



C_BALL S CURRENT SUPPLY

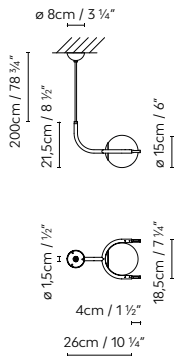

C_BALL S SINGLE SUSPENSION

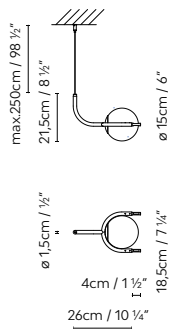

C_BALL SYSTEM S 90°H CURRENT SUPPLY

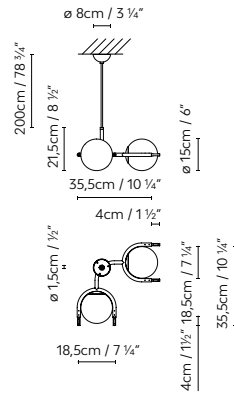

C_BALL SYSTEM S 90°H SINGLE SUSPENSION

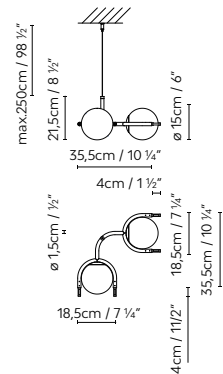

C_BALL SYSTEM C/W 90°H CURRENT SUPPLY

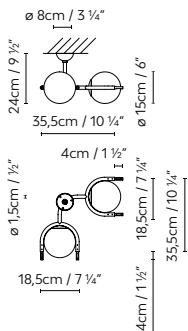

C_BALL SYSTEM C/W CURRENT SUPPLY

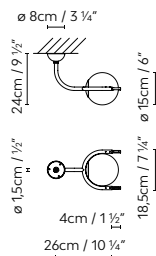

C_BALL SYSTEM C/W 90°V CURRENT SUPPLY

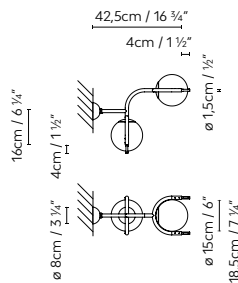

C_BALL SYSTEM LIGHT MODULE

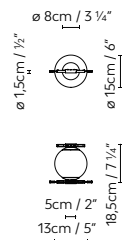

C_BALL SYSTEM SUSPENSION CABLE

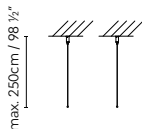

C_BALL SYSTEM LINEAR UNION JOIN

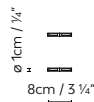

C_BALL SYST. LINEAR UNION 30/50/80/110

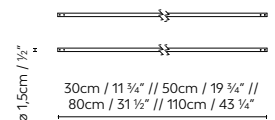

● Black (matte)

748905U	C_BALL SYSTEM S CURRENT SUPPLY	LED 6W (E12) / Fluo. CFL max. 12W (E12) / Inc. max. 40W (E12)
748915U	C_BALL SYSTEM S SINGLE SUSPENSION	LED 6W (E12) / Fluo. CFL max. 12W (E12) / Inc. max. 40W (E12)
748925U	C_BALL SYSTEM S 90°H CURRENT SUPPLY	LED 2 x 6W (E12) / Fluo. CFL max. 2 x 12W (E12) / Inc. max. 2 x 40W (E12)
748935U	C_BALL SYSTEM S 90°H SINGLE SUSPENSION	LED 2 x 6W (E12) / Fluo. CFL max. 2 x 12W (E12) / Inc. max. 2 x 40W (E12)
748945U	C_BALL SYSTEM C/W CURRENT SUPPLY	LED 6W (E12) / Fluo. CFL max. 12W (E12) / Inc. max. 40W (E12)
748955U	C_BALL SYSTEM C/W 90°H CURRENT SUPPLY	LED 2 x 6W (E12) / Fluo. CFL max. 2 x 12W (E12) / Inc. max. 2 x 40W (E12)
748965U	C_BALL SYSTEM C/W 90°V CURRENT SUPPLY	LED 2 x 6W (E12) / Fluo. CFL max. 2 x 12W (E12) / Inc. max. 2 x 40W (E12)
748985U	C_BALL SYSTEM LIGHT MODULE	LED 6W (E12) / Fluo. CFL max. 12W (E12) / Inc. max. 40W (E12)
748975U	C_BALL SYST. LINEARUNION 30	
748976U	C_BALL SYST. LINEARUNION 50	
748977U	C_BALL SYST. LINEARUNION 80	
748978U	C_BALL SYST. LINEARUNION 110	
748980U	C_BALL SYSTEM LINEARUNION JOIN	
748995U	C_BALL SYSTEM SUSPENSION CABLE	

C_Ball System



C_BALL SYSTEM INSTALLATION EXAMPLES

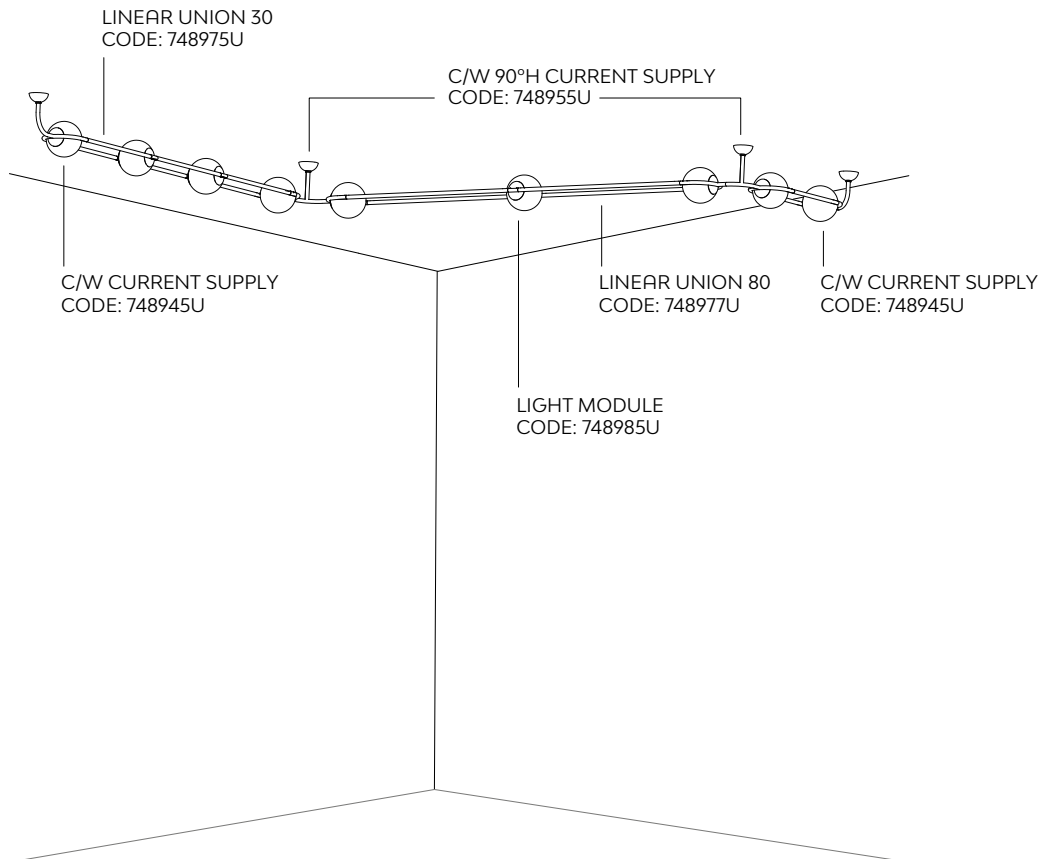
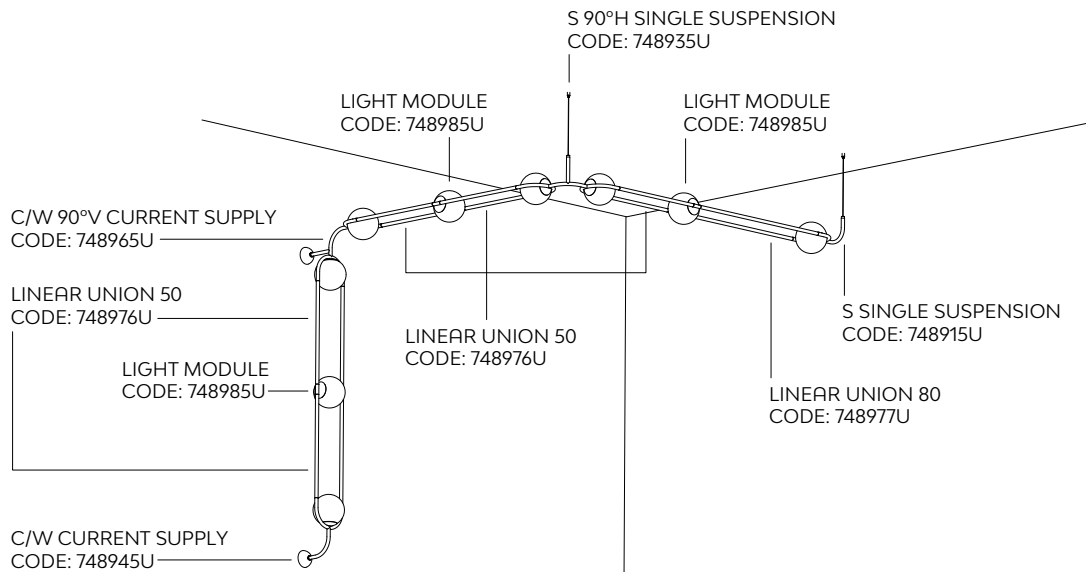

B.lux

Kup

by
e27, Tim Brauns

**Decorative
lighting**

Lighting
systems

Adjustable modular suspension LED system that allows for multiple arrangements. Marketed in two standard formats: Kup 1 and Kup 2. Each lamp consists of five adjustable light bodies offering direct light. The structure of the Kup lamp features a black finish, while the light bodies are offered in black, gold and copper finishes. The diffusers are made from acrylic and have a white opal matte finish. Additional modules can be supplied, consisting of one structure and two heads, thus increasing the dimensions of the lamp to better adapt to the available surface area and space. This module can be plugged into any of the end caps on the standard lamps (Kup 1 and Kup 2).



Kup



KUP 1

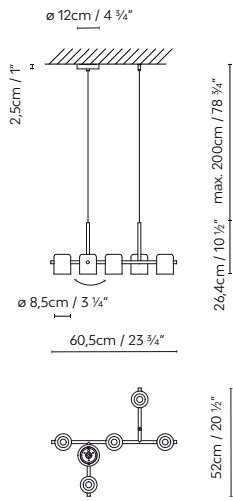

KUP 2

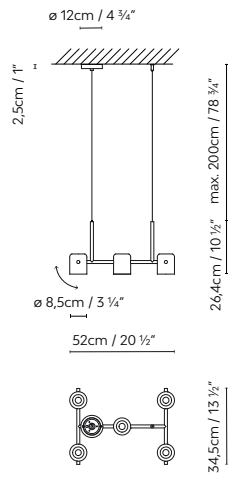

KUP MODULE



EXAMPLES:

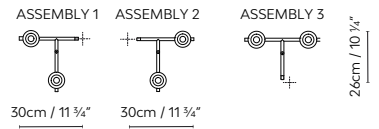

KUP INSTALLATION EXAMPLES

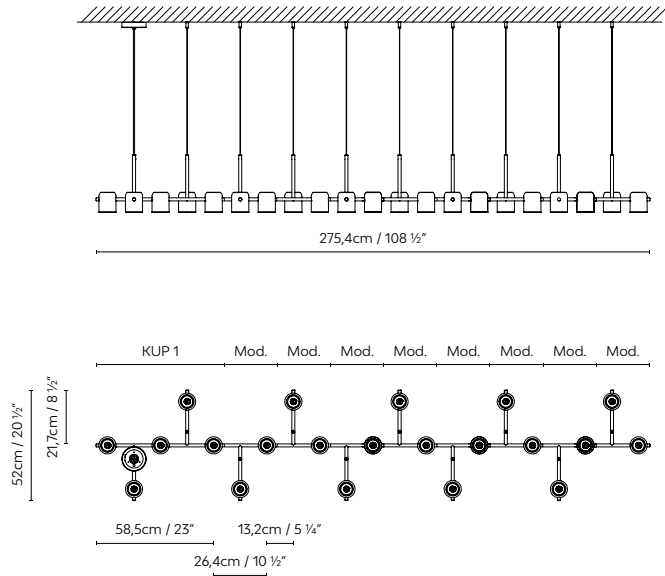
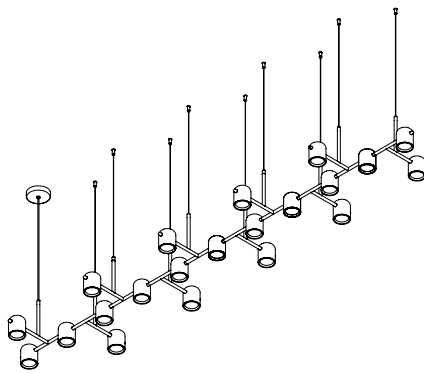

- Black (matte)
- Gold (satin)
- Copper (satin)

- 742310U **KUP 1** BLACK
- 742311U **KUP 1** GOLD
- 742312U **KUP 1** COPPER
- 742320U **KUP 2** BLACK
- 742321U **KUP 2** GOLD
- 742322U **KUP 2** COPPER

LED 5 x 8W 2800lm 2700K CRI≥90 120V DIM PHASE CUT

- 742900U **KUP MODULE** BLACK
- 742901U **KUP MODULE** GOLD
- 742902U **KUP MODULE** COPPER

LED 2 x 8W 1120lm 2700K CRI≥90 120V DIM PHASE CUT



B.lux

Kupetz

by
E27 Tim Brauns

**Decorative
lighting**

Lighting
systems

3D light system made with different light sources and unions, and its arrangement allows you to adjust the lighting to each space. This is a metal tubular system in matte black where you can combine four types of light sources: two opal white glass spheres (100 Glass and 150 Glass) and a spotlight with LED reflector that is available with different opening angles (Reflector) or a spotlight with opal diffuser (Diffuser). These spotlights and the base of the glass spheres come in three different finishes: black, copper and gold.



Kupetz



KUPETZ INSTALLATION EXAMPLES

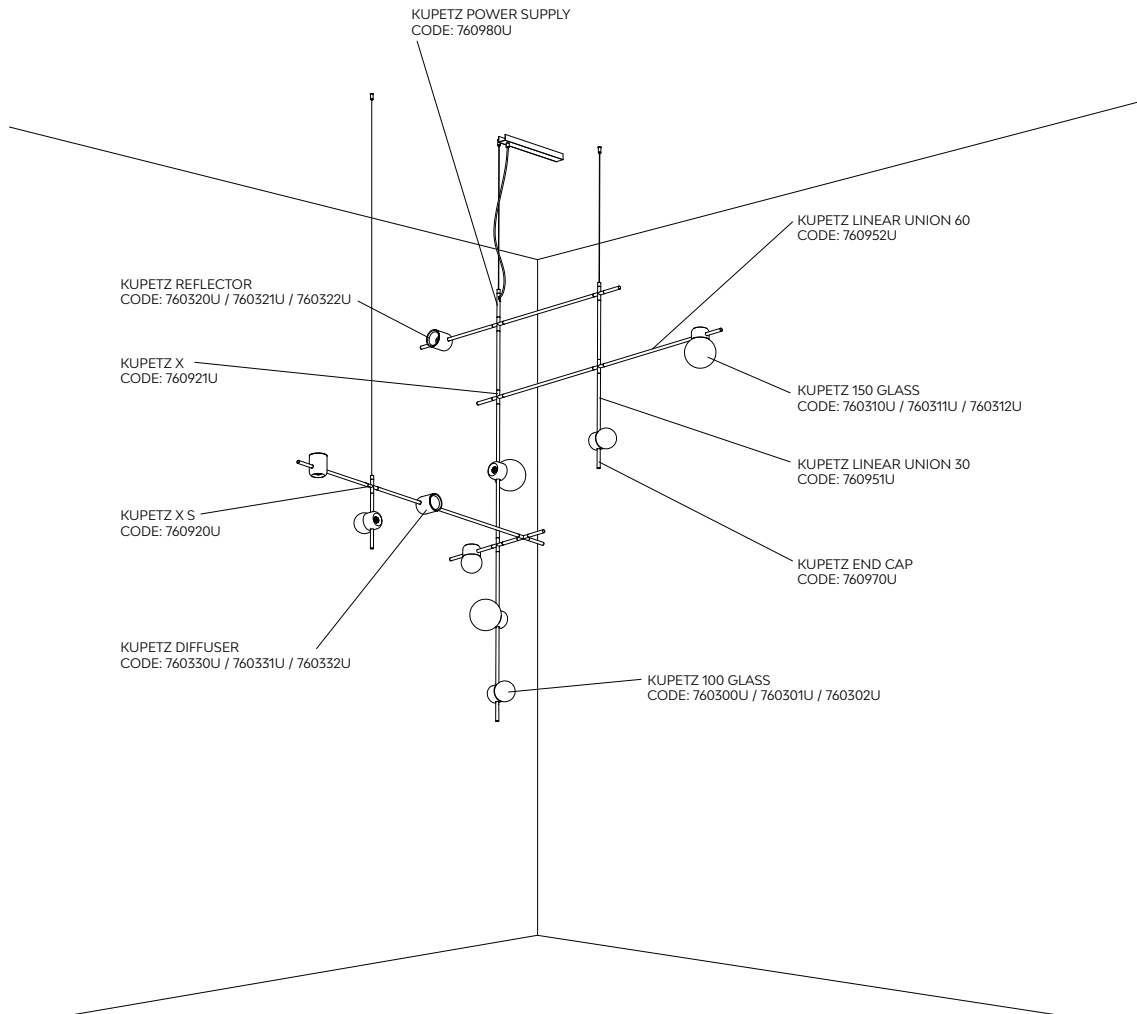
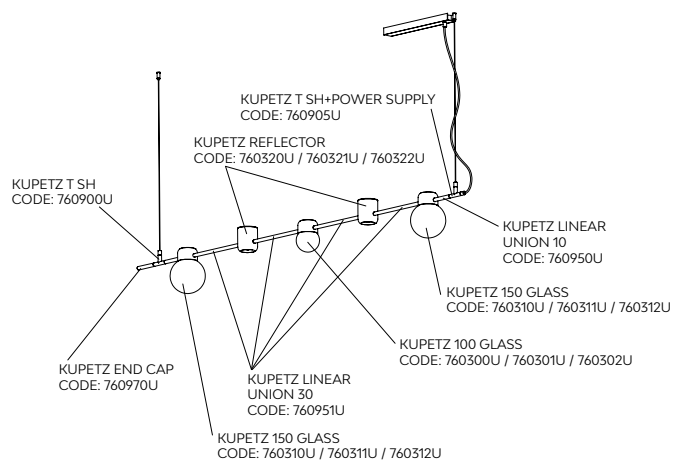
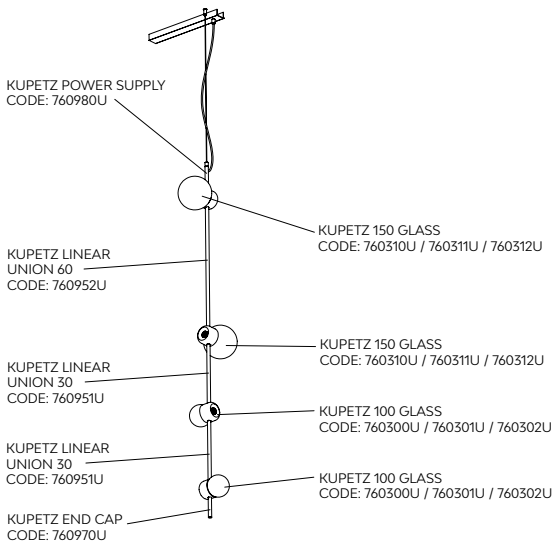

Kupetz



KUPETZ REFLECTOR

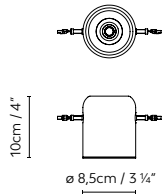

KUPETZ DIFFUSER

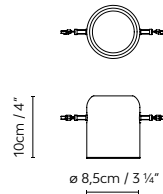

KUPETZ 150 GLASS

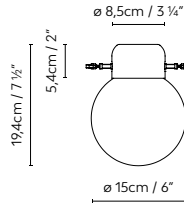

KUPETZ 100 GLASS

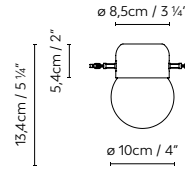

KUPETZ X

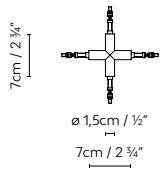

KUPETZ X S

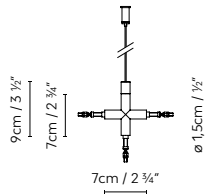

KUPETZ X S + POWER SUPPLY

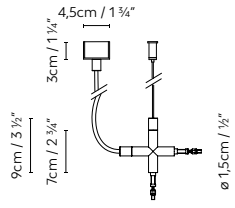

KUPETZ T

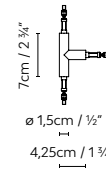

KUPETZ T SH

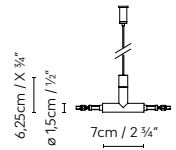

KUPETZ T SV

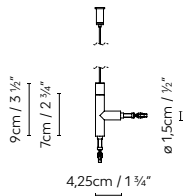

KUPETZ T SH + POWER SUPPLY

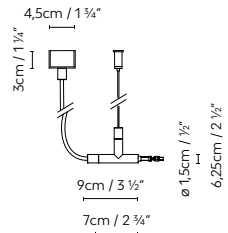

KUPETZ T SV + POWER SUPPLY

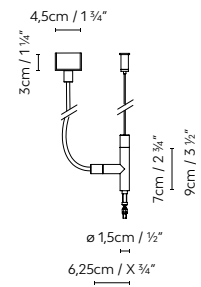

KUPETZ POWER SUPPLY

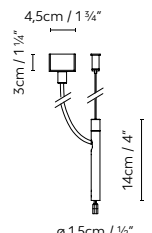

KUPETZ LINEAR UNION 10/30/60/90/120

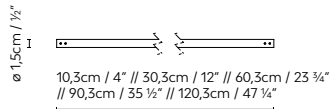

KUPETZ END CAP

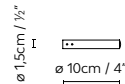

* Steel cable L: 200cm / 78 3/4"
* Electric cable L: 250cm / 98 1/2"

● Black (matte) ● Gold (satin) ● Copper (satin)

760300U	KUPETZ 100 GLASS BLACK	LED 6,3W 570lm
760301U	KUPETZ 100 GLASS GOLD	350mA 2700K CRI≥90
760302U	KUPETZ 100 GLASS COPPER	120V DIM 1-10V
760310U	KUPETZ 150 GLASS BLACK	LED 6,3W 570lm
760311U	KUPETZ 150 GLASS GOLD	350mA 2700K CRI≥90
760312U	KUPETZ 150 GLASS COPPER	120V DIM 1-10V
760320U	KUPETZ REFLECTOR BLACK	LED 6,3W 570lm
760321U	KUPETZ REFLECTOR GOLD	350mA 2700K CRI≥90
760322U	KUPETZ REFLECTOR COPPER	120V DIM 1-10V
760330U	KUPETZ DIFFUSER BLACK	LED 6,3W 570lm
760331U	KUPETZ DIFFUSER GOLD	350mA 2700K CRI≥90
760332U	KUPETZ DIFFUSER COPPER	120V DIM 1-10V
760970U	KUPETZ END CAP	

760911U	KUPETZ T
760900U	KUPETZ T SH
760910U	KUPETZ T SV
760905U	KUPETZ T SH + POWER SUPPLY
760915U	KUPETZ T SV + POWER SUPPLY
760921U	KUPETZ X
760920U	KUPETZ X S
760925U	KUPETZ X S + POWER SUPPLY
760980U	KUPETZ POWER SUPPLY
760950U	KUPETZ LINEARUNION 10
760951U	KUPETZ LINEARUNION 30
760952U	KUPETZ LINEARUNION 60
760953U	KUPETZ LINEARUNION 90
760954U	KUPETZ LINEARUNION 120
760960U	KUPETZ REFLECTOR LENSE 42°
760961U	KUPETZ REFLECTOR LENSE 59°
760962U	KUPETZ REFLECTOR LENSE 130°



B.lux

Architectural lighting

B.lux

Anvil System

by
David Abad

Architectural
lighting



A surface-mounted or suspension lighting system made of extruded aluminum. Installable with continuous LED light modules with an opal diffuser (LED Line), or LED modules featuring four or two spots (LED Module), or LED spotlights (LED Spotlight and Spot S) available with anti-glare rings and beehive design. It also allows the installation of slim LED spotlights (LED Spotlight Slim). As a new feature, the Anvil System also allows the addition of round opal white glass diffusers that can be fixed to the rail (Sphere C) or hung (Sphere S). The Anvil System profile is available in matte white, matte black, natural oak and natural walnut.



Anvil System





PROFILES

ANVIL SYSTEM SUSPENSION/SURFACE PROFILE

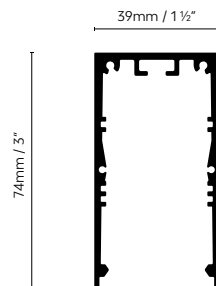

Black (matte)
 White (matte)
 Oak
 Walnut

851940 ANVIL SYSTEM SUSPENSION/SURFACE PROFILE BLACK

851941 ANVIL SYSTEM SUSPENSION/SURFACE PROFILE WHITE

851942 ANVIL SYSTEM SUSPENSION/SURFACE PROFILE OAK

851944 ANVIL SYSTEM SUSPENSION/SURFACE PROFILE WALNUT



Anvil System



LIGHT SOURCES

ANVIL SYSTEM LED LINE

(LED included) **A+**

Continuous LED light module with opal diffuser, for its integration into the Anvil System.

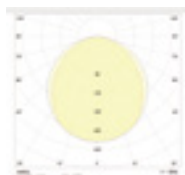
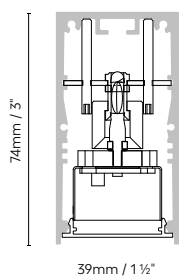

851840C	ANVIL SYSTEM LED LINE C420 SURFACE	420mm / 16 1/2"	LED 7,6W 1326lm 450mA 3000K CRI≥90
851840S	ANVIL SYSTEM LED LINE S420 SUSPENSION		
851850C	ANVIL SYSTEM LED LINE C560 SURFACE	560mm / 22"	LED 10,2W 1768lm 450mA 3000K CRI≥90
851850S	ANVIL SYSTEM LED LINE S560 SUSPENSION		
851860C	ANVIL SYSTEM LED LINE C700 SURFACE	700mm / 27 1/2"	LED 12,7W 2210lm 450mA 3000K CRI≥90
851860S	ANVIL SYSTEM LED LINE S700 SUSPENSION		
851870C	ANVIL SYSTEM LED LINE C840 SURFACE	840mm / 33"	LED 15,2W 2652lm 450mA 3000K CRI≥90
851870S	ANVIL SYSTEM LED LINE S840 SUSPENSION		
851880C	ANVIL SYSTEM LED LINE C1120 SURFACE	1120mm / 44"	LED 20,5W 3536lm 450mA 3000K CRI≥90
851880S	ANVIL SYSTEM LED LINE S1120 SUSPENSION		
851999U2	ANVIL SYSTEM DRIVER 120V 50W ON-OFF/DIM 1-10V		DIM 1-10V



LIGHT SOURCES

ANVIL SYSTEM LED MODULE

(LED included) **A+** 

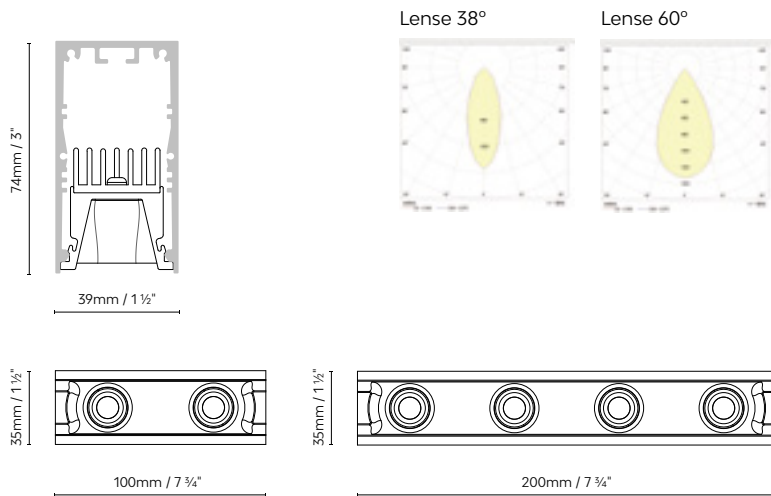

LED module equipped with four or two spots, for integration into the Anvil System. Finishes: matte white or matte black.

851600	ANVIL SYSTEM LED MODULE 4 38° BLACK	LED 4 x 4,5W 2184lm 250mA 3000K CRI≥90
851601	ANVIL SYSTEM LED MODULE 4 38° WHITE	
851610	ANVIL SYSTEM LED MODULE 4 60° BLACK	
851611	ANVIL SYSTEM LED MODULE 4 60° WHITE	
851620	ANVIL SYSTEM LED MODULE 2 38° BLACK	LED 2 x 4,5W 1092lm 250mA 3000K CRI≥90
851621	ANVIL SYSTEM LED MODULE 2 38° WHITE	
851630	ANVIL SYSTEM LED MODULE 2 60° BLACK	
851631	ANVIL SYSTEM LED MODULE 2 60° WHITE	
851999U2	ANVIL SYSTEM DRIVER 120V 50W ON-OFF/DIM 1-10V	DIM 1-10V

Anvil System

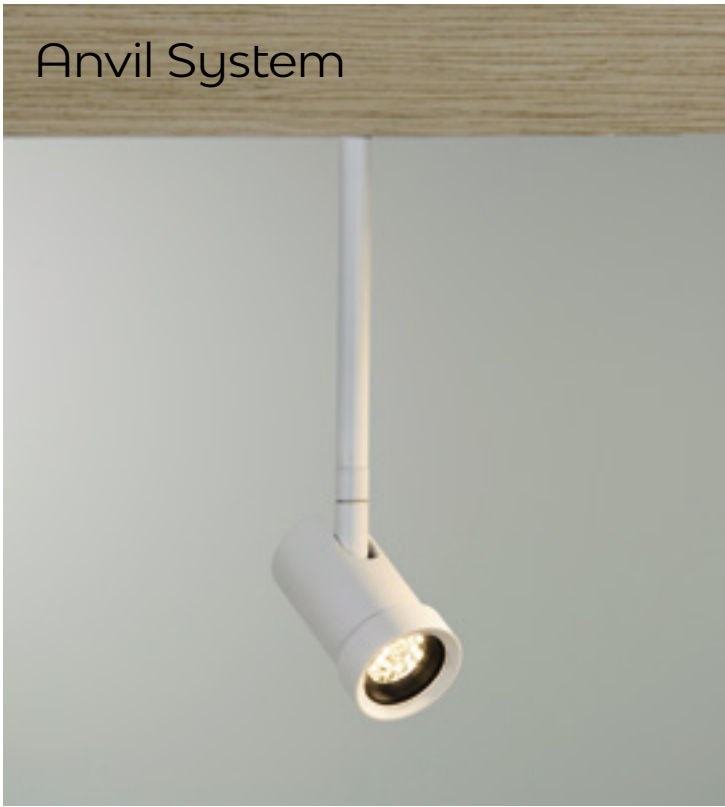

LIGHT SOURCES

ANVIL SYSTEM LED SPOTLIGHT

(LED included)

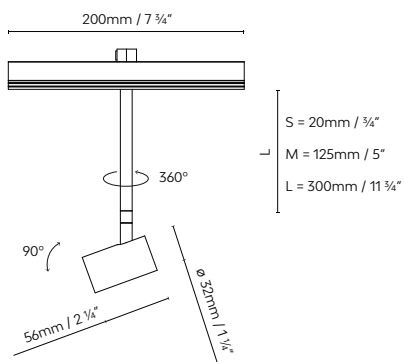

Lense 38°

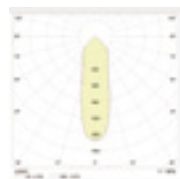

Lense 60°

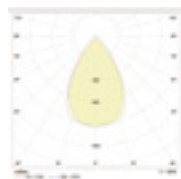

LED projectors of different sizes (S, M, L), for integration into the Anvil System. Available with Anti-Glare Ring or Honeycomb Ring. Finishes: matte white or matte black.

851700	ANVIL SYSTEM LED SPOTLIGHT S 38° BLACK
851701	ANVIL SYSTEM LED SPOTLIGHT S 38° WHITE
851702	ANVIL SYSTEM LED SPOTLIGHT S 60° BLACK
851703	ANVIL SYSTEM LED SPOTLIGHT S 60° WHITE
851710	ANVIL SYSTEM LED SPOTLIGHT M 38° BLACK
851711	ANVIL SYSTEM LED SPOTLIGHT M 38° WHITE
851712	ANVIL SYSTEM LED SPOTLIGHT M 60° BLACK
851713	ANVIL SYSTEM LED SPOTLIGHT M 60° WHITE
851720	ANVIL SYSTEM LED SPOTLIGHT L 38° BLACK
851721	ANVIL SYSTEM LED SPOTLIGHT L 38° WHITE
851722	ANVIL SYSTEM LED SPOTLIGHT L 60° BLACK
851723	ANVIL SYSTEM LED SPOTLIGHT L 60° WHITE

LED 4,5W 546lm 250mA 3000K CRI≥90 110-277V

851999U2 **ANVIL SYSTEM DRIVER 120V 50W ON-OFF/DIM 1-10V**

DIM 1-10V



LIGHT SOURCES

ANVIL SYSTEM LED SPOTLIGHT SLIM

(LED included)

A+

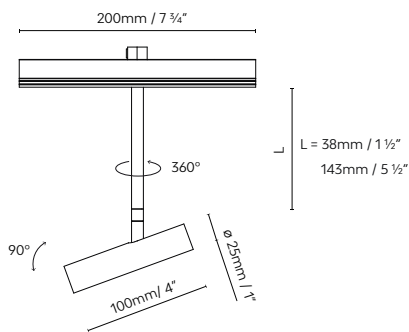

Lense 38°



Lense 60°

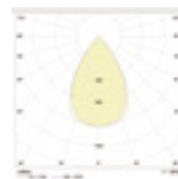

Slim LED spotlights in different sizes (S, M) to fit them into the Anvil System lighting arrangement. Finishes: matte white, matte black or gold.

851761	ANVIL SYSTEM LED SPOTLIGHT SLIM S 38° WHITE
851760	ANVIL SYSTEM LED SPOTLIGHT SLIM S 38° BLACK
851764	ANVIL SYSTEM LED SPOTLIGHT SLIM S 38° GOLD
851763	ANVIL SYSTEM LED SPOTLIGHT SLIM S 60° WHITE
851762	ANVIL SYSTEM LED SPOTLIGHT SLIM S 60° BLACK
851765	ANVIL SYSTEM LED SPOTLIGHT SLIM S 60° GOLD
851771	ANVIL SYSTEM LED SPOTLIGHT SLIM M 38° WHITE
851770	ANVIL SYSTEM LED SPOTLIGHT SLIM M 38° BLACK
851774	ANVIL SYSTEM LED SPOTLIGHT SLIM M 38° GOLD
851773	ANVIL SYSTEM LED SPOTLIGHT SLIM M 60° WHITE
851772	ANVIL SYSTEM LED SPOTLIGHT SLIM M 60° BLACK
851775	ANVIL SYSTEM LED SPOTLIGHT SLIM M 60° GOLD

LED 4,5W 546lm 250mA 3000K CRI≥90 110-277V

851999U2 ANVIL SYSTEM DRIVER 120V 50W ON-OFF/DIM 1-10V

DIM 1-10V

Anvil System

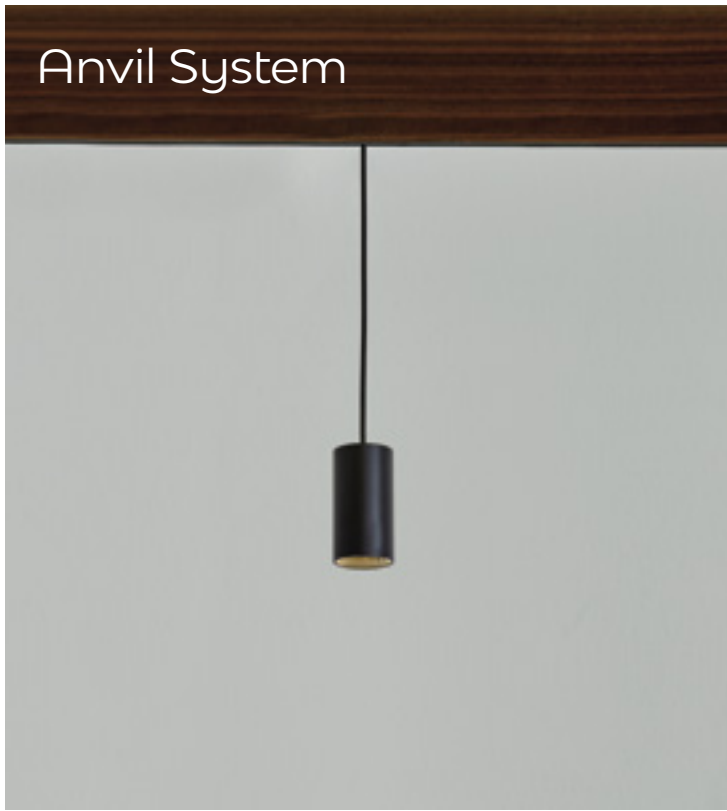

LIGHT SOURCES

ANVIL SYSTEM LED SPOT S

(LED included)

A+

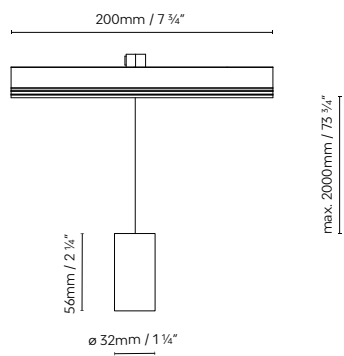

Lense 38°

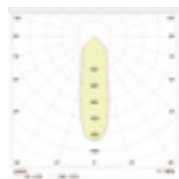

Lense 60°

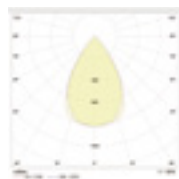

LED spotlights that hang from the Anvil System lighting arrangement. Available with anti-glare rings and Honeycomb rings. Finishes: matte white or matte black.

851750	ANVIL SYSTEM LED SPOT S-38° BLACK
851751	ANVIL SYSTEM LED SPOT S-38° WHITE
851752	ANVIL SYSTEM LED SPOT S-60° BLACK
851753	ANVIL SYSTEM LED SPOT S-60° WHITE

LED 4,5W 546lm 250mA 3000K CRI≥90 110-277V

851999U2	ANVIL SYSTEM DRIVER 120V 50W ON-OFF/DIM 1-10V
----------	--

DIM 1-10V



LIGHT SOURCES

ANVIL SYSTEM SPHERE S

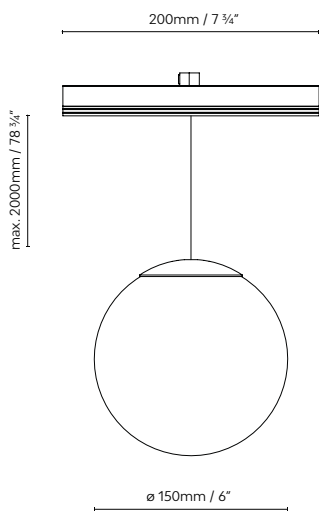

ANVIL SYSTEM SPHERE C

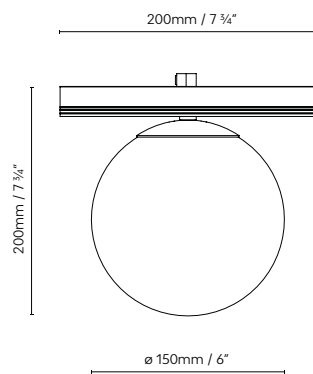

(LED included)

A+

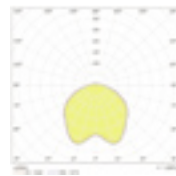

Round opal white glass diffuser to install on the Anvil System rail. The metal parts come in matte white or matte black.

851740	ANVIL SYSTEM SPHERE S BLACK	LED 4,5W 546lm 250mA 3000K CRI≥90 110-277V
851741	ANVIL SYSTEM SPHERE S WHITE	
851730	ANVIL SYSTEM SPHERE C BLACK	LED 4,5W 546lm 250mA 3000K CRI≥90 110-277V
851731	ANVIL SYSTEM SPHERE C WHITE	
851999U2	ANVIL SYSTEM DRIVER 120V 50W ON-OFF/DIM 1-10V	DIM 1-10V

Anvil System



ACCESSORIES

ANVIL SYSTEM COVER PROFILE

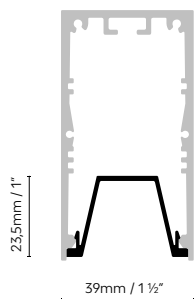

ANVIL SYSTEM FLAT COVER PROFILE



- 851960 **ANVIL SYSTEM COVER PROFILE BLACK**
851961 **ANVIL SYSTEM COVER PROFILE WHITE**

- 851970 **ANVIL SYSTEM FLAT COVER PROFILE BLACK**
851971 **ANVIL SYSTEM FLAT COVER PROFILE WHITE**

ANVIL SYSTEM 180° ANGLE

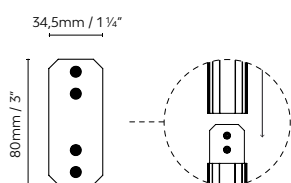

ANVIL SYSTEM 135° ANGLE

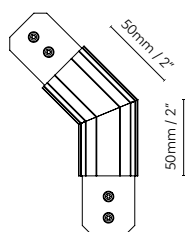

ANVIL SYSTEM 90° ANGLE

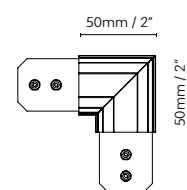

- 851930 **ANVIL SYSTEM 180° ANGLE**

- 851920 **ANVIL SYSTEM 135° ANGLE SUSPENSION/SURFACE BLACK**
851921 **ANVIL SYSTEM 135° ANGLE SUSPENSION/SURFACE WHITE**
851922 **ANVIL SYSTEM 135° ANGLE SUSPENSION/SURFACE OAK**
851923 **ANVIL SYSTEM 135° ANGLE SUSPENSION/SURFACE WALNUT**

- 851910 **ANVIL SYSTEM 90° ANGLE SUSPENSION/SURFACE BLACK**
851911 **ANVIL SYSTEM 90° ANGLE SUSPENSION/SURFACE WHITE**
851912 **ANVIL SYSTEM 90° ANGLE SUSPENSION/SURFACE OAK**
851913 **ANVIL SYSTEM 90° ANGLE SUSPENSION/SURFACE WALNUT**

Anvil System



ACCESSORIES

ANVIL SYSTEM END CAP

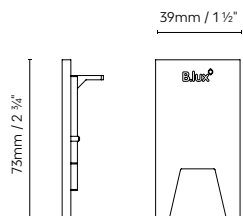

ANVIL SYSTEM LED LINE END CAP

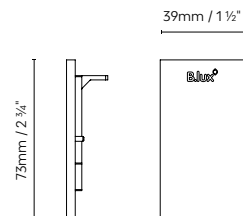

851900	ANVIL SYSTEM END CAP BLACK (2UN.)
851901	ANVIL SYSTEM END CAP WHITE (2UN.)
851906	ANVIL SYSTEM LED LINE END CAP BLACK (2UN.)
851907	ANVIL SYSTEM LED LINE END CAP WHITE (2UN.)

ANVIL SYSTEM SINGLE SUSPENSION



ANVIL SYSTEM WALL FIXATION

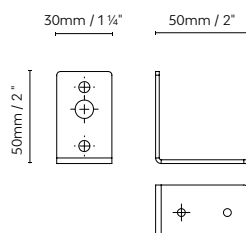

ANVIL SYSTEM CURRENT SUPPLY

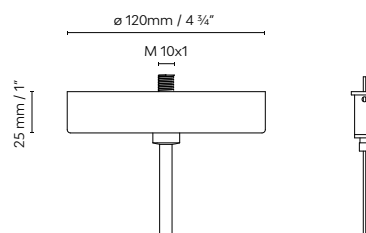

851905	ANVIL SYSTEM WALL FIXATION
851985U	ANVIL SYSTEM DIM CURRENT SUPPLY BLACK
851986U	ANVIL SYSTEM DIM CURRENT SUPPLY WHITE
851990	ANVIL SYSTEM SINGLE SUSPENSION

ANVIL SYSTEM ANTI-GLARE RING



ANVIL SYSTEM ANTI-GLARE RING + HONEYCOMB



851790	ANVIL SYSTEM LED SPOT ANTI-GLARE RING BLACK
851791	ANVIL SYSTEM LED SPOT ANTI-GLARE RING WHITE
851792	ANVIL SYSTEM LED SPOT ANTI-GLARE RING + HONEYCOMB BLACK
851793	ANVIL SYSTEM LED SPOT ANTI-GLARE RING + HONEYCOMB WHITE

Anvil System

ONLINE CONFIGURATOR EXAMPLE

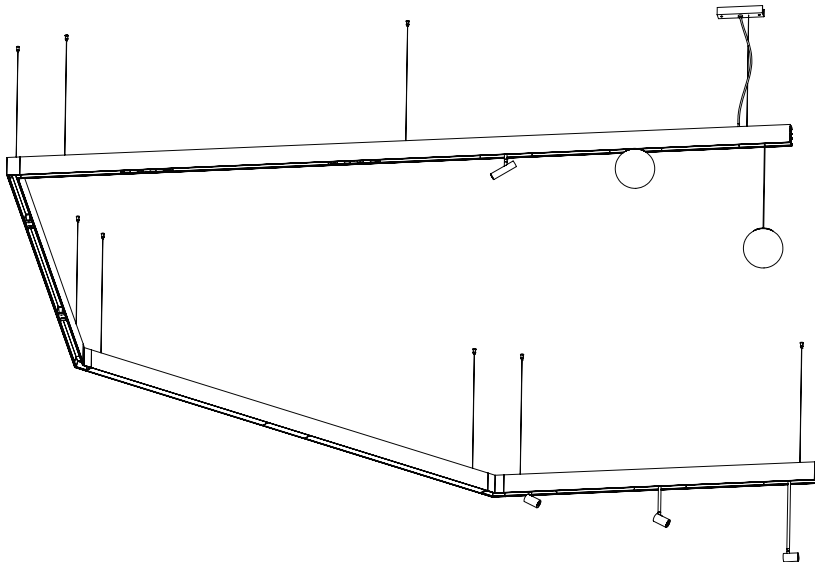
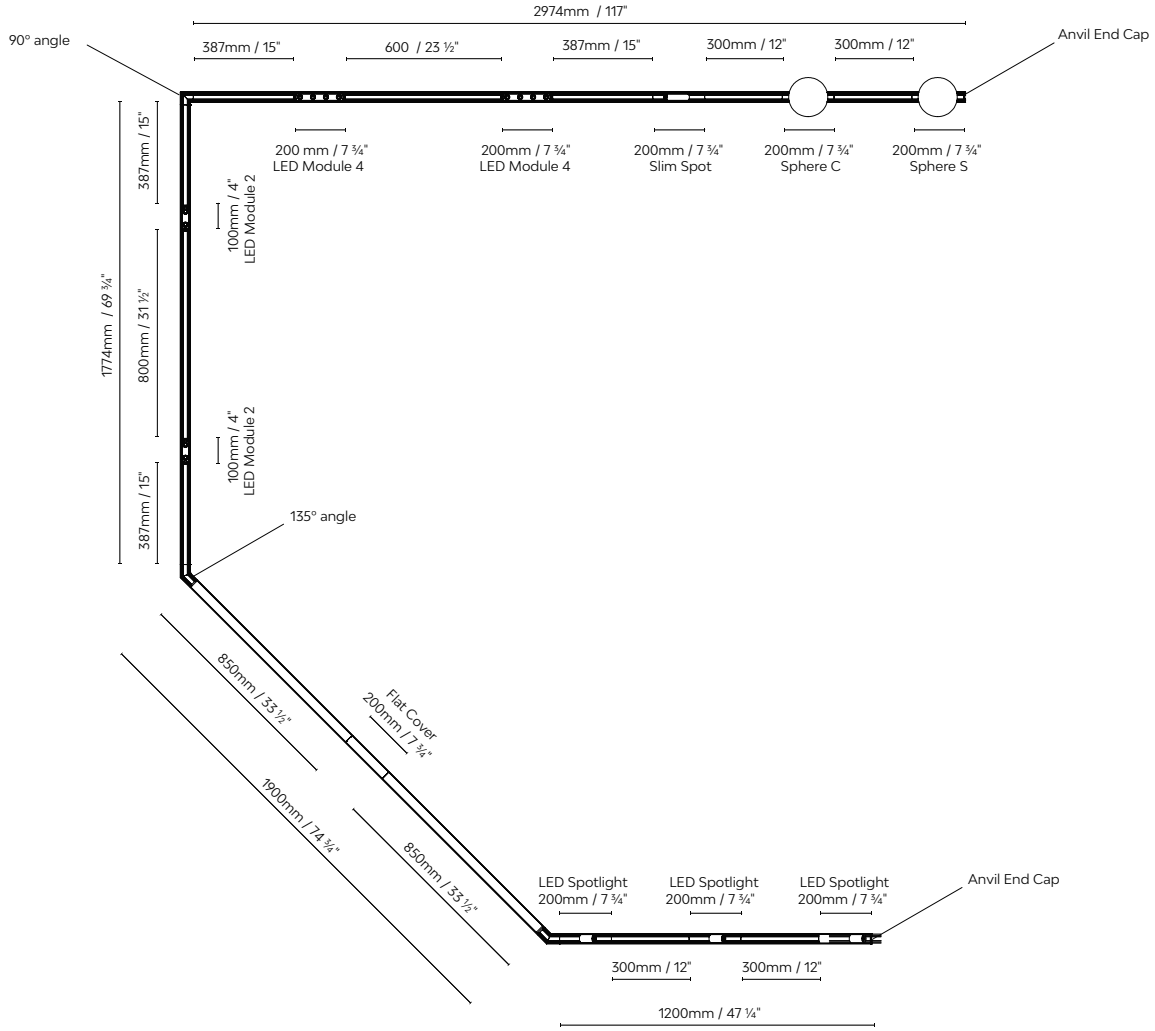

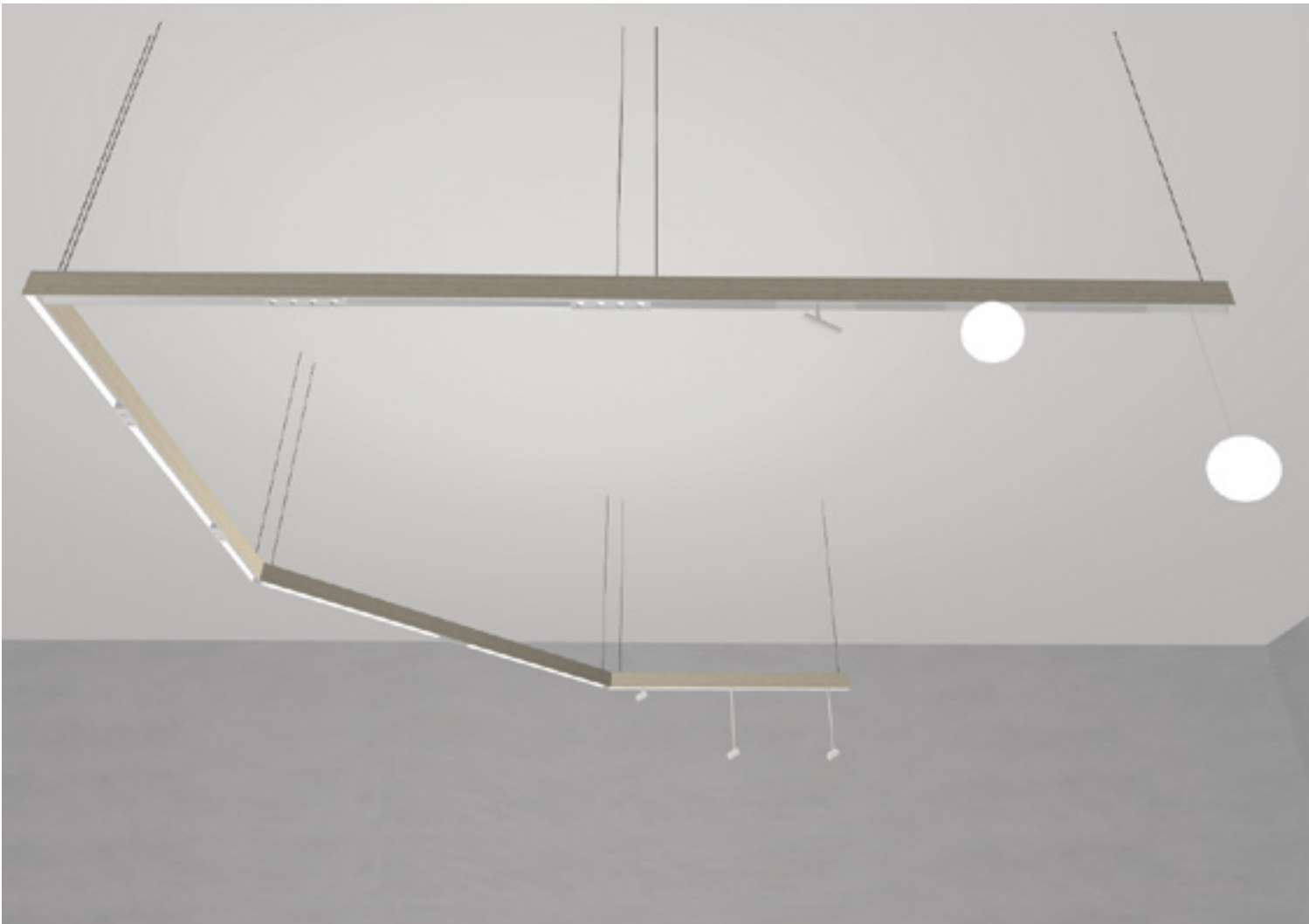
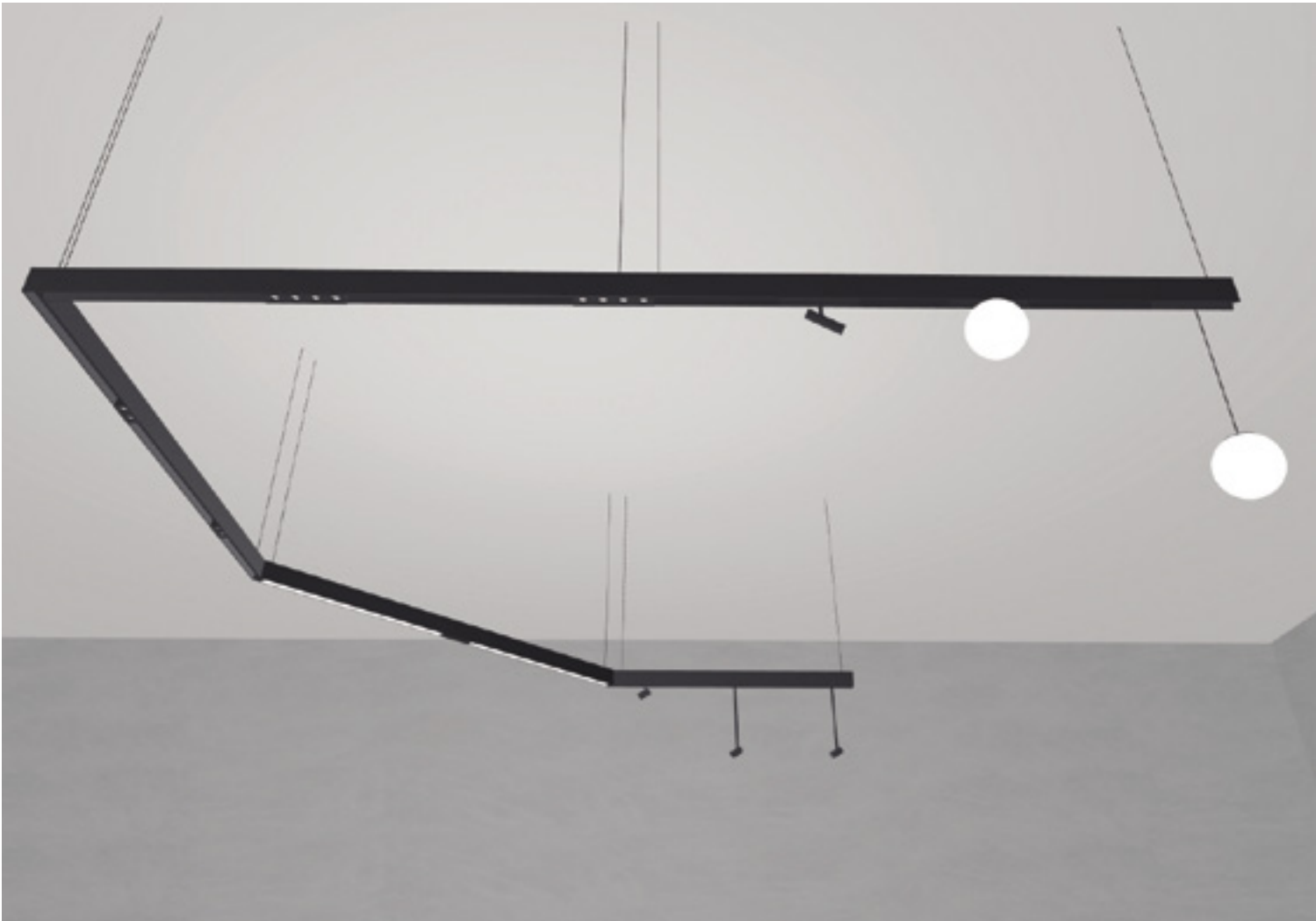

B.lux

Anvil Spot

by
David Abad

Architectural
lighting

A collection of LED projectors made of aluminum, with direct light. It is sold in a surface suspension version (Anvil Spot S) and a suspension model with a recessed rosette (Anvil Spot SR). Finishes: matte white or matte black.



ANVIL SPOT S

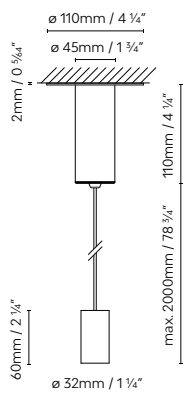

ANVIL SPOT SR

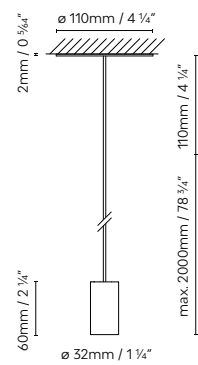

● Black (matte) ○ White (matte)

851220U **ANVIL SPOT S 38° BLACK**
 851221U **ANVIL SPOT S 38° WHITE**
 851222U **ANVIL SPOT S 60° BLACK**
 851223U **ANVIL SPOT S 60° WHITE**

LED 4,5W 546lm
 250mA 3000K
 CRI≥90 120V

851230U **ANVIL SPOT SR 38° BLACK**
 851231U **ANVIL SPOT SR 38° WHITE**
 851232U **ANVIL SPOT SR 60° BLACK**
 851233U **ANVIL SPOT SR 60° WHITE**

LED 4,5W 546lm 250mA
 3000K CRI≥90 120V



B.lux

Anvil Slim Spot

by
David Abad

Architectural
lighting

Collection of LED ceiling spotlights with direct light that stand out for their slim design. Made in aluminum and available in matte white, matte black and gold.



ANVIL SLIM SPOT CR

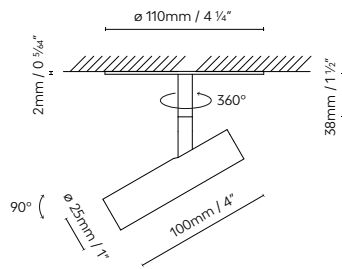
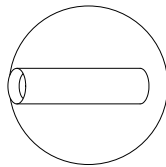

- Black (matte)
- White (matte)
- Gold (matte)

851270U	ANVIL SLIM SPOT CR 38° BLACK	
851271U	ANVIL SLIM SPOT CR 38° WHITE	LED 4,5W 546lm 250mA 3000K CRI≥90 120V
851272U	ANVIL SLIM SPOT CR 38° GOLD	

851280U	ANVIL SLIM SPOT CR 60° BLACK	
851281U	ANVIL SLIM SPOT CR 60° WHITE	LED 4,5W 546lm 250mA 3000K CRI≥90 120V
851282U	ANVIL SLIM SPOT CR 60° GOLD	



B.lux

Anvil Sphere

by
David Abad

Architectural
lighting

A collection of surface or suspension round opal white glass diffusers. The metal parts and cable come in matte white or matte black.



ANVIL SPHERE SR

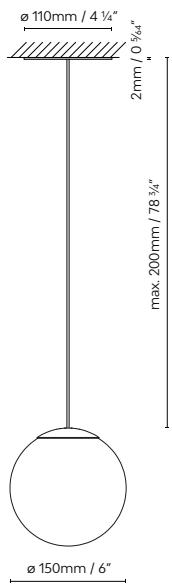

ANVIL SPHERE CR

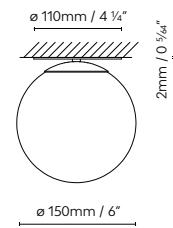

● Black (matte) ○ White (matte)

851290U	ANVIL SPHERE SR BLACK	LED 4,5W 546lm 250mA 3000K CRI≥90 120V
851291U	ANVIL SPHERE SR WHITE	
851296U	ANVIL SPHERE CR BLACK	LED 4,5W 546lm 250mA 3000K CRI≥90 120V
851297U	ANVIL SPHERE CR WHITE	



B.lux

Marc

by
David Abad

**Architectural
lighting**

Collection composed of a suspension (S), ceiling (C), and two wall (W and ARM) versions. Made of aluminum, they feature an opal polycarbonate diffuser and emit direct (1L) or indirect (1L) light, or both (2L), except for the Marc C (1L). The entire collection is available in different finishes: matte grey, satin white, satin black, and oak laminate.



Marc





MARC S (1L - 2L)

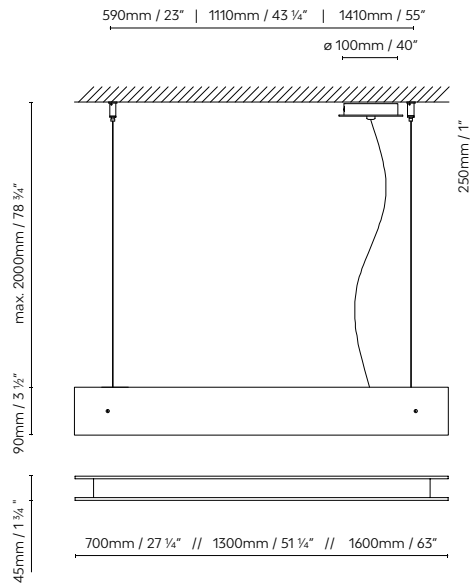

- Grey (matte)
- White (matte)
- Black (satin)
- Oak

839350D	MARC S70 (1L) LED DIM GREY	LED 10,2W 1768lm
839351D	MARC S70 (1L) LED DIM WHITE	450mA 3000K
839352D	MARC S70 (1L) LED DIM BLACK	CRI≥90 110-277V
839353D	MARC S70 (1L) LED DIM OAK	DIM 1-10V
839360D	MARC S130 (1L) LED DIM GREY	LED 20,5W 3536lm
839361D	MARC S130 (1L) LED DIM WHITE	450mA 3000K
839362D	MARC S130 (1L) LED DIM BLACK	CRI≥90 110-277V
839363D	MARC S130 (1L) LED DIM OAK	DIM 1-10V
839370D	MARC S160 (1L) LED DIM GREY	LED 25,4W 4420lm
839371D	MARC S160 (1L) LED DIM WHITE	450mA 3000K
839372D	MARC S160 (1L) LED DIM BLACK	CRI≥90 110-277V
839373D	MARC S160 (1L) LED DIM OAK	DIM 1-10V

839355D	MARC S70 (2L) LED DIM GREY	LED 2 x 10,2W
839356D	MARC S70 (2L) LED DIM WHITE	3536lm 450mA
839357D	MARC S70 (2L) LED DIM BLACK	3000K CRI≥90
839358D	MARC S70 (2L) LED DIM OAK	110-277V DIM 1-10V
839365D	MARC S130 (2L) LED DIM GREY	LED 2 x 20,5W
839366D	MARC S130 (2L) LED DIM WHITE	7072lm 450mA
839367D	MARC S130 (2L) LED DIM BLACK	3000K CRI≥90
839368D	MARC S130 (2L) LED DIM OAK	110-277V DIM 1-10V
839375D	MARC S160 (2L) LED DIM GREY	LED 2 x 25,4W
839376D	MARC S160 (2L) LED DIM WHITE	8840lm 450mA
839377D	MARC S160 (2L) LED DIM BLACK	3000K CRI≥90
839378D	MARC S160 (2L) LED DIM OAK	110-277V DIM 1-10V



Marc



MARC C

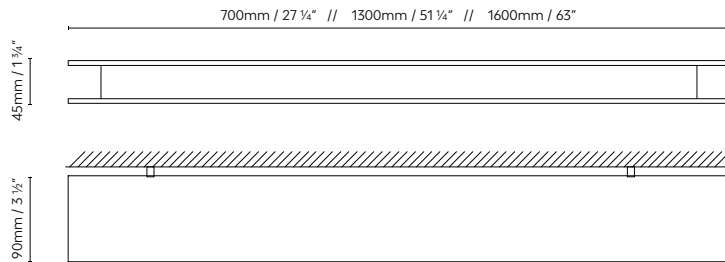

Grey (matte)
 White (matte)
 Black (satin)
 Oak

839450D	MARC C70 (1L) LED DIM GREY	LED 10,2W 1768lm
839451D	MARC C70 (1L) LED DIM WHITE	450mA 3000K
839452D	MARC C70 (1L) LED DIM BLACK	CRI≥90 110-110-
839453D	MARC C70 (1L) LED DIM OAK	277V DIM 1-10V

839460D	MARC C130 (1L) LED DIM GREY	LED 20,5W 3536lm
839461D	MARC C130 (1L) LED DIM WHITE	450mA 3000K
839462D	MARC C130 (1L) LED DIM BLACK	CRI≥90 110-277V
839463D	MARC C130 (1L) LED DIM OAK	DIM 1-10V

839470D	MARC C160 (1L) LED DIM GREY	LED 25,4W 4420lm
839471D	MARC C160 (1L) LED DIM WHITE	450mA 3000K
839472D	MARC C160 (1L) LED DIM BLACK	CRI≥90 110-277V
839473D	MARC C160 (1L) LED DIM OAK	DIM 1-10V





MARC W (1L - 2L)

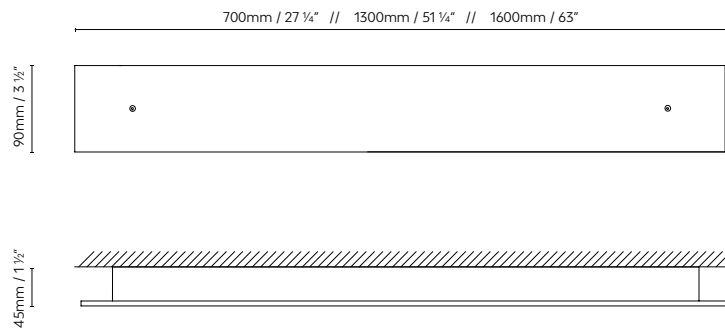

Grey (matte)
 White (matte)
 Black (satin)
 Oak

839150D	MARC W70 (1L) LED DIM GREY	LED 10,2W 1768lm
839151D	MARC W70 (1L) LED DIM WHITE	450mA 3000K
839152D	MARC W70 (1L) LED DIM BLACK	CRI≥90 110-110-277V
839153D	MARC W70 (1L) LED DIM OAK	DIM 1-10V
839160D	MARC W130 (1L) LED DIM GREY	LED 20,5W 3536lm
839161D	MARC W130 (1L) LED DIM WHITE	450mA 3000K
839162D	MARC W130 (1L) LED DIM BLACK	CRI≥90 110-277V
839163D	MARC W130 (1L) LED DIM OAK	DIM 1-10V
839170D	MARC W160 (1L) LED DIM GREY	LED 25,4W 4420lm
839171D	MARC W160 (1L) LED DIM WHITE	450mA 3000K
839172D	MARC W160 (1L) LED DIM BLACK	CRI≥90 110-277V
839173D	MARC W160 (1L) LED DIM OAK	DIM 1-10V

839155D	MARC W70 (2L) LED DIM GREY	LED 2 x 10,2W 3536lm
839156D	MARC W70 (2L) LED DIM WHITE	450mA 3000K CRI≥90
839157D	MARC W70 (2L) LED DIM BLACK	110-277V DIM 1-10V
839158D	MARC W70 (2L) LED DIM OAK	
839165D	MARC W130 (2L) LED DIM GREY	LED 2 x 20,5W 7072lm
839166D	MARC W130 (2L) LED DIM WHITE	450mA 3000K CRI≥90
839167D	MARC W130 (2L) LED DIM BLACK	110-277V DIM 1-10V
839168D	MARC W130 (2L) LED DIM OAK	
839175D	MARC W160 (2L) LED DIM GREY	LED 2 x 25,4W 8840lm
839176D	MARC W160 (2L) LED DIM WHITE	450mA 3000K CRI≥90
839177D	MARC W160 (2L) LED DIM BLACK	110-277V DIM 1-10V
839178D	MARC W160 (2L) LED DIM OAK	



REQUEST

Marc





MARC ARM (1L - 2L)

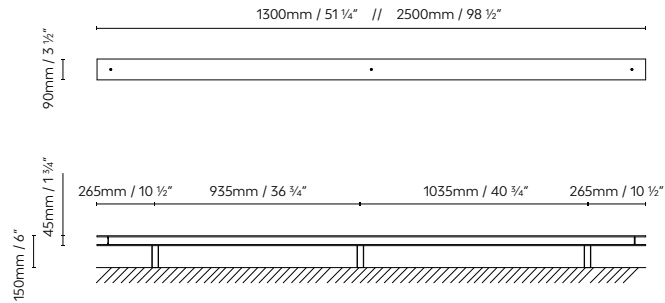

Grey (matte)
 White (matte)
 Black (satin)
 Oak

839560D	MARC ARM130 (1L) LED DIM GREY	LED 20,5W 3536lm
839561D	MARC ARM130 (1L) LED DIM WHITE	450mA 3000K
839562D	MARC ARM130 (1L) LED DIM BLACK	CRI≥90 110-277V
839563D	MARC ARM130 (1L) LED DIM OAK	DIM 1-10V

839580D	MARC ARM250 (1L) LED DIM GREY	LED 43,2W 7514lm
839581D	MARC ARM250 (1L) LED DIM WHITE	450mA 3000K
839582D	MARC ARM250 (1L) LED DIM BLACK	CRI≥90 110-277V
839583D	MARC ARM250 (1L) LED DIM OAK	DIM 1-10V

839565D	MARC ARM130 (2L) LED DIM GREY	LED 2 x 20,5W
839566D	MARC ARM130 (2L) LED DIM WHITE	7072lm 450mA
839567D	MARC ARM130 (2L) LED DIM BLACK	3000K CRI≥90
839568D	MARC ARM130 (2L) LED DIM OAK	110-277V DIM 1-10V

839585D	MARC ARM250 (2L) LED DIM GREY	LED 2 x 43,2W
839586D	MARC ARM250 (2L) LED DIM WHITE	15028lm 450mA
839587D	MARC ARM250 (2L) LED DIM BLACK	3000K CRI≥90
839588D	MARC ARM250 (2L) LED DIM OAK	110-277V DIM 1-10V



B.lux

Marc Dos

by
David Abad

Architectural
lighting

Collection composed of suspension (S) and wall (W) versions, made of aluminum and with an opal polycarbonate diffuser. They emit direct (1L) or indirect (1L) light, or both (2L).

Available in various finishes: matte grey, satin white, satin black, or oak laminate.





MARC DOS S (1L - 2L)

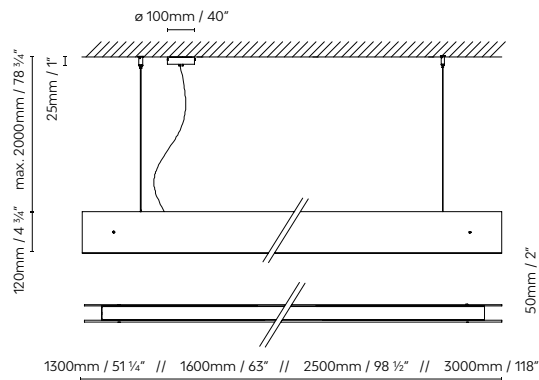

Grey (matte)
 White (matte)
 Black (satin)
 Oak

841350D	MARC DOS S130 (1L) LED DIM GREY	LED 20,5W 3536lm
841351D	MARC DOS S130 (1L) LED DIM WHITE	450mA 3000K
841352D	MARC DOS S130 (1L) LED DIM BLACK	CRI≥90 110-277V
841353D	MARC DOS S130 (1L) LED DIM OAK	DIM 1-10V

841355D	MARC DOS S130 (2L) LED DIM GREY	LED 2 x 20,5W
841356D	MARC DOS S130 (2L) LED DIM WHITE	7072lm 450mA
841357D	MARC DOS S130 (2L) LED DIM BLACK	3000K CRI≥90
841358D	MARC DOS S130 (2L) LED DIM OAK	110-277V DIM 1-10V

841360D	MARC DOS S160 (1L) LED DIM GREY	LED 25,4W 4420lm
841361D	MARC DOS S160 (1L) LED DIM WHITE	450mA 3000K
841362D	MARC DOS S160 (1L) LED DIM BLACK	CRI≥90 110-277V
841363D	MARC DOS S160 (1L) LED DIM OAK	DIM 1-10V

841365D	MARC DOS S160 (2L) LED DIM GREY	LED 2 x 25,4W
841366D	MARC DOS S160 (2L) LED DIM WHITE	8840lm 450mA
841367D	MARC DOS S160 (2L) LED DIM BLACK	3000K CRI≥90
841368D	MARC DOS S160 (2L) LED DIM OAK	110-277V DIM 1-10V

841370D	MARC DOS S250 (1L) LED DIM GREY	LED 43,2W 7514lm
841371D	MARC DOS S250 (1L) LED DIM WHITE	450mA 3000K
841372D	MARC DOS S250 (1L) LED DIM BLACK	CRI≥90 110-277V
841373D	MARC DOS S250 (1L) LED DIM OAK	DIM 1-10V

841375D	MARC DOS S250 (2L) LED DIM GREY	LED 2 x 43,2W
841376D	MARC DOS S250 (2L) LED DIM WHITE	15028lm 450mA
841377D	MARC DOS S250 (2L) LED DIM BLACK	3000K CRI≥90
841378D	MARC DOS S250 (2L) LED DIM OAK	110-277V DIM 1-10V

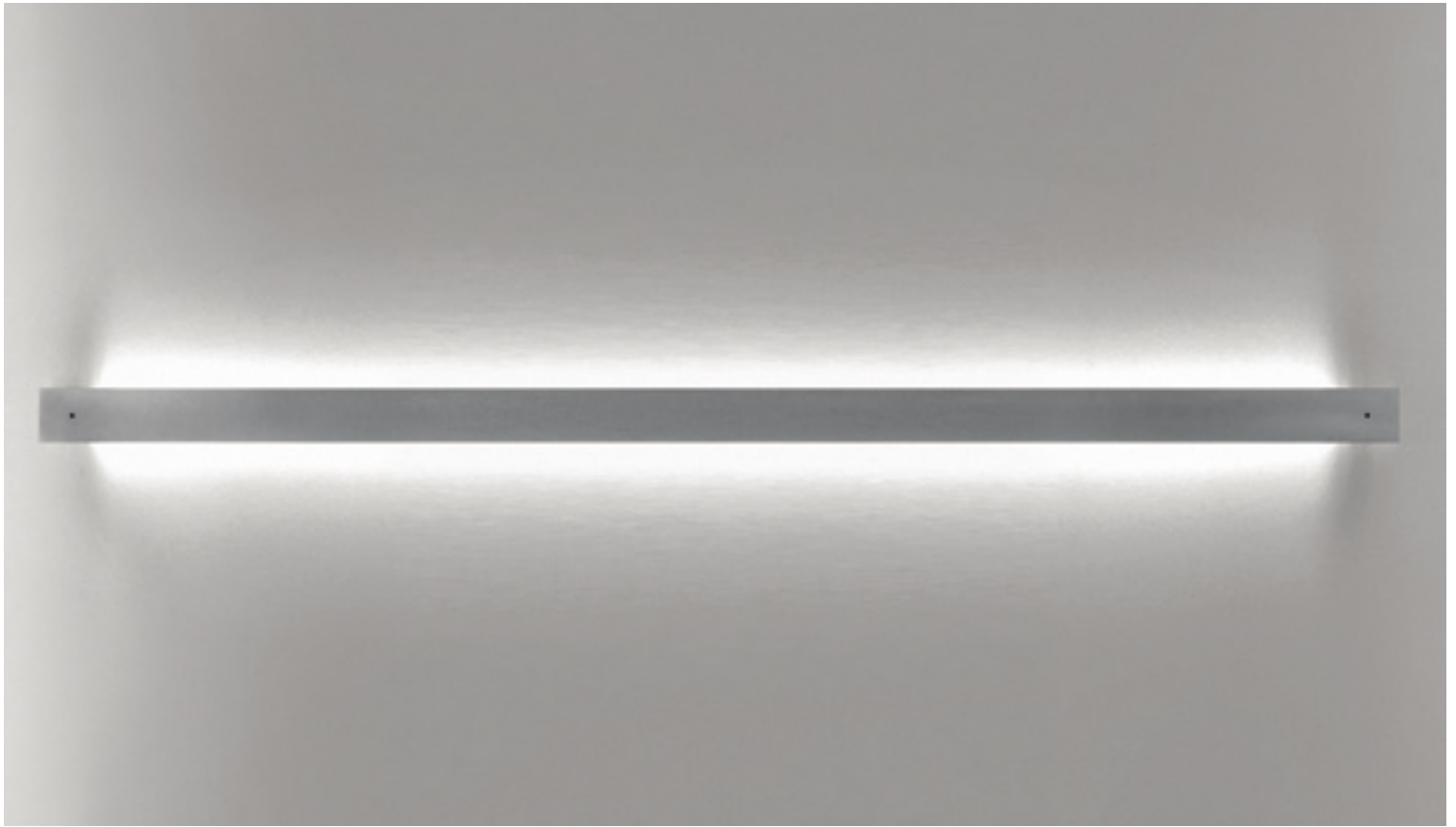

MARC DOS W (1L - 2L)

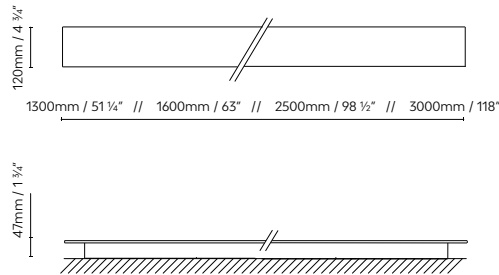

- Grey (matte)
- White (matte)
- Black (satin)
- Oak

841160D	MARC DOS W130 (1L) LED DIM GREY	LED 20,5W 3536lm
841161D	MARC DOS W130 (1L) LED DIM WHITE	450mA 3000K
841162D	MARC DOS W130 (1L) LED DIM BLACK	CRI≥90 110-277V
841163D	MARC DOS W130 (1L) LED DIM OAK	DIM 1-10V
841165D	MARC DOS W130 (2L) LED DIM GREY	LED 2 x 20,5W
841166D	MARC DOS W130 (2L) LED DIM WHITE	7072lm 450mA
841167D	MARC DOS W130 (2L) LED DIM BLACK	3000K CRI≥90
841168D	MARC DOS W130 (2L) LED DIM OAK	110-277V DIM 1-10V
841170D	MARC DOS W160 (1L) LED DIM GREY	LED 25,4W 4420lm
841171D	MARC DOS W160 (1L) LED DIM WHITE	450mA 3000K
841172D	MARC DOS W160 (1L) LED DIM BLACK	CRI≥90 110-277V
841173D	MARC DOS W160 (1L) LED DIM OAK	DIM 1-10V

841175D	MARC DOS W160 (2L) LED DIM GREY	LED 2 x 25,4W
841176D	MARC DOS W160 (2L) LED DIM WHITE	8840lm 450mA
841177D	MARC DOS W160 (2L) LED DIM BLACK	3000K CRI≥90
841178D	MARC DOS W160 (2L) LED DIM OAK	110-277V DIM 1-10V
841150D	MARC DOS W250 (1L) LED DIM GREY	LED 43,2W 7514lm
841151D	MARC DOS W250 (1L) LED DIM WHITE	450mA 3000K
841152D	MARC DOS W250 (1L) LED DIM BLACK	CRI≥90 110-277V
841153D	MARC DOS W250 (1L) LED DIM OAK	DIM 1-10V
841155D	MARC DOS W250 (2L) LED DIM GREY	LED 2 x 43,2W
841156D	MARC DOS W250 (2L) LED DIM WHITE	15028lm 450mA
841157D	MARC DOS W250 (2L) LED DIM BLACK	3000K CRI≥90
841158D	MARC DOS W250 (2L) LED DIM OAK	110-277V DIM 1-10V



B.lux

Outdoor lighting

B.lux

AMS

by
David Abad

Outdoor
lighting

Range of outdoor lamps with geometric forms, available in three sizes. Made from corten steel or 316L stainless steel.





AMS 12

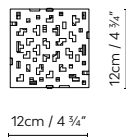
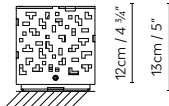

AMS 20

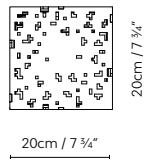
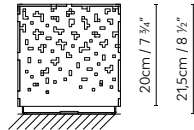

AMS 40

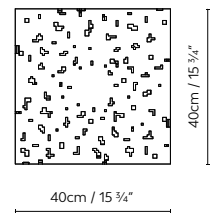
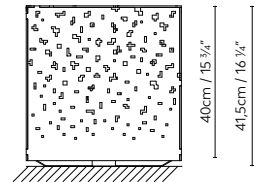

● Corten steel ● Stainless steel 316L

712220U	AMS 12 CORTEN	LED 5W (E12) / Fluo. CFL 8W (E12) / Inc. max. 40W (E12)
712221U	AMS 12 INOX	
712200U	AMS 20 CORTEN	LED 11W (E26) / Fluo. CFL 18W (E26) / Inc. max. 75W (E26)
712201U	AMS 20 INOX	
712210U	AMS 40 CORTEN	LED 13W (E26) / Fluo. CFL 26W (E26) / Inc. max. 100W (E26)
712211U	AMS 40 INOX	



B.lux

Frame

by
Mario Ruiz

**Outdoor
lighting**

An outdoor low level feature luminaire in the shape of a hollow rectangular prism with rounded edges. The structure is made from aluminum and the diffuser is made from pressed glass. This light fitting will intensely illuminate the interior hollow and softly and asymmetrically illuminate the surrounding area. Frame is available in three different sizes: S, M and L. Finishes: Satin white, texturised bronze, forged grey, corten-finish.



Frame





FRAME S

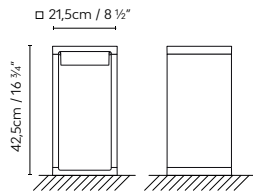

FRAME M

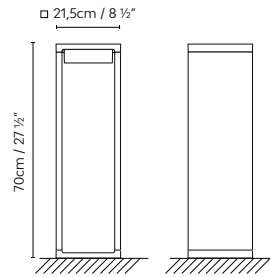

FRAME L

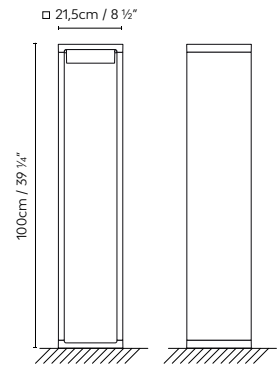

○ White (satin) ● Bronze ● Grey (forged) ● Corten

677220U	FRAME S FLUO WHITE	Fluo. 2 x 7W (2G7)
677223U	FRAME S FLUO BRONZE	
677226U	FRAME S FLUO GREY	
677241U	FRAME S FLUO CORTEN	
677221U	FRAME M FLUO WHITE	Fluo. 2 x 7W (2G7)
677224U	FRAME M FLUO BRONZE	
677227U	FRAME M FLUO GREY	
677243U	FRAME M FLUO CORTEN	
677222U	FRAME L FLUO WHITE	Fluo. 2 x 7W (2G7)
677225U	FRAME L FLUO BRONZE	
677228U	FRAME L FLUO GREY	
677245U	FRAME L FLUO CORTEN	



B.lux

Inn Side

by
Gemma Bernal

**Outdoor
lighting**

Portable indoor and outdoor lamp crafted of plain vandal-proof and UVA-resistant opal white PE. Radiata wood featuring a stabilizing treatment to prevent warping. 3.5-meter cable.



INN SIDE

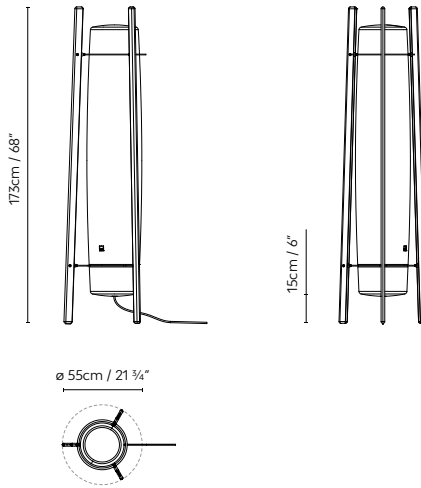

● ○ Radiata / Opal white

730200U	INN SIDE LED	LED 4 x 16W 11072lm 350mA 3000K CRI≥90 120V
730210U	INN SIDE FLUO	Fluo. 2 x 28W (G5) / LED 2 x 17W (G5)



B.lux

Kanpazar

by
Jon Santacoloma

**Outdoor
lighting**

Indoor and outdoor lamps, in a smooth opal white finish, made from vandal Proof. UV resistant polyethylene. Available in two sizes: 150 cm and 80 cm, and different versions. Kanpazar A is fixed to the ground and hard wired, while Kanpazar B is portable and has a maximum wiring connection of 3.5 meters. Kanpazar C, which has a concrete base, is portable and has a maximum wiring connection of 3,5 meters. Kanpazar 150 is also available in an additional version D made from a stainless steel base that is secured to the ground with the connection provided.





KANPAZAR 80A

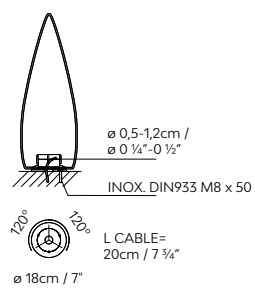
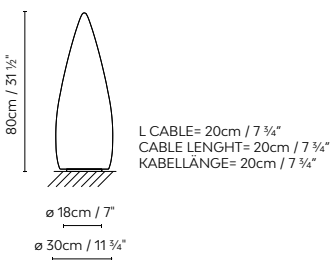

KANPAZAR 80B

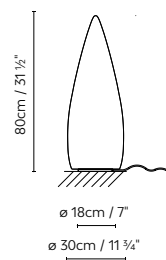

KANPAZAR 80C

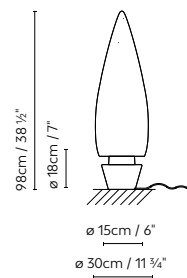

KANPAZAR 150A

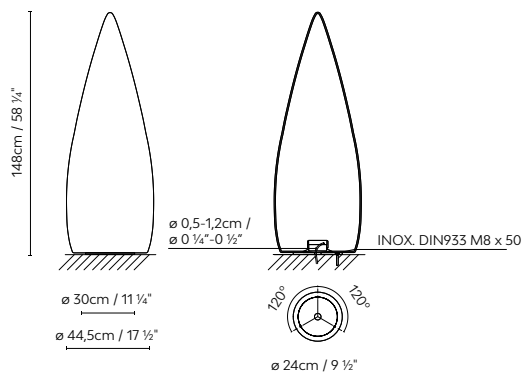

KANPAZAR 150B

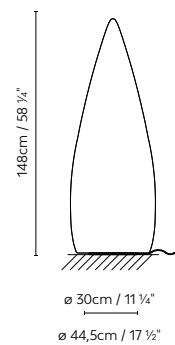

KANPAZAR 150C

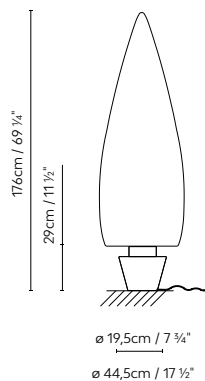

KANPAZAR 150D

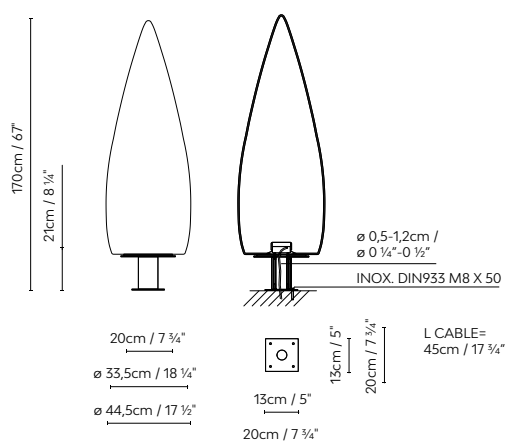

○ Opal white

659250U	KANPAZAR 150A LED	LED 4 x 12W 8304lm 350mA 3000K CRI≥90 120V
659200U	KANPAZAR 150A FLUO 2G11	Fluo. 2 x 55W (2G11)
659210U	KANPAZAR 150A G5	Fluo. 2 x 21W (G5) / LED 2 x 10W (G5)
659251U	KANPAZAR 150B LED	LED 4 x 12W 8304lm 350mA 3000K CRI≥90 120V
659201U	KANPAZAR 150B FLUO 2G11	Fluo. 2 x 55W (2G11)
659211U	KANPAZAR 150B G5	Fluo. 2 x 21W (G5) / LED 2 x 10W (G5)
659252U	KANPAZAR 150C LED	LED 4 x 12W 8304lm 350mA 3000K CRI≥90 120V
659202U	KANPAZAR 150C FLUO 2G11	Fluo. 2 x 55W (2G11)
659212U	KANPAZAR 150C G5	Fluo. 2 x 21W (G5) / LED 2 x 10W (G5)

659254U	KANPAZAR 150D LED	LED 4 x 12W 8304lm 350mA 3000K CRI≥90 120V
659204U	KANPAZAR 150D FLUO 2G11	Fluo. 2 x 55W (2G11)
659214U	KANPAZAR 150D G5	Fluo. 2 x 21W (G5) / LED 2 x 10W (G5)
659270U	KANPAZAR 80A LED	LED 4 x 6W 4152lm 350mA 3000K CRI≥90 120V
659220U	KANPAZAR 80A FLUO	Fluo. 2 x 36W (2G11)
659271U	KANPAZAR 80B LED	LED 4 x 6W 4152lm 350mA 3000K CRI≥90 120V
659221U	KANPAZAR 80B FLUO	Fluo. 2 x 36W (2G11)
659272U	KANPAZAR 80C LED	LED 4 x 6W 4152lm 350mA 3000K CRI≥90 120V
659222U	KANPAZAR 80C FLUO	Fluo. 2 x 36W (2G11)

B.lux

Speers Outdoor

by
David Abad

Outdoor
lighting

Outdoor lighting system consisting of one or more LED light sources with a solid black or white matte finish that can be installed with different accessories to yield various applications. F Accessory can be used to create a portable floor lamp with a 2.5-metre cable. This accessory also features a cylindrical concrete base and a matte black metal bar where up to three heads can be installed. Speers Outdoor can also be installed as a ceiling (C Accessory), wall (W Accessory), and angled wall (Angle Accessory) lamp thanks to the matte black metal bars that measure 120 and 150 cm long. These accessories can be combined to create custom layouts in any outdoor area.



Speers Outdoor



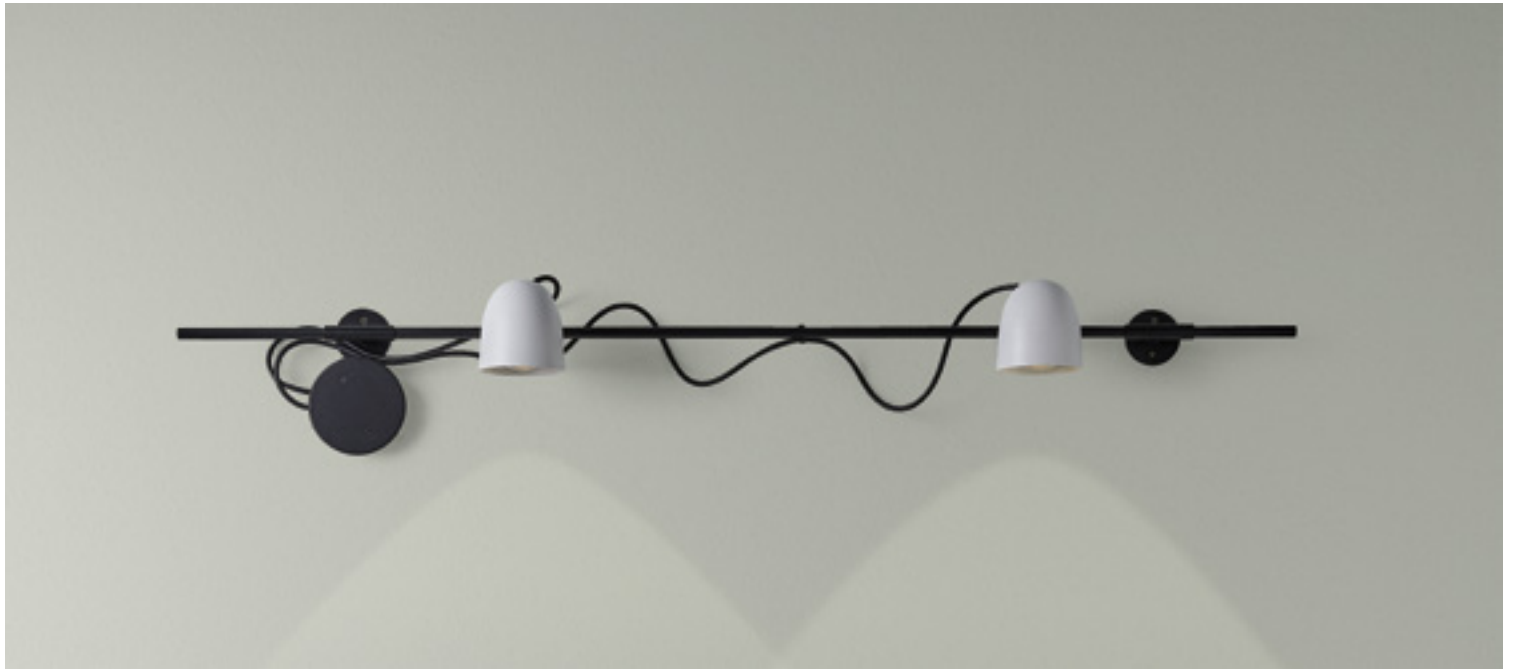

SPEERS OUTDOOR LIGHT SOURCE

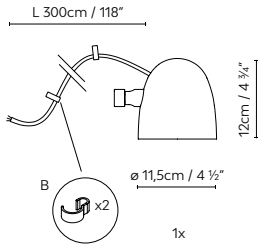

SPEERS OUTDOOR F ACCESSORY

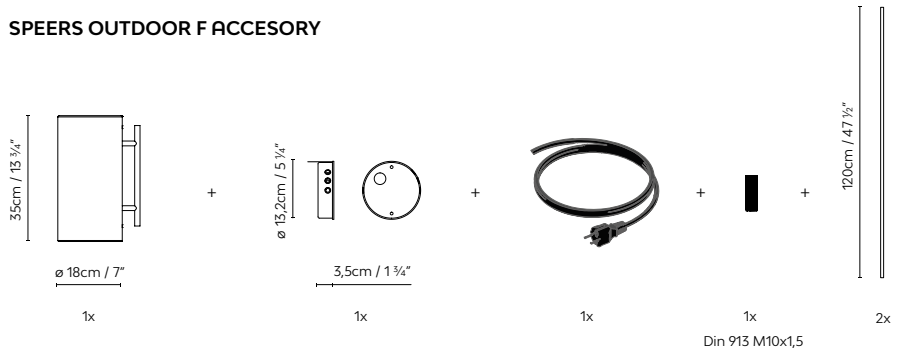

SPEERS OUTDOOR C ACCESSORY

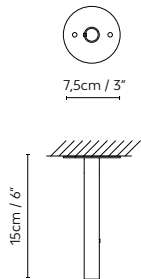

SPEERS OUTDOOR ANGLE ACCESSORY (2X)

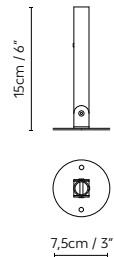

SPEERS OUTDOOR W ACCESSORY

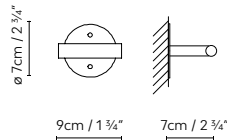

SPEERS OUTDOOR STEM ACCESSORY 120/150

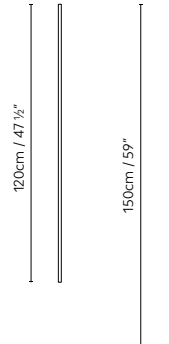

SPEERS OUTDOOR CONNECTION BOX

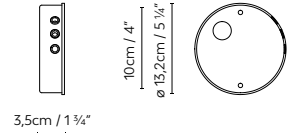

● Black (matte) ○ White (matte)

753000U **SPEERS OUTDOOR LIGHT SOURCE BLACK** LED 7W 520lm
 753001U **SPEERS OUTDOOR LIGHT SOURCE WHITE** 2700K CRI≥90 120V

753200U **SPEERS OUTDOOR F ACCESSORY**
 753110U **SPEERS OUTDOOR W ACCESSORY**
 753130U **SPEERS OUTDOOR ANGLE ACCESSORY**
 753400U **SPEERS OUTDOOR C ACCESSORY**
 753900U **SPEERS OUTDOOR CONNECTION BOX**
 753920U **SPEERS OUTDOOR STEM ACCESSORY 120**
 753930U **SPEERS OUTDOOR STEM ACCESSORY 150**



B.lux

Speers Outdoor W1 / Bollard

by
David Abad

Outdoor
lighting

Outdoor LED lamps available for wall (Speers Outdoor W1) or bollard (Speers Outdoor Bollard). The wall lamp gives adjustable direct light and is sold in solid matte white and matte black. The bollard model is made in metal with a matte black finish. Both the wall and bollard models are equipped with a LED light source with a glass lens that focuses the light and enhances its luminous efficiency.



Speers Outdoor W1 / Bollard



SPEERS OUTDOOR W1

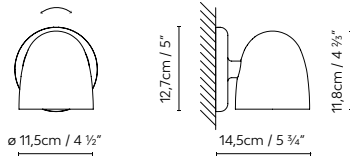

SPEERS OUTDOOR BOLLARD

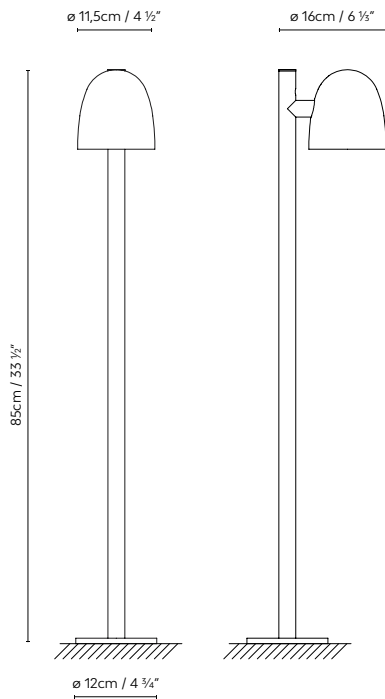

● Black (matte) ○ White (matte)

753122U **SPEERS OUTDOOR W1 BLACK** LED 7W 520lm 2700K CRI≥90 120V
 753121U **SPEERS OUTDOOR W1 WHITE**

753212U **SPEERS OUTDOOR BOLLARD BLACK** LED 7W 520lm 2700K CRI≥90 120V
 753211U **SPEERS OUTDOOR BOLLARD WHITE**



B.lux





Iconography



Suspension lamp



Floor lamp



Table lamp



Wall lamp



Ceiling lamp



Lighting systems



Degree of protection 20



Degree of protection 44



Degree of protection 54



Degree of protection 55



Degree of protection 65



Programme for the Endorsement of Forest Certification



Class I



Class II



Class III



European norm



EAC certification



ENEC certification



N certification



Dimmer



Bluetooth

REQUEST



UL certification



UL certification



Americans with Disabilities Act



REQUEST

CASAMBI B.lux powered by Casambi App

The Casambi app works as one of the user interfaces in a Casambi lighting control solution, as the commissioning tool and as well as a remote gateway. The Casambi app works with iOS as well as Android devices, like smartphones, tablets and smartwatches. The app is free to download by any end-user.

The Casambi app is made by user interface experts and in a way, that anyone – regardless of technical proficiency – can use it. The Casambi lighting control technology gives a possibility for Casambi's partners to implement and develop anything needed for a full-featured lighting control system, but the Casambi app only shows in the user interface the functionality that is relevant to that particular installation. Therefore, the Casambi app is equally well suitable for the professional lighting market as well as the residential field.

For US Distribution, please contact IM Design Concepts
imdesignconcepts.com | info@imdesignconcepts.com | (813) 284-7435

B.LUX S.A.

Pol. Ind. Okamika, pab. 1
Gizaburuaga (Bizkaia) SPAIN
T. (+34) 94 682 72 72
F. (+34) 94 682 49 02
info@grupoblux.us
www.grupoblux.us

Showroom

183 Madison Ave.
Suite 1718
NEW YORK, NY 10016
T. (1) 929 277 9524
usa@grupoblux.com

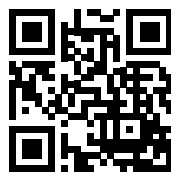

DEPÓSITO LEGAL

B.lux S.A. reserves the right to make any modifications and remove products and their technical characteristics without prior notice.

B.lux

Proudly Distributed by

IMDC
IM DESIGN CONCEPTS

B.lux

grupoblux.us