

Catalogue

lambert&fils

Sainte Collection - Classic	3
Sainte Collection - Atelier	11
Parc Collection	19
Hutchison Collection	27
Dorval Collection	35
Mile Collection	43
Laurent Collection	61
Clark Collection	77
Beaubien Collection	85
Cliff Collection	99
Dot Collection	113
Waldorf Collection	133



Sainte Collection - Classic

Featuring lightweight glass, slight dimensions and subdued colours, the Sainte's Classic series is destined for residential and office interiors—invoking magic and theatre into accessible designs. Hung solo or in multiples, Sainte's tones and textures unearth ambiance and imbue a sense of intimacy. Created in collaboration with Canadian designer Rachel Bussin.





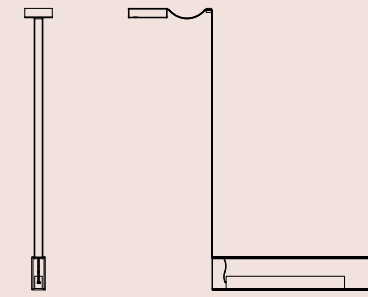
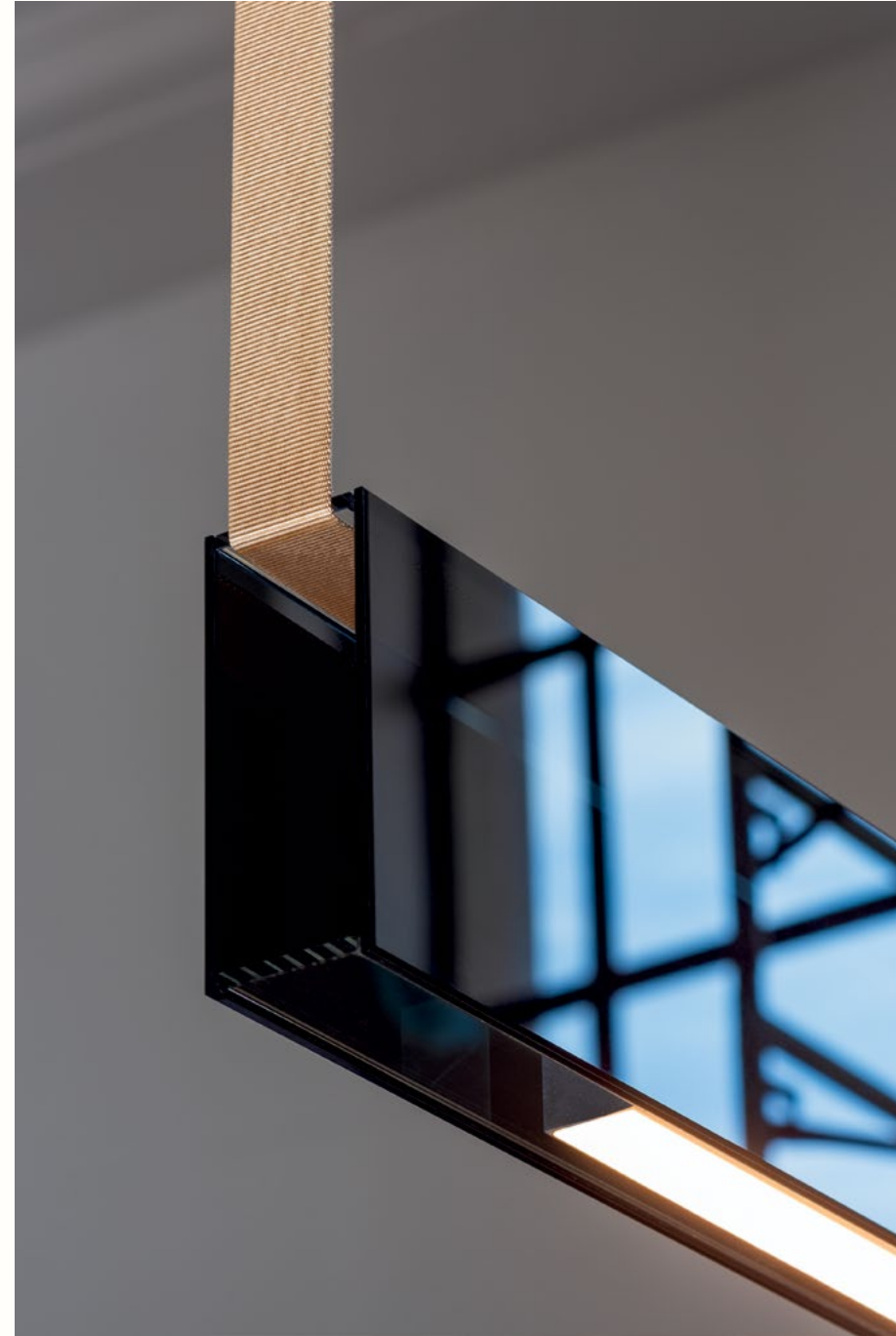

Sainte 01

L 30 x W 2 x H 6 in
L 760 x W 50 x H 150 mm
Total height variable

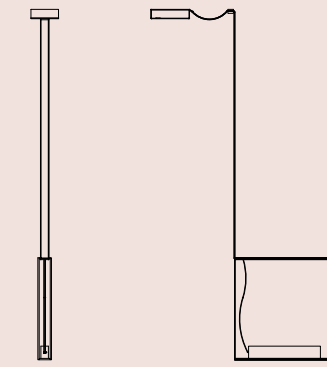

Sainte 02

L 18.5 x W 2 x H 18.5 in
L 470 x W 50 x H 470 mm
Total height variable

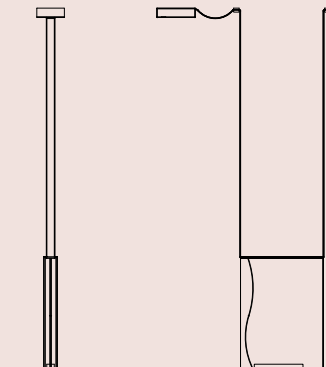

Sainte 03

L 15 x W 2 x H 22 in
L 380 x W 50 x H 560 mm
Total height variable

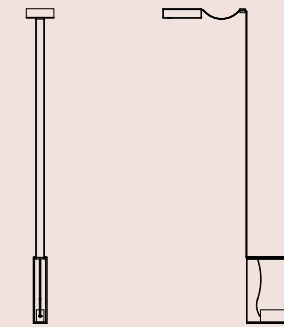

Sainte 04

L 8 x W 2 x H 12 in
L 200 x W 50 x H 305 mm
Total height variable

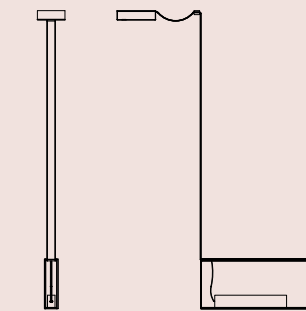

Sainte 05

L 22.5 x W 2 x H 9 in
L 570 x W 50 x H 230 mm
Total height variable

All Sainte Classic Models

Finishes : Black / Bronze / Extra Clear /
Frosted Extra Clear / Frosted Grey /
Green / Grey

Nylon ribbon : Beige or Black

Materials : Aluminum polished light block and
ceiling anchors, Float glass body,
Nylon ribbon, PMMA frosted diffuser

LED array, dimmable
120-277V / 220-240V





Sainte Collection - Atelier

Sainte's Atelier Series is scaled for large spaces and higher ceilings—composed of boldly hued laminated glass panels with pronounced presence and weight. The dynamic colour options for this series harken a sense of majesty: lighting that creates a spectacle, that becomes a monument. A collaboration with Canadian designer Rachel Bussin.





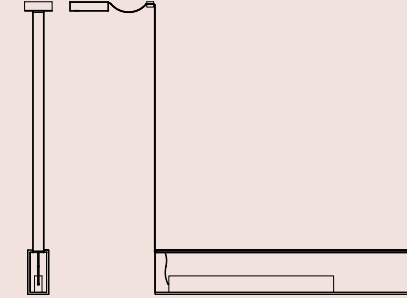

Sainte 06
 L 48 x W 3.8 x H 8 in
 L 1220 x W 96 x H 203 mm
 Total height variable

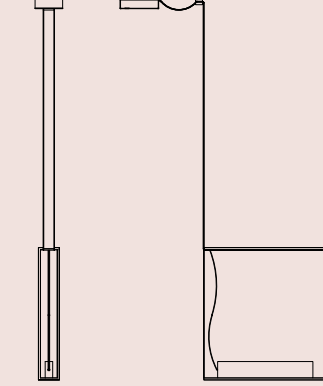

Sainte 07
 L 24 x W 3.8 x H 24 in
 L 610 x W 96 x H 610 mm
 Total height variable

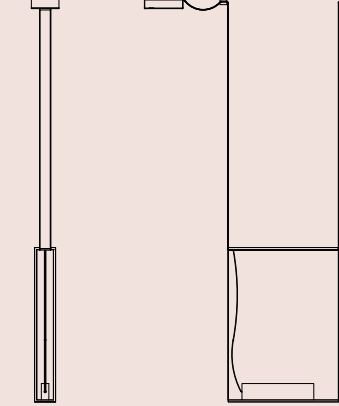

Sainte 08
 L 20 x W 3.8 x H 28 in
 L 510 x W 96 x H 710 mm
 Total height variable

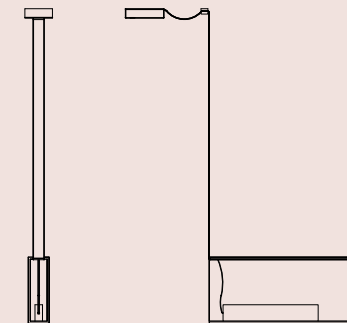

Sainte 09
 L 27 x W 3.8 x H 12 in
 L 686 x W 96 x H 305 mm
 Total height variable

All Sainte Atelier Models

Finishes : Yellow + Dark yellow / Green /
 Medium grey / Dark red + Frosted blush /
 Light peach + Frosted grey

Materials : Aluminum polished light block and
 ceiling anchors, Laminated glass body,
 Nylon ribbon, PMMA frosted diffuser

LED array, dimmable
 120-277V / 220-240V





Parc Collection

Parc is a collection inspired by childhood imagination and the essentiality of homemade forms—created in collaboration with Swiss designer Adrien Rovero. Evoking the archetype of a flashlight, each lamp of the Parc Collection is a playful reminder of time spent in nature, when a simple tube and piece of string could be used to fashion any number of creations. These makeshift things, at once naive and functional, harness the unique beauty of peeling an object back to its essence.



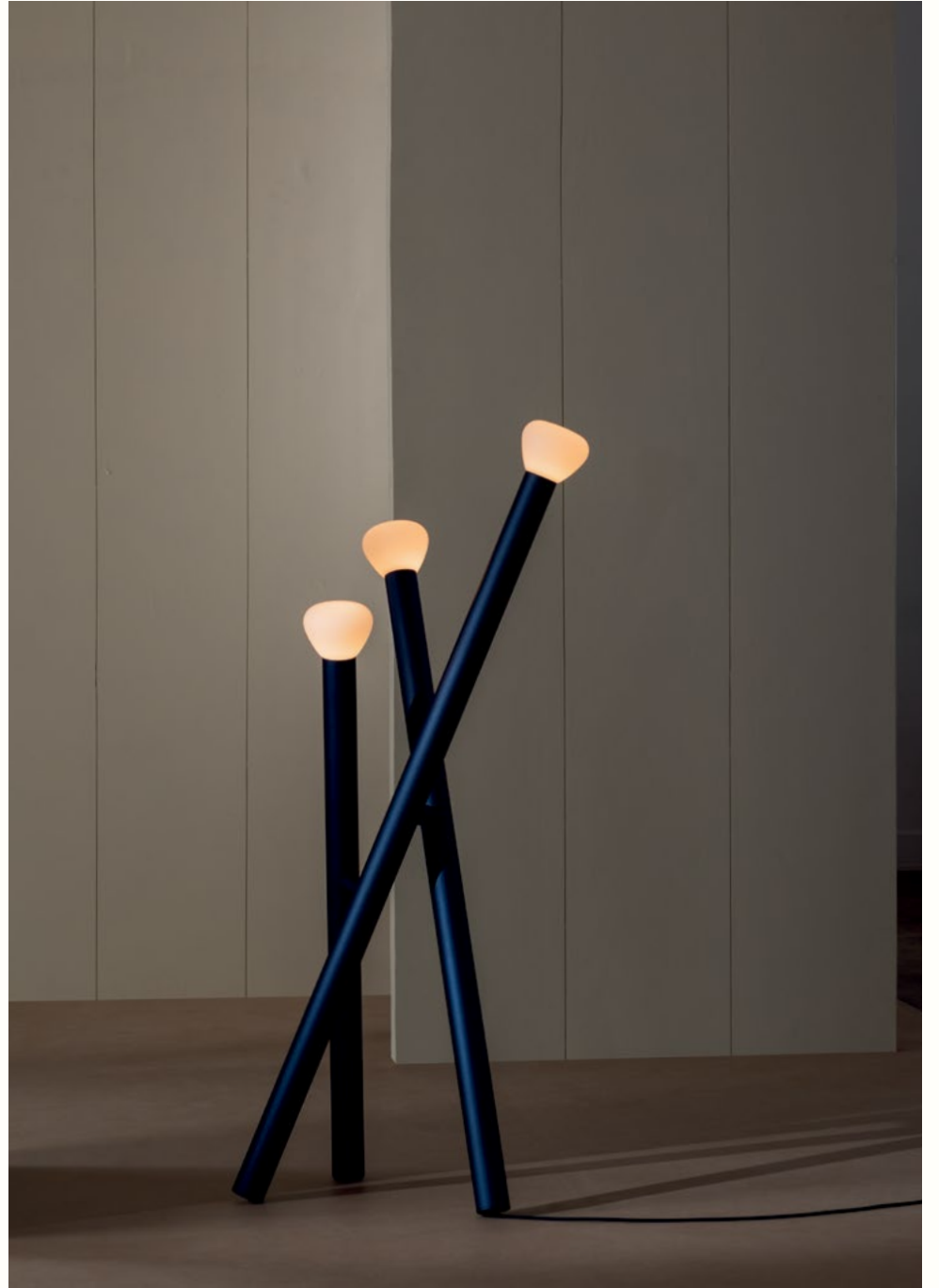

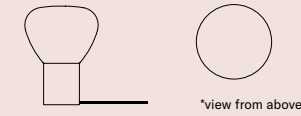

Parc 01
 ø 5 x H 6.8 in
 ø 130 x H 170 mm

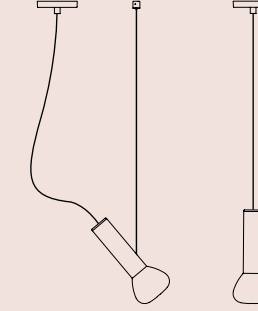

Parc 02
 L 5 x W 5 x H 12 in
 L 130 x W 130 x H 302 mm
 Total height variable

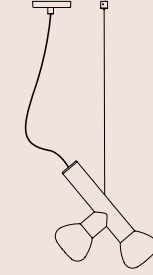

Parc 03
 L 5 x W 8.6 x H 15.4 in
 L 130 x W 218 x H 390 mm
 Total height variable

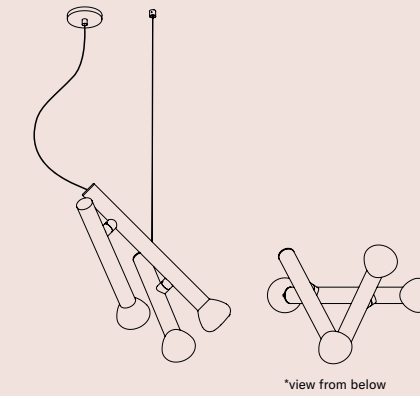

Parc 04
 L 24.25 x W 20 x H 29 in
 L 616 x W 508 x H 740 mm

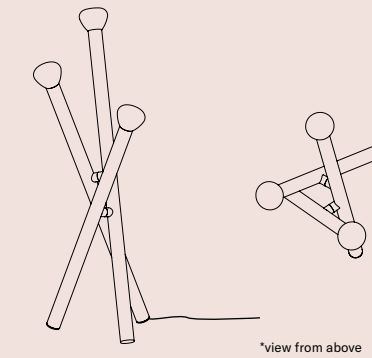

Parc 05
 L 31 x W 23 x H 59 in
 L 787 x W 584 x H 1500 mm

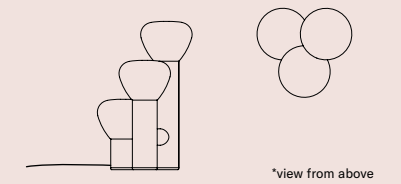

Parc 06
 L 9 x W 9 x H 18 in
 L 230 x W 230 x H 460 mm

All Parc Models

Finishes : Beige / Black / Blue / Burgundy / Green /
 Midnight blue / Terracotta / White
 Materials : Hand blown frosted glass, Powder coated
 aluminum body, Polyester cord
 G9 LED bulb, dimmable
 120V / 240 V



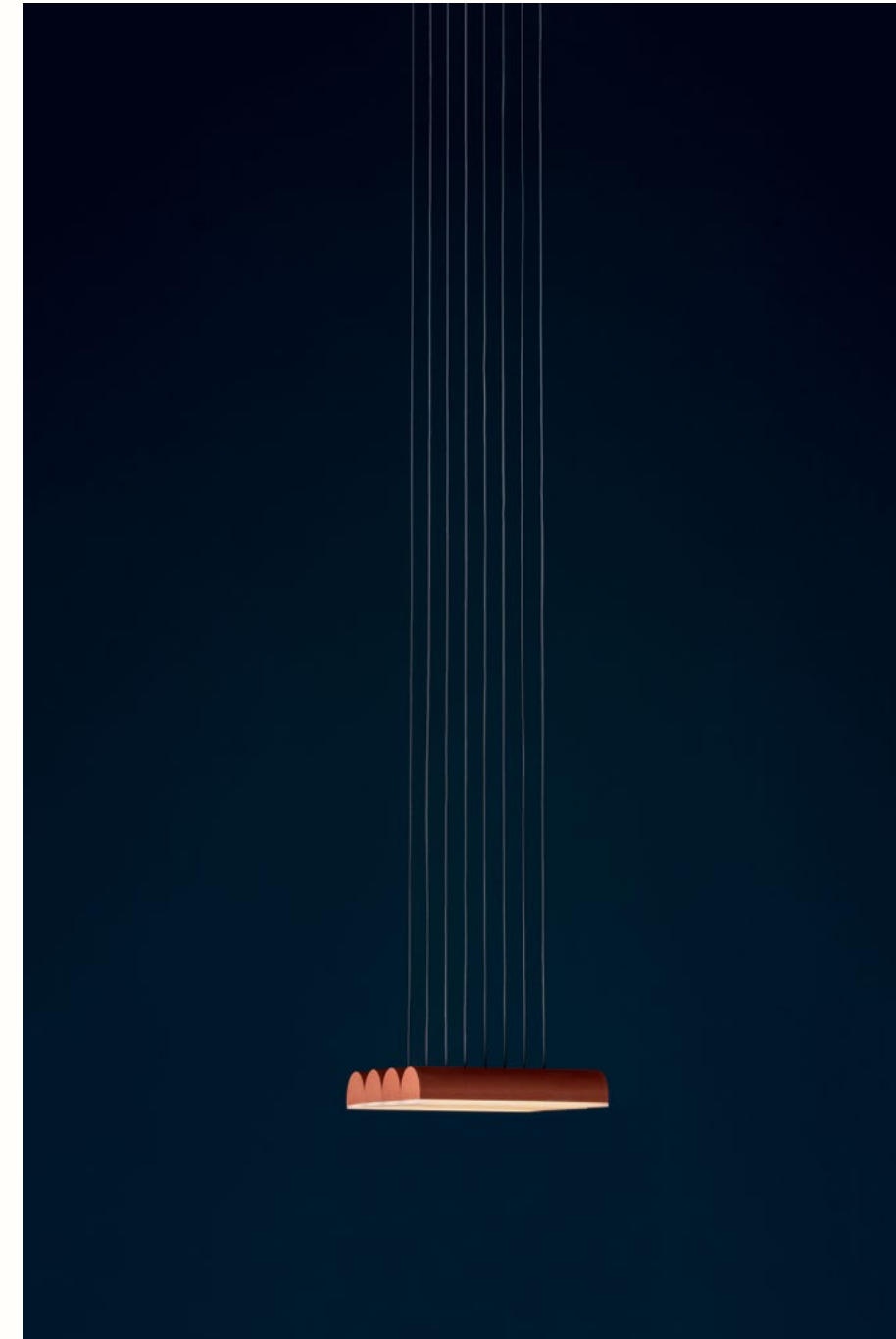

Hutchison Collection

Hutchison is the thoughtful study of soft curves and hard lines—a rivalry of vertical and horizontal forces and a play of scale and repetition. Alone, it self-defines as a frank, decorative pendant light. In multiples, it evokes the iconic patterns of Middle Eastern archways and Roman terracotta roofs.

Each lamp is composed of an aluminum base with a textured, matte finish. Prominent suspension wires made from waxed cotton contrast the dense horizontal base—an interplay of mass and lightness, stirring a collective memory of archetypal forms.





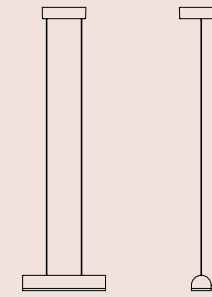

Hutchison 01

L 9.5 x W 2.25 x H 1.7 in
 L 240 x W 60 x H 40 mm
 Total height variable

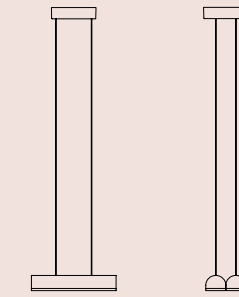

Hutchison 02

L 9.5 x W 4.5 x H 1.7 in
 L 240 x W 60 x H 40 mm
 Total height variable

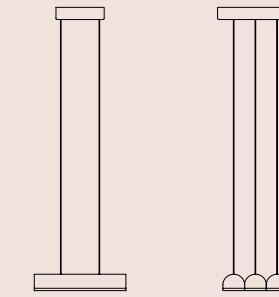

Hutchison 03

L 9.5 x W 6.8 x H 1.7 in
 L 240 x W 60 x H 40 mm
 Total height variable

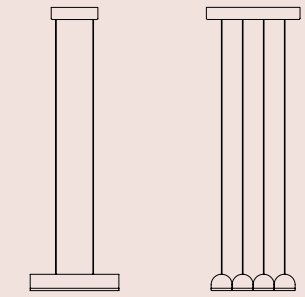

Hutchison 04

L 9.5 x W 9 x H 1.7 in
 L 240 x W 240 x H 40 mm
 Total height variable

All Hutchison Models

Finishes : Beige / Black / Polished aluminium /
 Terracotta / White
 Materials : powder-coated or polished aluminium,
 PMMA, polyester
 LED array, dimmable
 120V-277 V / 220-240V





Dorval Collection

Dorval is a lighting collection layered in history, a subtle interplay between contemporary and vintage industrial design. It is the retail-ready version of a prototype pendant originally designed by SCMP DESIGN OFFICE (Paris, France)—edited and exclusively produced in Lambert & Fils' Montreal atelier. Drawing equal inspiration from airport runway lights and the essential qualities of a chandelier, Dorval is composed of a main vertical body and four aluminium heads with LED panels. Each head can be adjusted to distribute light in any direction, while the precision of each component keeps the lamp balanced and aligned. The result is a light both confrontational and intriguing—one which poses an immediate invitation to play.

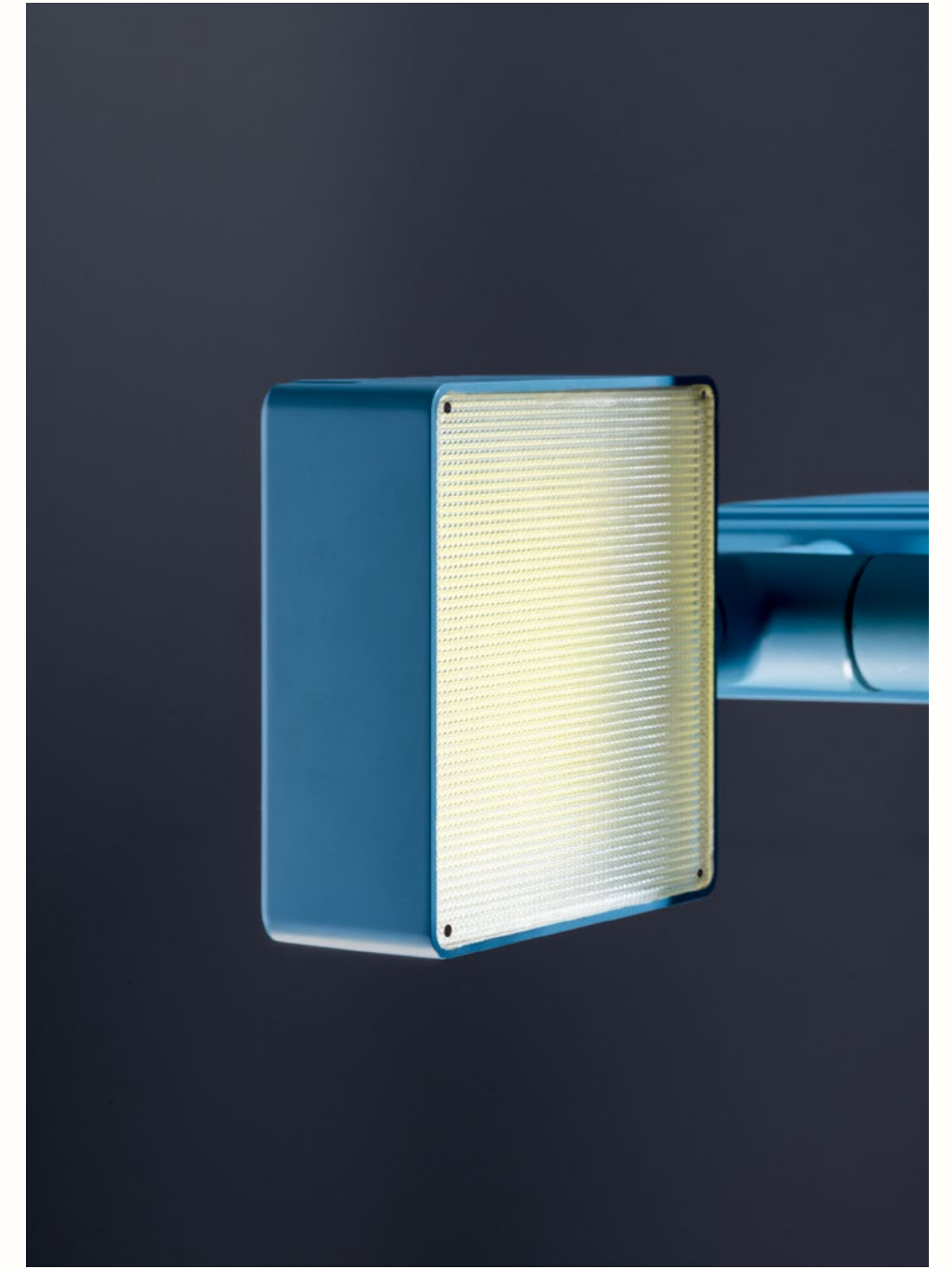



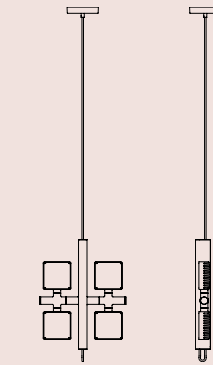

Dorval 01
L 14 x W 2.5 x H 18 in
L 356 x W 64 x H 460 mm
Height variable

Dorval Collection

Finishes : Black / Light Blue / White /
Polished aluminium

Materials : Aluminium, powder coated or
polished aluminium, PMMA, polyester

LED array, dimmable
120-277V / 220-240V





Mile Collection

A collaboration between Lambert & Fils and Guillaume Sasseville, Mile offers a variation on the linear suspension, pared down to its simplest asymmetrical expressions, with two lines floating in equilibrium. Direct and indirect light are separated by a 90° pivot, thus marking out space with light. A play on contrasts, Mile is part art installation and part utilitarian light. The use of linear LED technology and the wires clamped into the structure add to the weightless, almost levitating feel of the lamp.

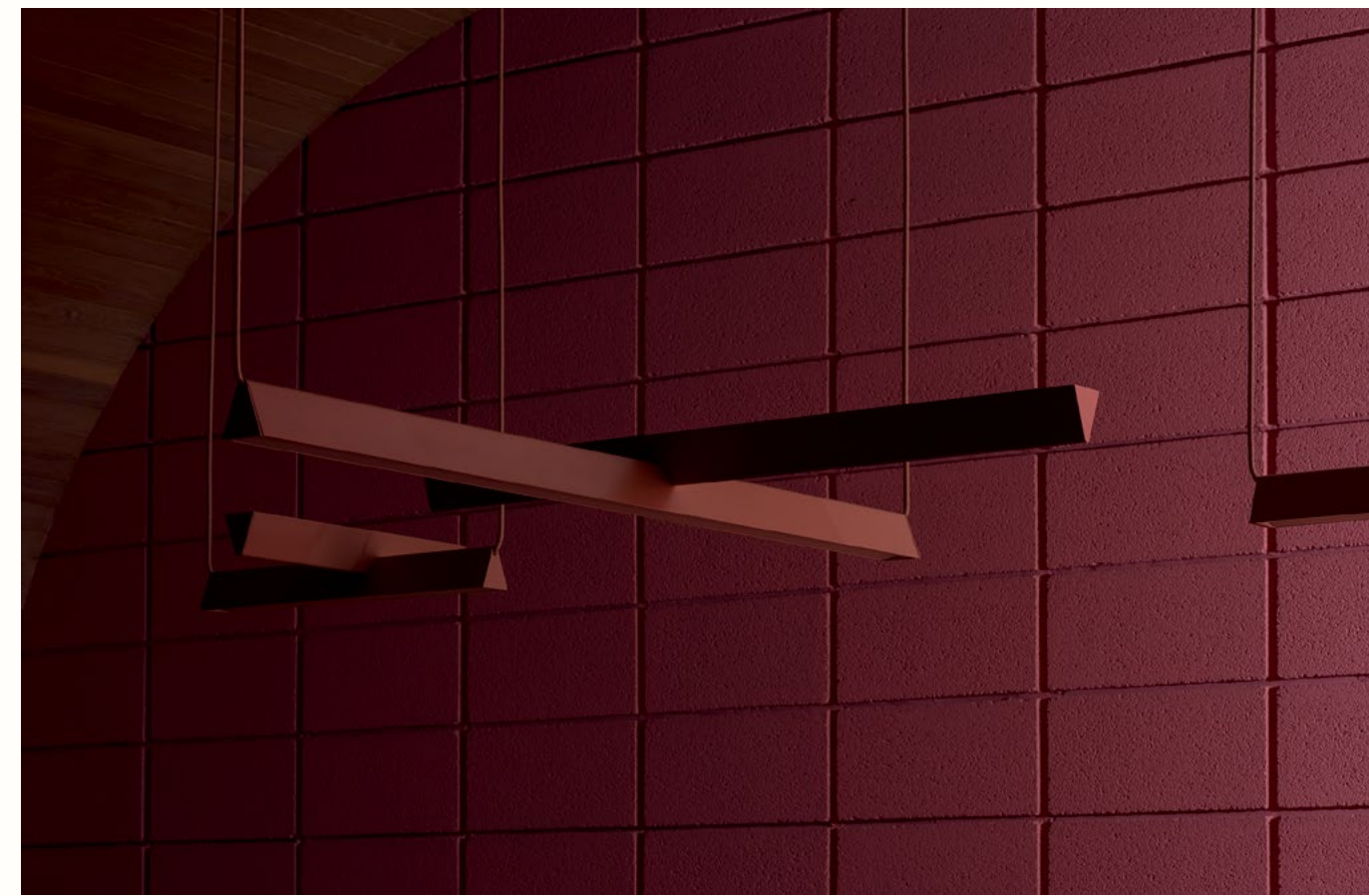

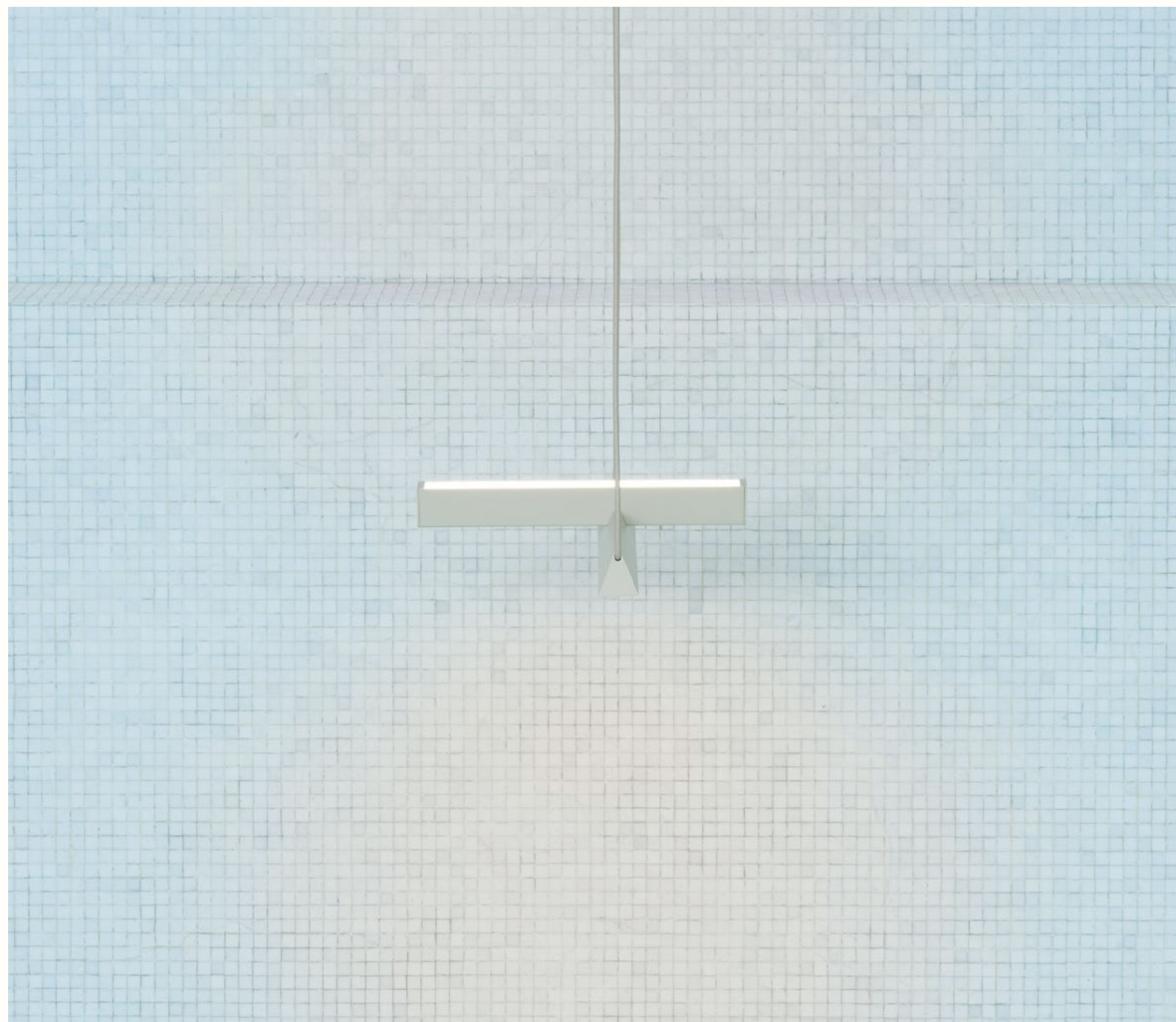









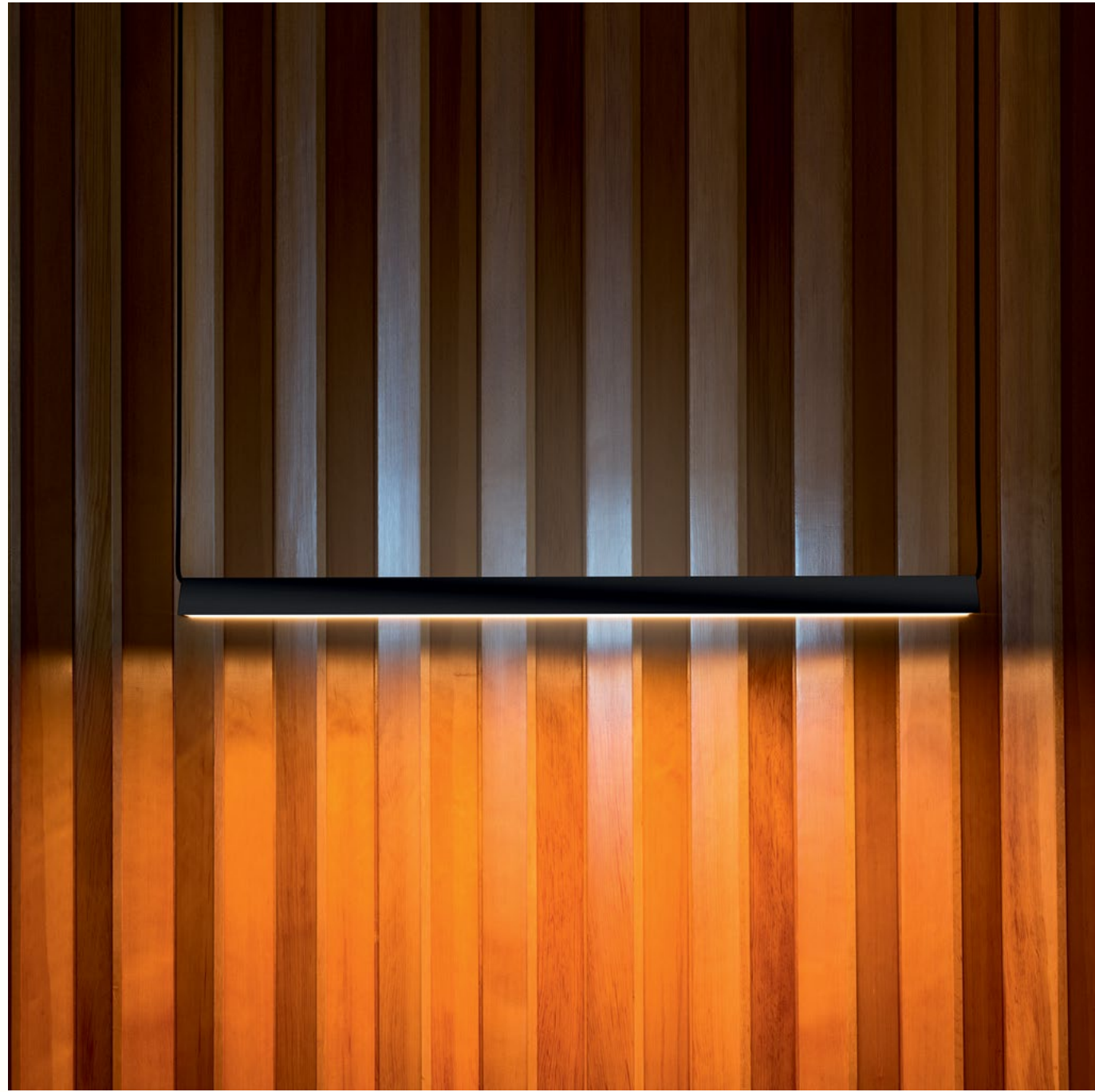

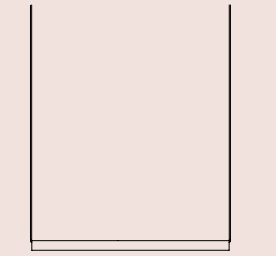
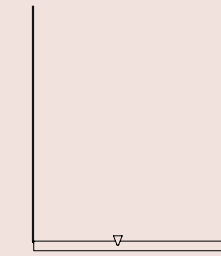
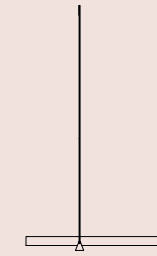
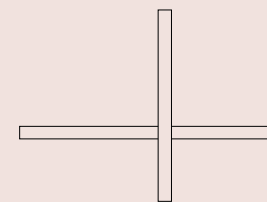
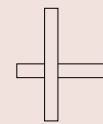
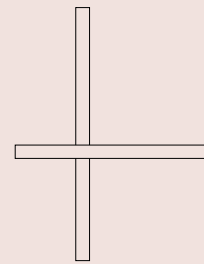
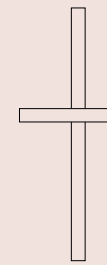
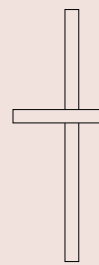
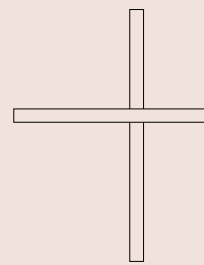
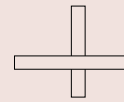
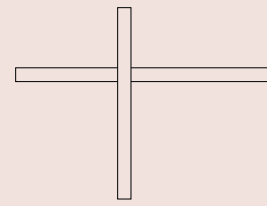

Mile 01

L 45 x W 34 x H 3.5 in
L 1150 x W 860 x H 89 mm
Total height variable

Mile 02

L 20 x W 17 x H 3.5 in
L 500 x W 430 x H 89 mm
Total height variable

Mile 03

L 45 x W 17 x H 3.5 in
L 1160 x W 430 x H 89 mm
Total height variable

Mile 04

L 45.5 (A), 68 (B) ou 79 (C) x W 2 x H 3.5 in
L 1150(A), 1730 (B) ou 2010 (C) x W 60 x H 89 mm
Total height variable

All Mile Models

Finishes : Beige / Black / Burgundy / Green /
White / Polished aluminium
Materials : Aluminium, Frosted Polycarbonate
Led array, dimmable
120V / 240V

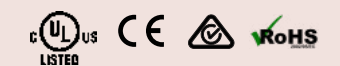



Laurent Collection

The Laurent Collection distills the milk globe to its essential relationships between circle and sphere. A series of thin forms complement the Laurent globes—forms that carve through space, moving between line, surface, and volume. These forms combine in endless patterns, making it possible for an installation of Laurent lamps to inhabit any space with subtlety and quiet strength.













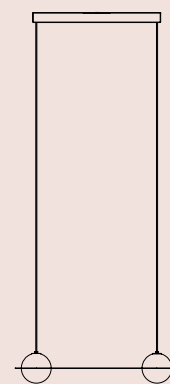
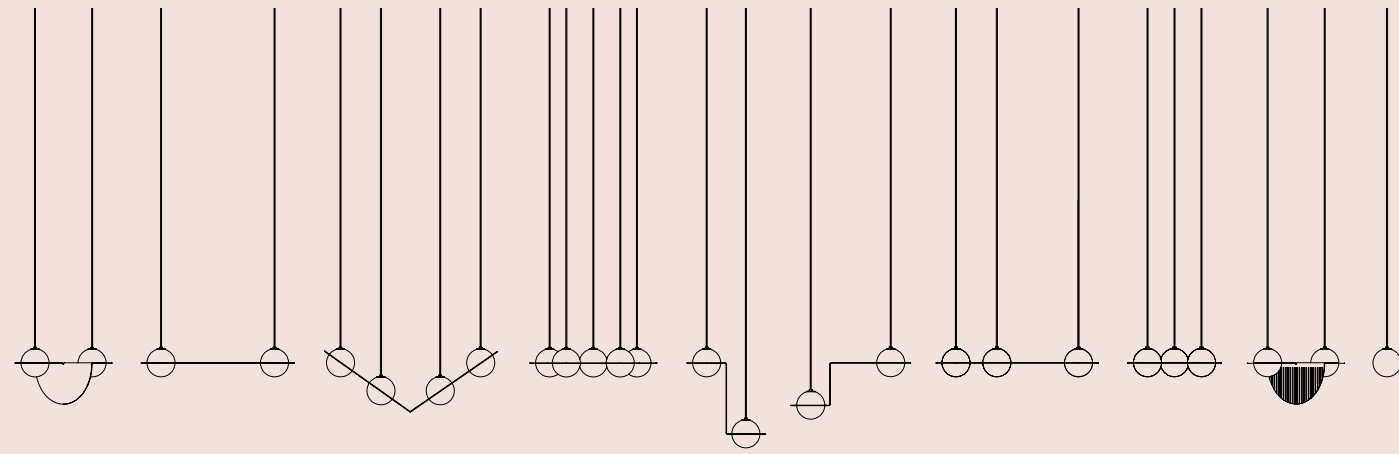

Parallel Wires

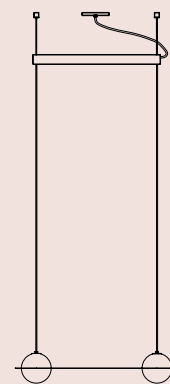

Parallel Wires with Offset Canopy

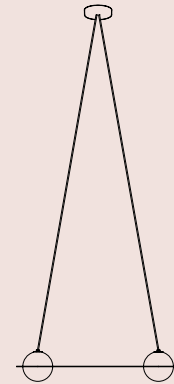

Angled Wires

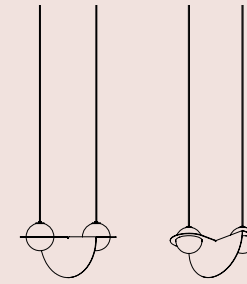

Laurent 01
L 16 x W 16 x H 11 in
L 410 x W 410 x H 280 mm
Total height variable

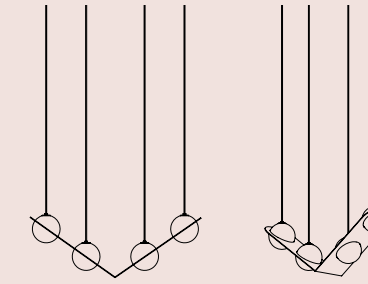

Laurent 02
L 32 x W 8 x H 13 in
L 810 x W 200 x H 330 mm
Total height variable

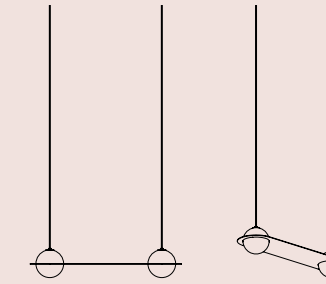

Laurent 03
L 30 x W 8 x H 5.5 in
L 760 x W 200 x H 140 mm
Total height variable

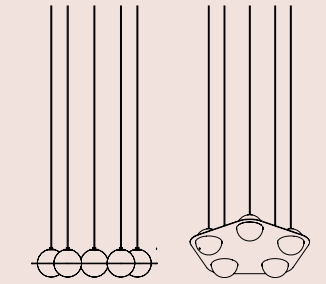

Laurent 04
L 30 x W 8 x H 5.5 in
L 760 x W 200 x H 140 mm
Total height variable

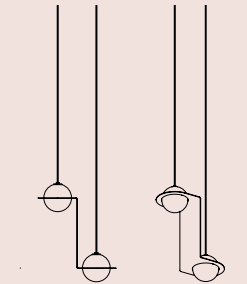

Laurent 05
L 16 x W 8 x H 20 in
L 410 x W 200 x H 510 mm
Total height variable

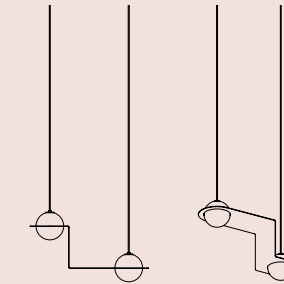

Laurent 06
L 24 x W 8 x H 14 in
L 610 x W 200 x H 360 mm
Total height variable

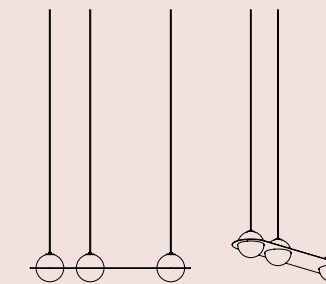

Laurent 07
L 31 x W 8 x H 5.5 in
L 790 x W 200 x H 140 mm
Total height variable

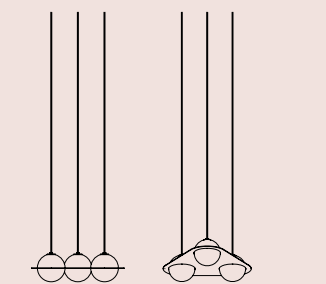

Laurent 08
L 18 x W 17 x H 5.5 in
L 460 x W 430 x H 140 mm
Total height variable

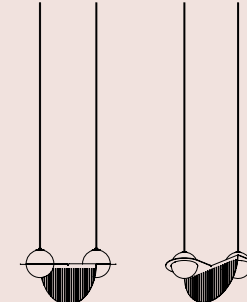

Laurent 09
L 16 x W 16 x H 11 in
L 410 x W 410 x H 280 mm
Total height variable



Laurent 10
ø 5.5 in / 360 mm
Total height variable

All Laurent Models
Finishes : Black / Brass / Nickel / Burgundy / Blue / Turquoise
Materials : Brass Steel, powder coated aluminium, Hand-blown Glass
G9 LED bulb, dimmable
120V / 240V

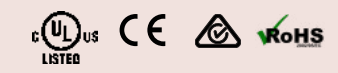



Clark Collection

The Clark Collection pushes the limits of form without sacrificing functionality. Cut and bent metal creates shades that both block and reflect the lamp's light source, casting an even wash of light on any surface. Marble is used not only to anchor the lamps, but to provide a contemporary touch to its surrounding environment. The rich materials and subtle use of angles in these lamps seamlessly blend elegance and playfulness.





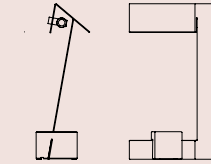

Clark Table

L 10 x W 4.75 x H 18 in
L 254 x W 121 x H 457 mm

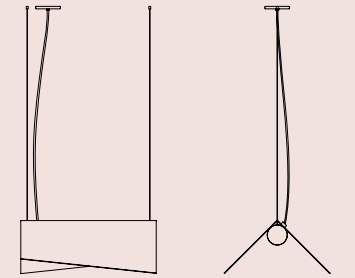

Clark Suspension

L 24, 46 or 69 x W 16 x H 8 in
L 584, 1168 or 1752 x W 406 x H 203 mm
Total height variable

All Clark Models

Finishes : Black / Black / White
Materials : Brass, Aluminum, Marble
G9 LED bulb (Table), LED array (Suspension)
120-277V / 220-240V





Beaubien Collection

The Beaubien Collection's strong black lines bend in and out of space, moving effortlessly between simplicity and ornamentation. Round and cubic brass connectors complete the lamps' structures and add a rich material contrast to the powder coated rods. The collection's industrial and graphic aesthetic is imbued with a palette of influences, from traditional Chinese screens to the Memphis movement. Each influence strengthens the collection, creating nuance within its timeless character.











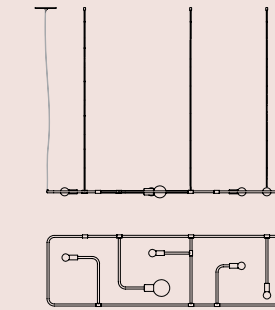

Baubien (ceiling)
 L 60 x W 17 in
 L 1524 x W 432 mm
 Height variable

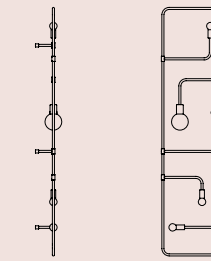

Baubien (wall)
 L 17 x W 4.5 x H 60 in
 L 432 x W 102 x H 1524 mm

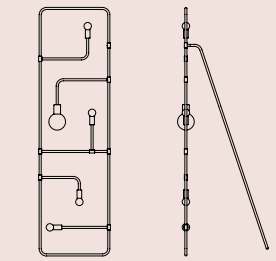

Baubien (floor)
 L 17 x W 20 x H 60 in
 L 432 x W 508 x H 1524 mm

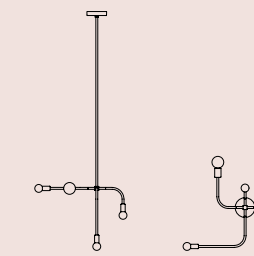

Baubien Suspension
 L 23 x W 24 x H 17.5 in
 L 580 x W 640 x H 448 mm
 Total height variable

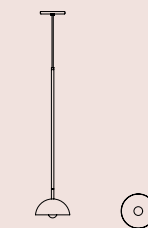

Baubien Simple Shade
 Ø 7 in
 Ø 178 mm
 Height variable
 Min. Height: 30 in
 762 mm

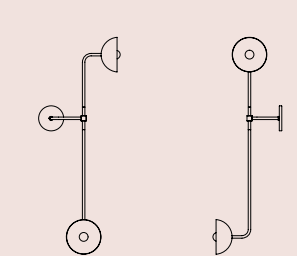

Baubien Wall Double Shade
 L 16 x W 14 x H 42 in
 L 406 x W 356 x H 1118 mm

All Beaubien Models
 Finishes: All Brass (Baubien ceiling / wall / floor)
 Black + Brass / Black + Graphite
 Materials: Brass, Steel, Aluminum
 G9 LED bulb
 120V / 240V





Cliff Collection

The Cliff Collection brings together the best of Lambert & Fils in its use of many signature elements. Natural brass and matte black rods provide structure for lamps with elegant shades and a range of spherical bulbs. The finishing and connection details complete this full collection of lamps, giving character and nuance to their robust, functional forms.













Cliff Suspension

L 42 x W 22 x H 18 in
 L 1092 x W 559 x H 457 mm
 Total height variable

Cliff Floor

L 24 x W 40 x H 63 in
 L 610 x W 1060 x H 1600 mm

Cliff Table

L 11 x W 6 x H 28 in
 L 279 x W 152 x H 711 mm

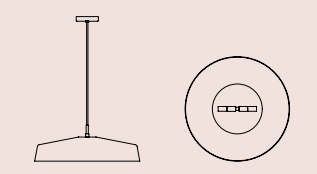

Cliff Dome

ø 24 in x H 8.5 in
 ø 610 mm x H 216 mm
 Total height variable

Softwire

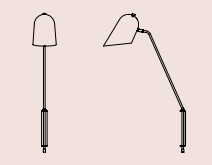

Hardwire

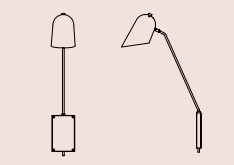

Cliff Wall

L 18.25 x W 5.25 x H 33 in
 L 463 x W 127 x H 838 mm

All Cliff Models

Finishes:
 Brass / Graphite (Suspension)
 Black + Brass / Black + Graphite (Dome)
 Black + Brass / Black + Graphite / White + Brass (Floor, Wall, and Table)
 Materials: Brass, Steel, Aluminum, Marble
 G9 LED bulbs (Suspension and Dome)
 E26/E27 sockets (Wall, Table, and Floor)
 120V / 240V





Dot Collection

The Dot Collection combines the directness of exposed, spherical bulbs with the rich materiality of brass. Focused, geometric compositions contain these two features, balancing line, surface, and luminous points. The result is a collection of lamps based in the reflectivity of brass—lamps that are both atmospheric and firm.







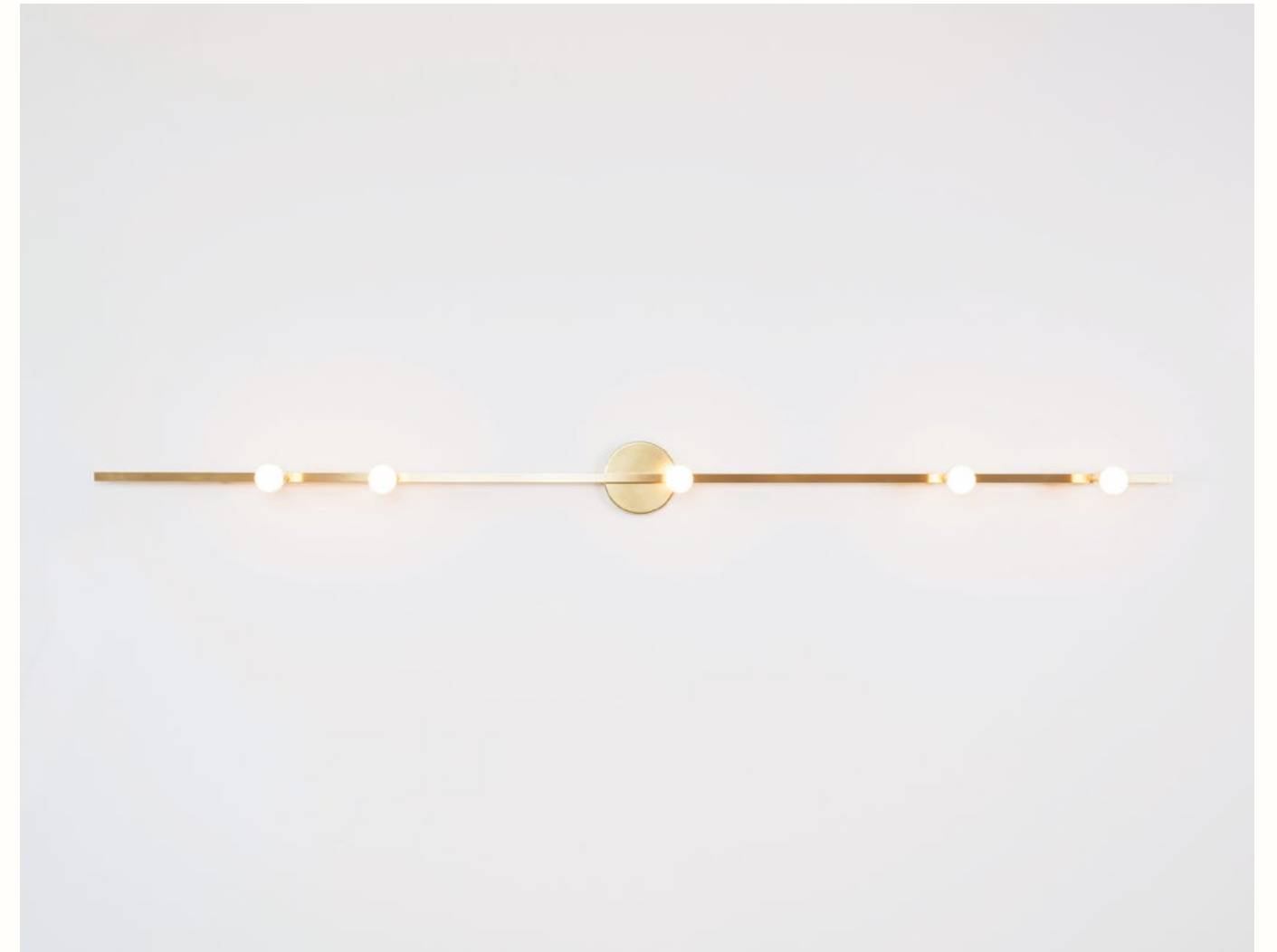



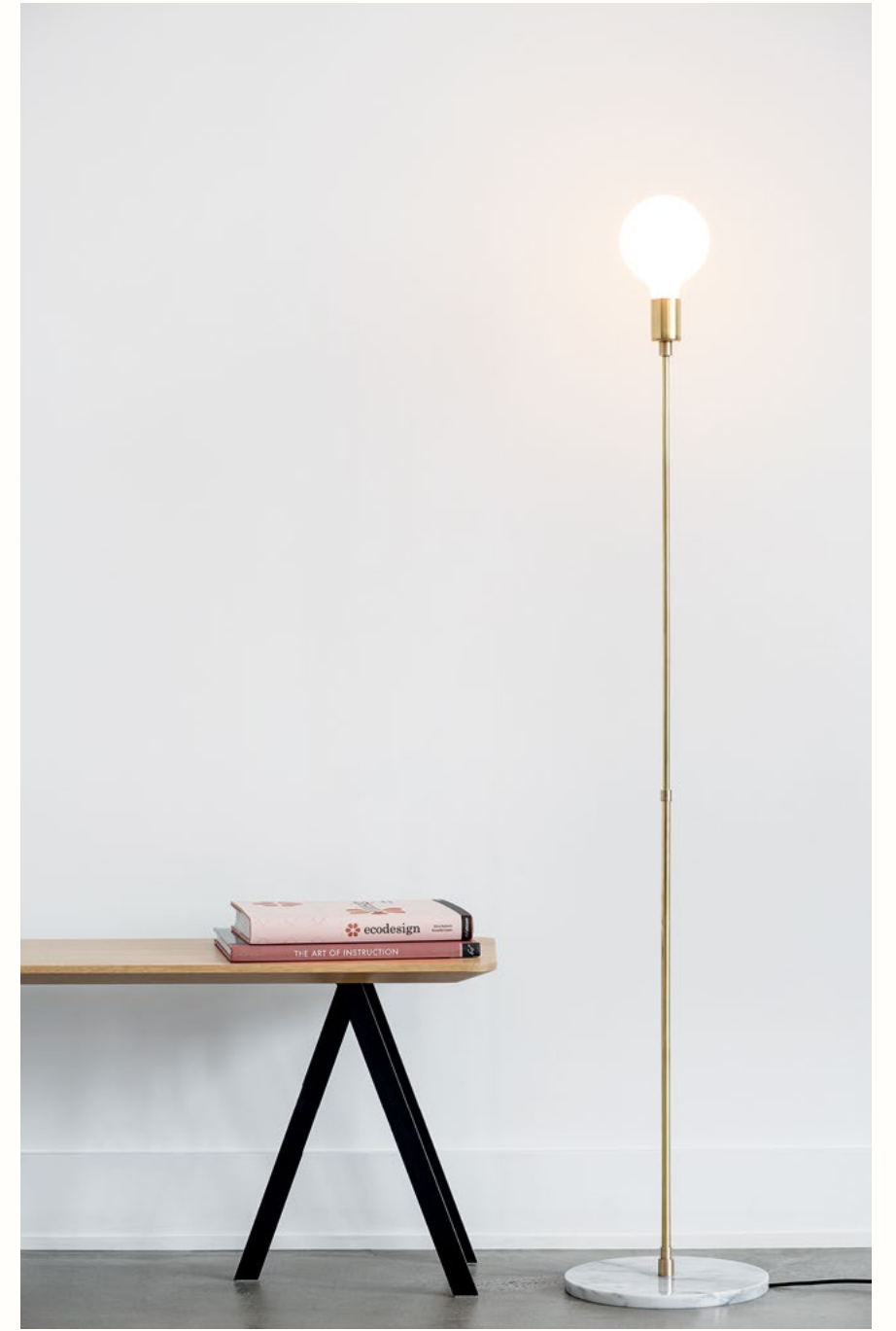





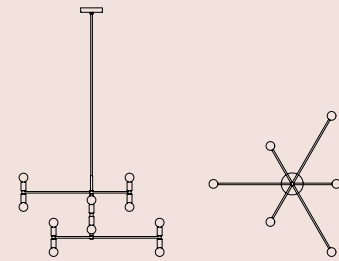

Atomium
 ø 38 x H 19 in
 ø 965 x H 483 mm
 Total height variable

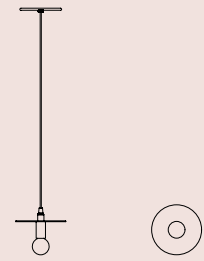

Dot Suspension
 ø 6 x H 5 in
 ø 152 x H 127 mm
 Total height variable

Hardwire



Softwire

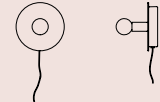

Dot Wall
 Ø 6 x W 4.25 in
 Ø 152 x W 102 mm



Dot Table
 ø 6 x H 5 in
 ø 152 x H 127 mm
 Total height variable



Luna Floor
 Ø 11 x H 58 in
 Ø 279 x H 1448 mm



Luna Table
 Ø 6 x H 27 in
 Ø 152 x H 686 mm

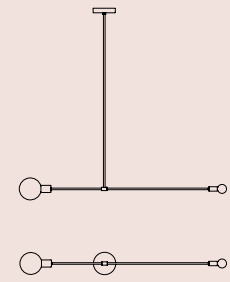

Antipode
 L 47 x W 4 x H 4 in
 L 1194 x W 100 x H 100 mm
 Total height variable

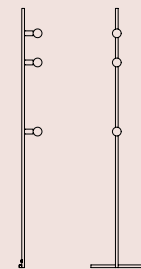

Dot Line Floor
 L 12 x H 60 in
 L 305 x W 1524 mm

Hardwire

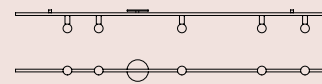

Softwire

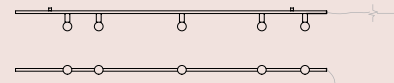

Dot Line Wall
 L 72 x W 5 x H 0.63 in
 L 1829 x W 127 x H 16 mm

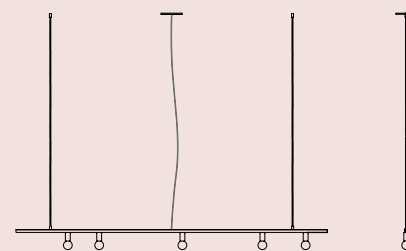

Dot Line Suspension
 Body: L 72 x H 5 in
 L 1829 x H 127 mm
 Height variable

All Dot Models

Finishes : Brass (all)
 Graphite (Atomium, Luna, and Atipode)
 Black / White (Wall, Suspension, Table, and all Dot Line models)
 Materials : Brass, Steel, Aluminum, Marble
 G9 LED bulbs
 120V / 240V





Waldorf Collection

The main feature of the Waldorf Collection combines an open hemispherical shade with a cylindrical socket cover. This composite shade is deployed in suspension and wall-mounted configurations with natural brass and powder coated rods. Swivelling shades and other moving parts add functional flexibility to the crisp, streamlined forms of the collection.

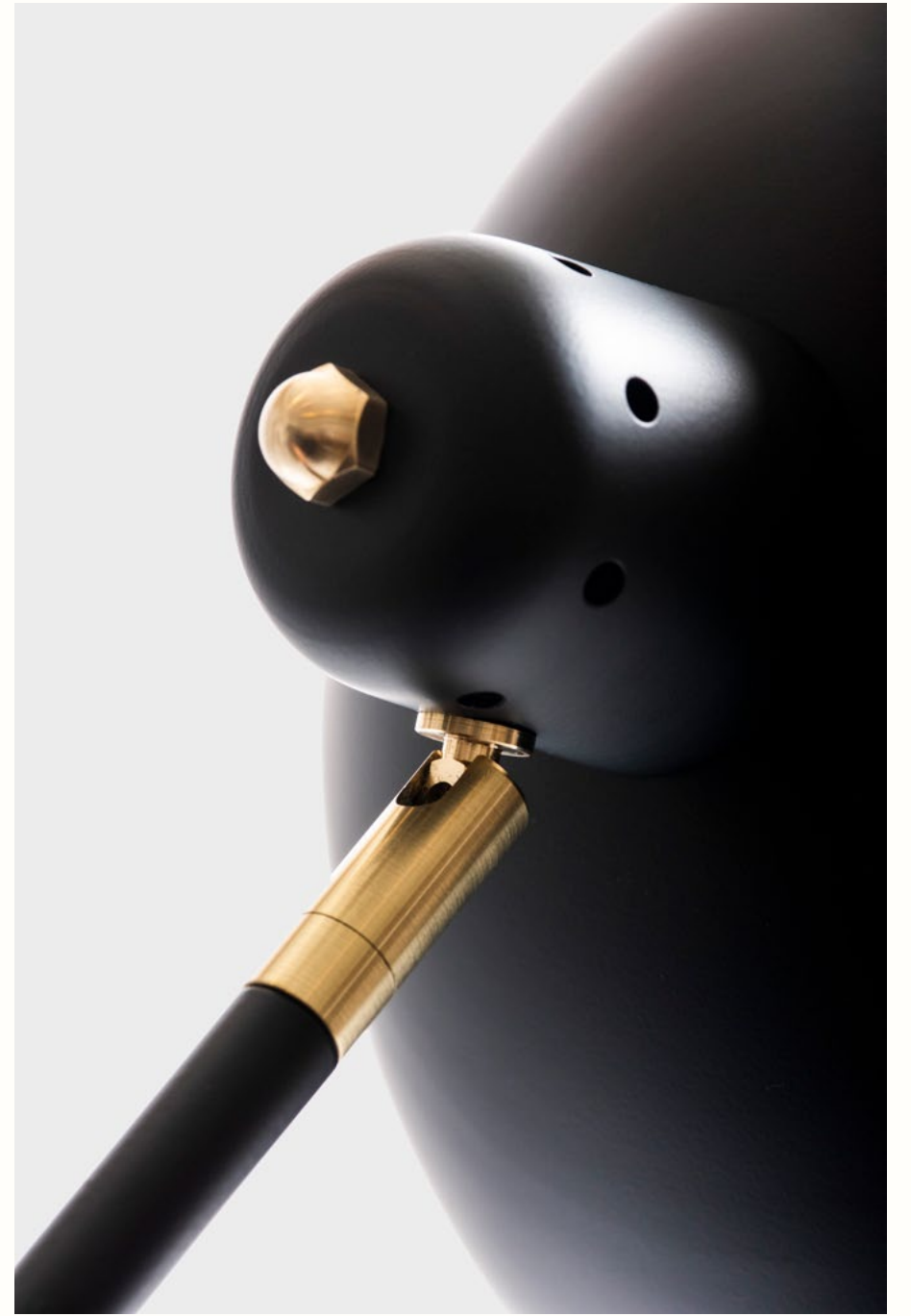

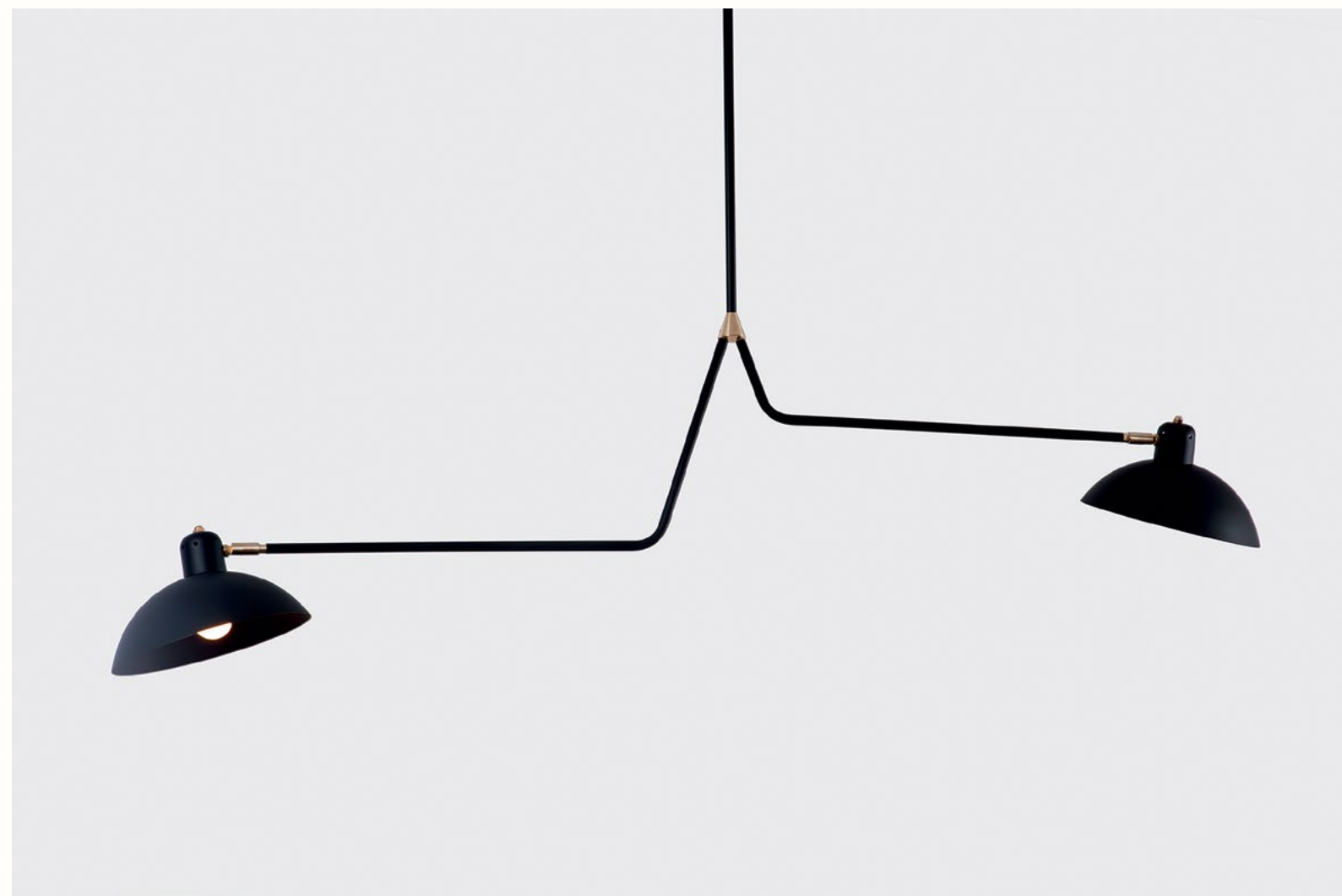

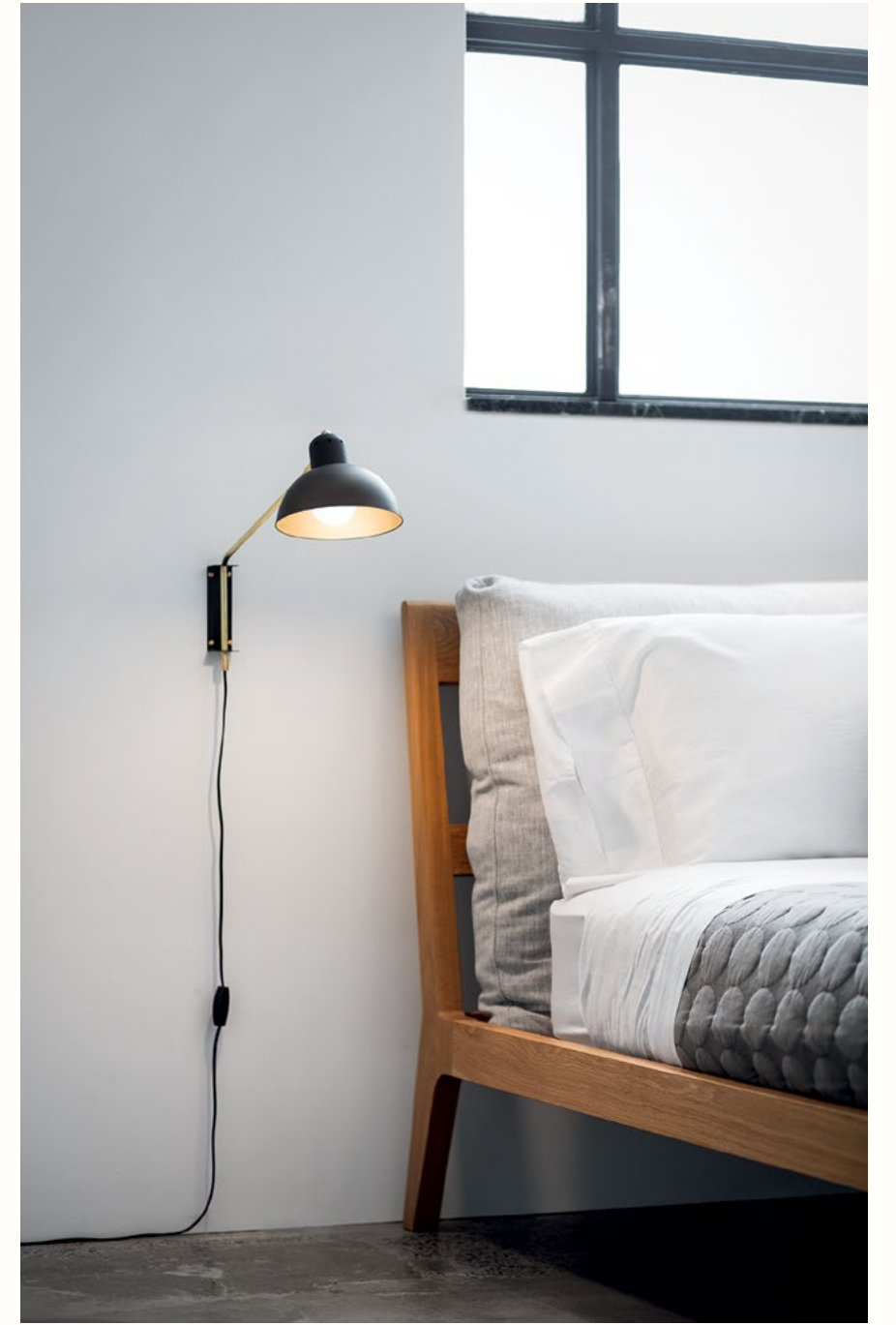

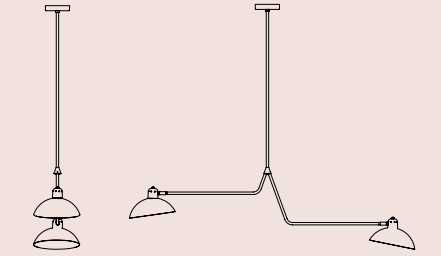
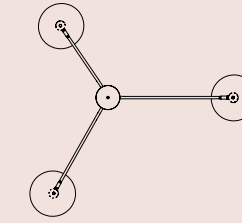
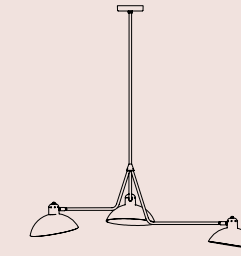

Waldorf Suspension Triple

ø 60 x H 18 in
 ø 1520 x 460 mm
 Total height variable

Waldorf Suspension Triple

L 60 x W 9.5 x H 18 in
 L 1520 x W 240 x 229 mm
 Total height variable

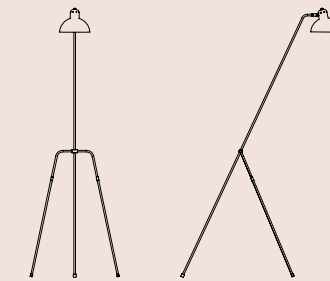

Hardwire

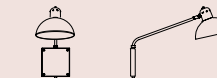

Softwire

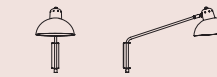

Grue Floor

L 25 x W 19 x H 60 in
 L 635 x W 483 x H 1524 mm

Waldorf Wall Small

L 18 x W 7 x H 12.5 in
 L 457 x W 178 x H 318 mm

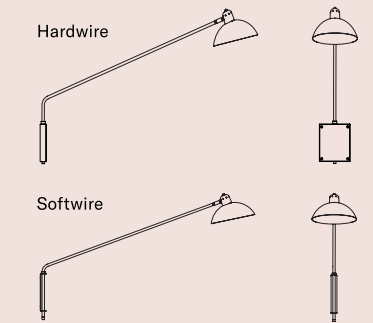

Waldorf Wall Large

L 24 to 54 x W 9.5 in
 L 610 to 1372 x W 241 mm

All Waldorf Models

Finishes: Black + Brass / Black + Graphite / White + Brass
 Materials: Brass, Steel, Aluminum
 G9 LED bulbs
 120V / 240V





Lambert & Fils is a design studio specializing in handmade lighting, founded by Samuel Lambert and based in Montreal, Canada.

One of the country's most energized hubs for collaborative design, Lambert & Fils hosts a multidisciplinary team of over 50 designers, fabricators, photographers and other creatives. Preserving the bond between design and making, all lighting is conceived, designed and hand-assembled at our atelier in downtown Montreal.

The studio has created installations around the world, hosting a six-day pop-up café for Milan's Fuorisalone, taking over the display windows at the Conran Shop during Paris Design Week, and devising a grand floral installation at Stockholm Design Week. Lambert & Fils also launched

Corridor, a public exhibitions space in Montreal adjacent to our workshop which explores the intersection of art and design.

Through original contemporary collections and collaborations with international designers, Lambert & Fils investigates the many shapes of light—meditating on voids, volumes and the collective memory of materials. We have created lighting for the likes of Hôtel Bachaumont in Paris, Paramount House in Sydney and the Kinfolk gallery and head offices in Copenhagen, among many others.

Like the studio itself, these explorations trace where the unexpected meets the universally poetic—and where humility meets complex design.

Lambert & Fils Studio

Office and Workshop

6250 Hutchison, suite 100
Montréal, QC
Canada H2V 4C5

514-394-0762

Website

www.lambertetfils.com

General Inquiries

info@lambertetfils.com

Orders and Quotes

order@lambertetfils.com

Distribution Inquiries

pierre-antoine@lambertetfils.com

Media Requests

media@lambertetfils.com

Graphic Design

Shane Krepakevich

Photography

Arseni Khamzin: www.arsenikhamzin.com

Adrien Williams: www.adrienwilliams.com

Jonas Bjerre-Poulsen (Kinfolk, p.108 & p.118)

lambert&fils

