

THE ACCENT

NEMO | **NEMO**_{STUDIO}

NEMO

FOX	10
SWAN	18
KEPLER PETITE	26
TUBES CEILING	36
DESK MATRIX	46
FIX 100°	62
ARA DIM TO WARM	70

NEMO_{STUDIO}

PLINT	84
LUX GARDEN	94
LUX S	98
LUX W	102
ZIRKOL LINEAR UGR	116

NEMO



FOX | BERNHARD OSANN

“As in nature, a minimal of energy and material can fulfil a function at its best”.



ENG

FOX is a dimmable LED floor lamp. Steel matte black painted structure and base. Aluminum spot with optional antiglare filter. Its slewing arc and its directable cylindrical head allow to flexibly orientate the light beam for a consistent warm diffused light.

DEU

LED-Stehleuchte für direkte Beleuchtung. Matt-schwarze Stahlstruktur. Spot-Kopf aus Aluminium mit optionaler Wabenblende als Blendschutz. Der schwenkbare Bogen und der verstellbare zylindrischer Spot ermöglichen die flexible Positionierung des warmen Lichtstrahles.

ITA

FOX è una piantana LED dimmerabile per l'illuminazione diretta. Struttura e base in acciaio verniciato nero opaco. Spot in alluminio con filtro antiabbagliamento opzionale. Il suo arco di rotazione e la sua testa cilindrica orientabile, consentono di dirigere in modo flessibile il fascio luminoso per una luce uniforme e calda.

FR

FOX est un lampadaire LED dimmable. Structure et base en acier peint noir mat. Spot en aluminium avec filtre optionnel nid d'abeille pour anti-éblouissement. Son arc de pivotement et sa tête cylindrique orientable permettent d'orienter avec flexibilité le faisceau lumineux pour une lumière diffuse chaude et uniforme.



90° orientable aluminum spot

FOX

<i>voltage/current</i>	<i>max power</i>	<i>source</i>	<i>flux</i>	<i>optic</i>	<i>CRI</i>	<i>switching</i>	<i>CCT</i>	<i>finish</i>	<i>code</i>
110/240V	15W	LED board	839lm	60°	90	dimmable	2700K	matte black painted	FOX LN2 21
<i>note</i>	cable length 3,5m, dimmer on cable, antiglare accessory included, 90° orientable spot								

☐ **IP20**



antiglare filter (included)



steel matte black painted base

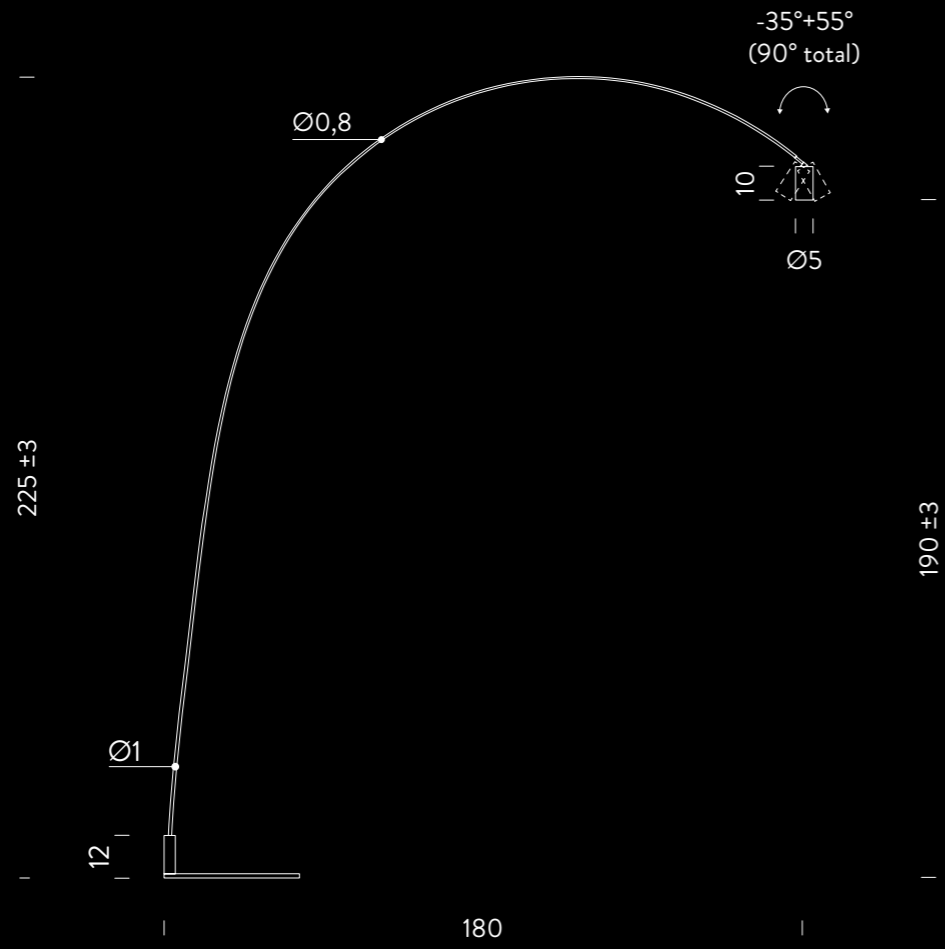

15W / 839lm

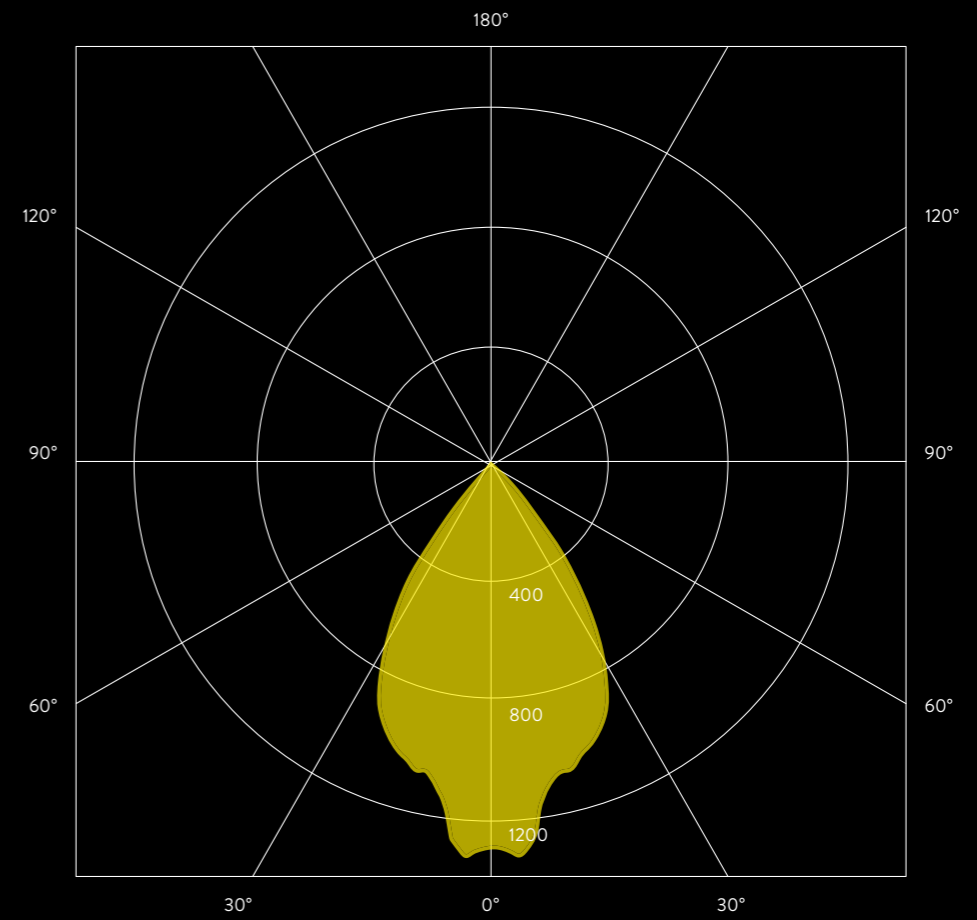

$-20^\circ + 20^\circ$
(40° total)

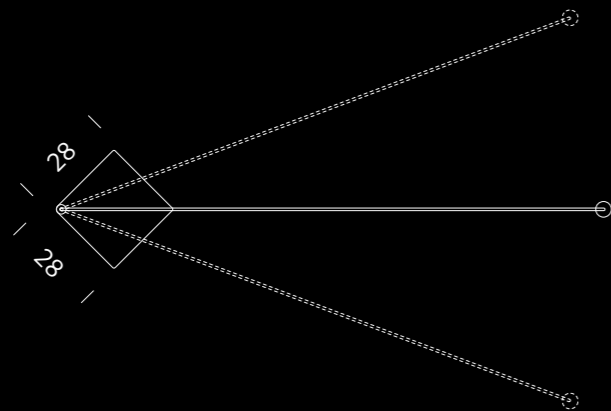

CO / C180 cd / 1000lm

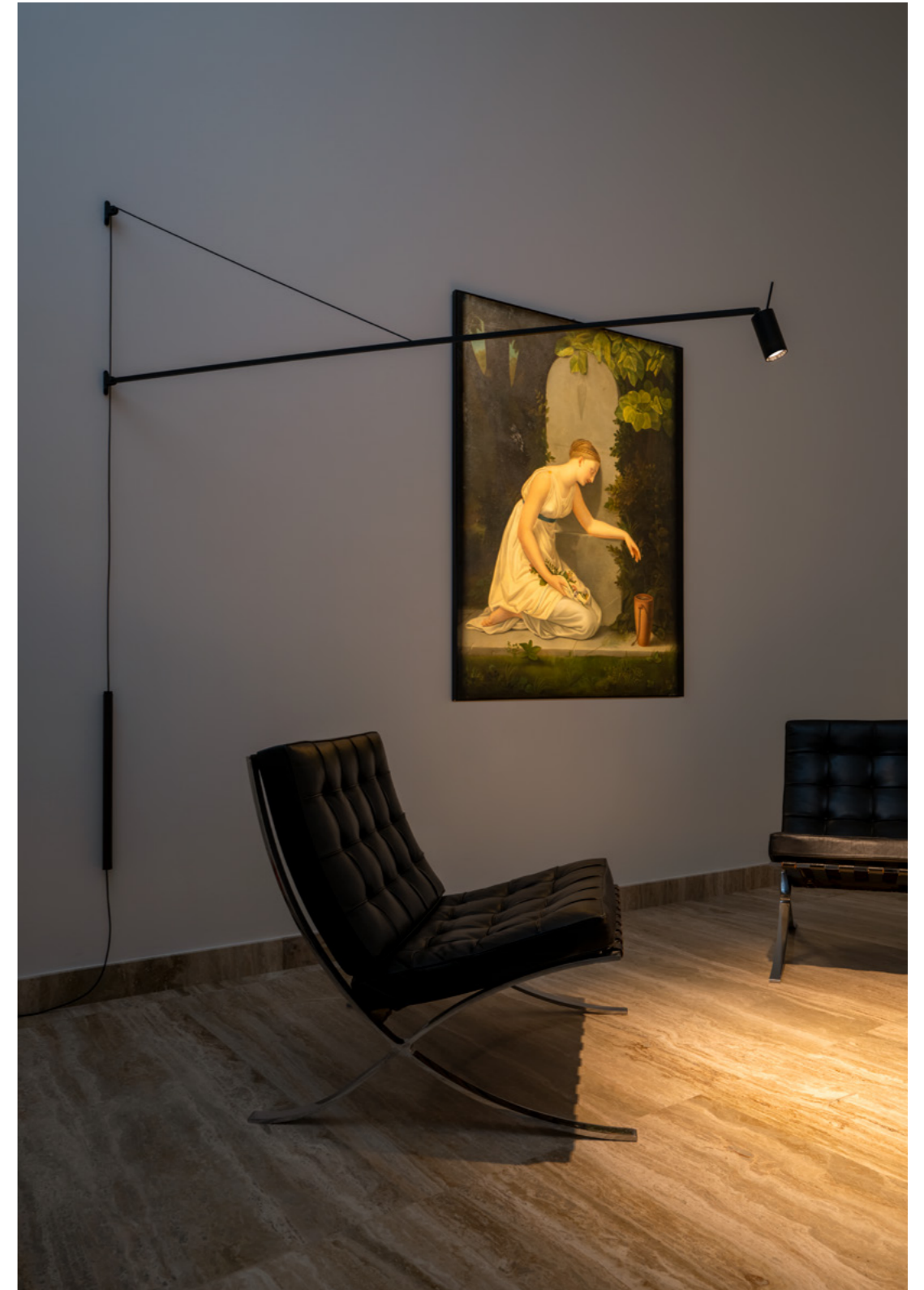

SWAN | BERNHARD OSANN

“I am fascinated by kinetic objects and thus searched for a new way to get a wall lamp moving.”



ENG

SWAN is a dimmable LED wall lamp for direct lighting. Aluminium matte black painted structure. Arm rotation of 40° vertically, contained by a leathered counterbalance, and 180° horizontally. Its directable cylindric head allows to flexibly orientate the light beam, with optional antiglare filter. Dimmer on cable.

DEU

SWAN ist eine dimmbare LED-Wandleuchte. Der Arm aus matt-schwarzem Aluminium ist um 180° vertikal-schwenkbar. Die Höhe des Armes wird mit Hilfe des Gegengewichts aus Leder um bis zu 40° eingestellt. Der Spot kann nach Wunsch orientiert werden. Optionale Waben-Blende als Blendschutz im Lieferumfang enthalten. Dimmer am Kabel.

ITA

SWAN è una lampada da parete a LED dimmerabile. Struttura in alluminio nero opaco. Il braccio può essere ruotato orizzontalmente di 180° e verticalmente di 40°, grazie a un contrappeso rivestito in cuoio. Lo spot cilindrico con filtro antiabbagliamento opzionale, consente di orientare il fascio luminoso in modo flessibile. Dimmer sul cavo.

FR

SWAN est une applique LED dimmable pour un éclairage direct. Structure en aluminium peint en noir mat. Rotation verticale du bras de 40°, contenue par un contrepoids en cuir, et horizontalement de 180°. Sa tête cylindrique orientable avec filtre optionnel nid d'abeille pour anti-éblouissement permet d'orienter avec flexibilité le faisceau lumineux. Dimmer sur câble.

SWAN

<i>voltage/current</i>	<i>max power</i>	<i>source</i>	<i>flux</i>	<i>optic</i>	<i>CRI</i>	<i>switching</i>	<i>CCT</i>	<i>finish</i>	<i>code</i>
110/240V	15W	LED board	839lm	60°	90	dimmable	2700K	matte black painted	SWA LN2 31
<i>note</i>	cable length 3,5m, antiglare accessory included, 135° orientable spot								

☐ **IP20**



135° orientable aliminum spot

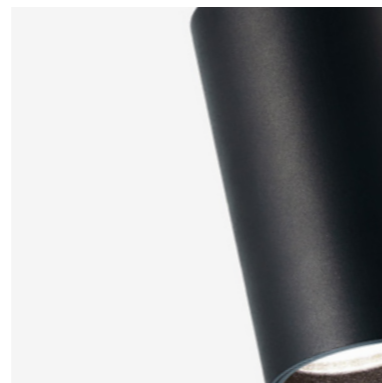

optional antiglare filter (included)



bracket for wall attachment



brown leathered counterbalance

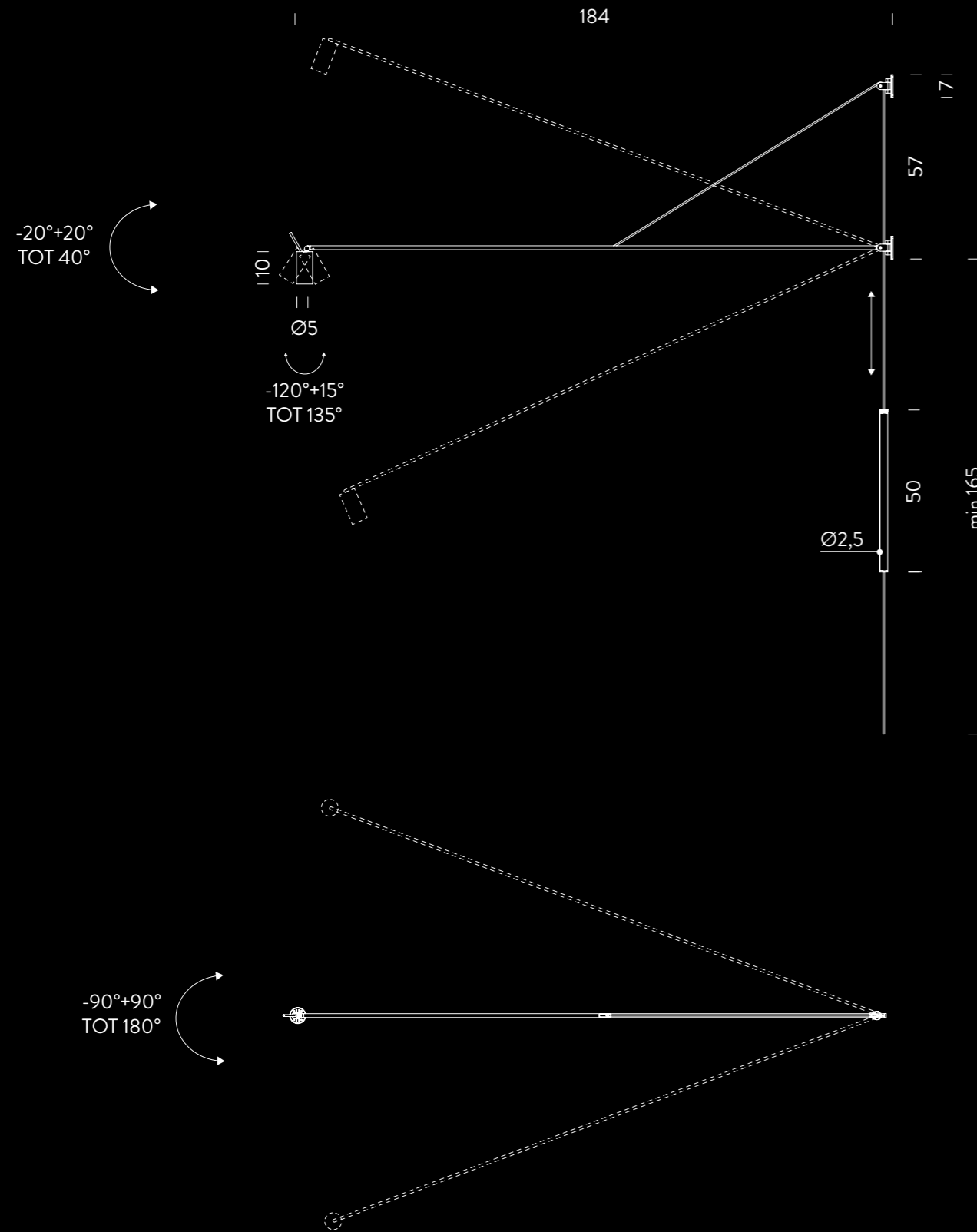

15W / 839lm

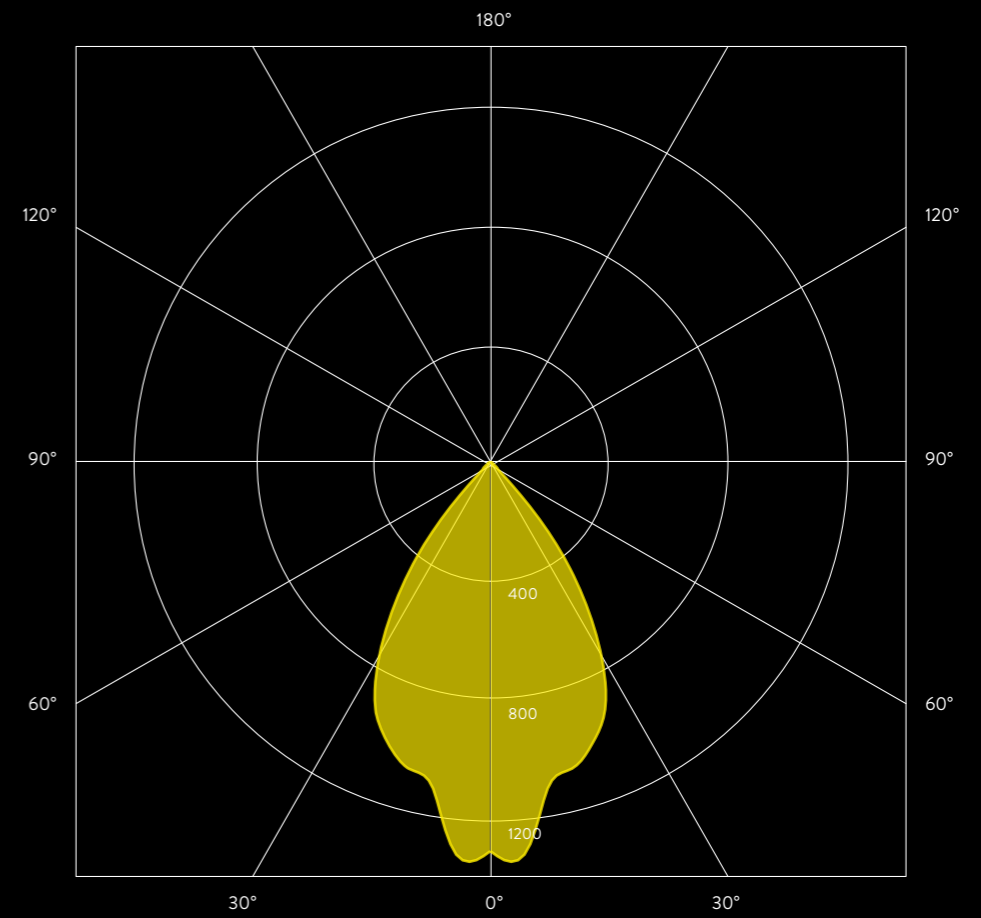

CO / C180 cd / 1000lm

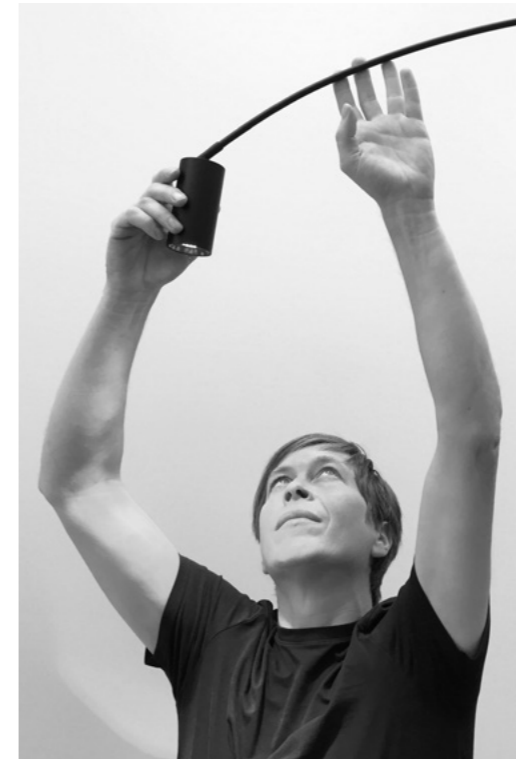

Bernhard Osann, born in Augsburg, runs his design studio in Hamburg since 2014. He studied at the University of Fine Arts in Hamburg.

He experiments with physical laws and geometrical shapes to find new unconventional solutions to simplify objects. The results are minimalistic dynamic constructions that move, interact with space and invite you to connect. During the design process, functionality and producibility are always on focus.

SWAN and FOX are examples of the many successful collaborations between Bernhard Osann and Nemo, in both cases effectively combining conceptualization and technicality.



KEPLER PETITE | ARIHIRO MIYAKE

“I am drawn to experimenting with techniques never tried before, which of course leads to challenging projects.”

ENG

The smallest version of the KEPLER collection, with downlight emission for direct lighting. Suspension lamp in extruded aluminum powder coated. Available in matte white, black and gold. The continuous linear structure is inspired by the geometric principle of the Moebius strip and realised using a three-dimensional process of shaping the extruded aluminium structure.

DEU

Die kleine Version der KEPLER mit Downlight für direkte Beleuchtung. Die Struktur besteht aus einer Aluminium-Extrusion, das durch ein von Nemo entwickeltes dreidimensionales Bearbeitungsverfahren nach dem geometrischen Prinzip des Möbius-Streifens hergestellt wird. Verfügbar in matter Schwarz-, Weiß- oder Goldlackierung.

ITA

Versione dalle dimensioni più ridotte della collezione KEPLER, disponibile solo in downlight. Lampada a sospensione in estruso d'alluminio verniciata a polveri. Disponibile nelle finiture opache bianco, nero e oro. La linea continua è realizzata attraverso un processo di lavorazione tridimensionale dell'estruso di alluminio ingegnerizzato da Nemo ed è disegnata sulla base del principio geometrico del nastro di Moebius.

FR

Version aux dimensions encore plus réduites de la collection KEPLER, disponible uniquement en downlight. Suspension en aluminium extrudé peint. Disponible en blanc mat, noir et doré. La ligne continue, dessinée sur la base du principe géométrique du ruban de Moebius, est réalisée grâce à un procédé d'usinage tridimensionnel de l'extrudé d'aluminium.



matte gold finish

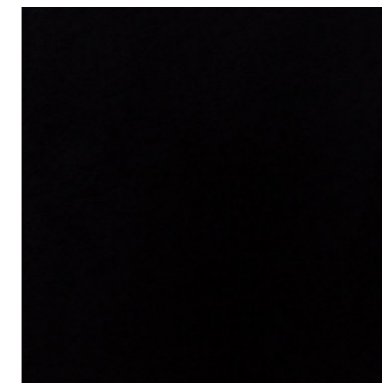

matte black finish



matte white finish

KEPLER PETITE

<i>voltage/current</i>	<i>max power</i>	<i>source</i>	<i>flux</i>	<i>emission</i>	<i>CRI</i>	<i>switching</i>	<i>CCT</i>	<i>finish</i>	<i>code</i>
110/240V	50W	linear LED	1954lm	downlight	85	dimnable 1-10V	2700K	white	KES LWW 54
								black	KES LNN 54
								gold painted	KES LOW 54
							3000K	white	KES LWW 52
								black	KES LNN 52
								gold painted	KES LOW 52

note

adjustable cable length from 2,5m to 0,4m, DALI version on request

 **IP20**



matte white finish

KEPLER COLLECTION

50W / 1954lm

KEPLER PETITE

KEPLER MINOR

KEPLER

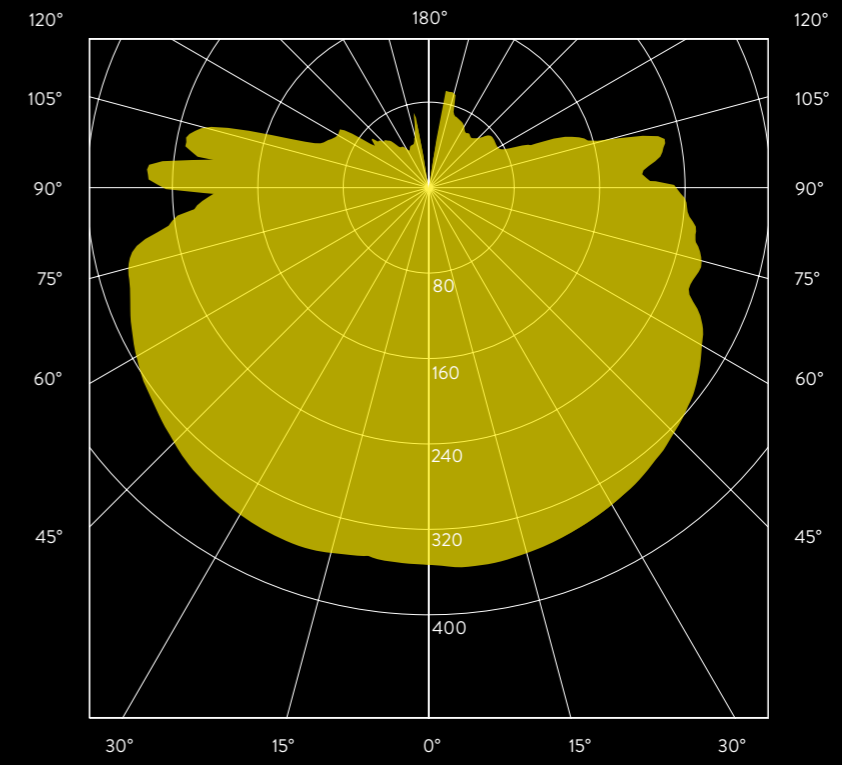
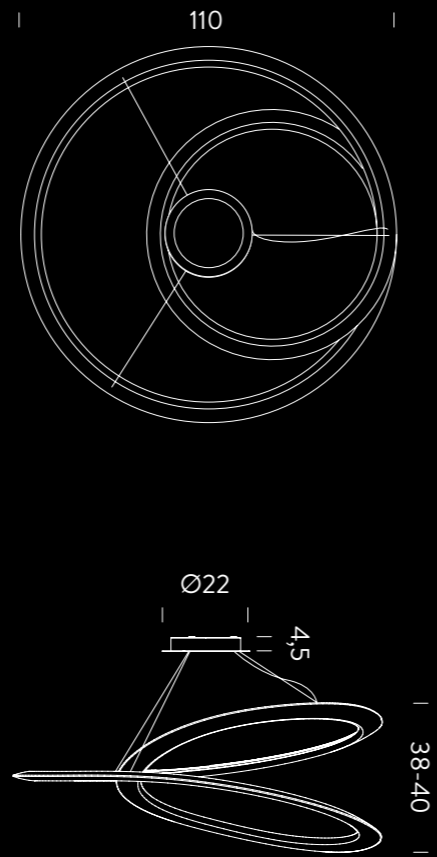
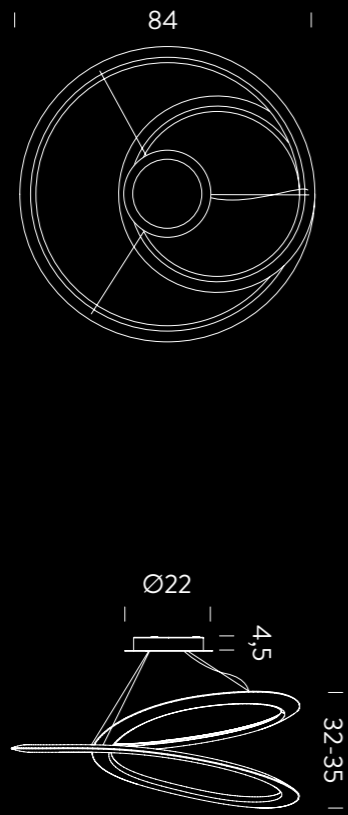
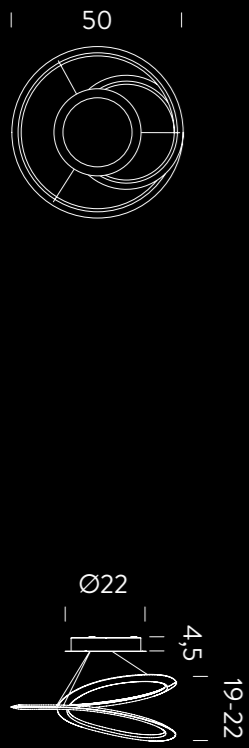

CO / C180 cd / 1000lm

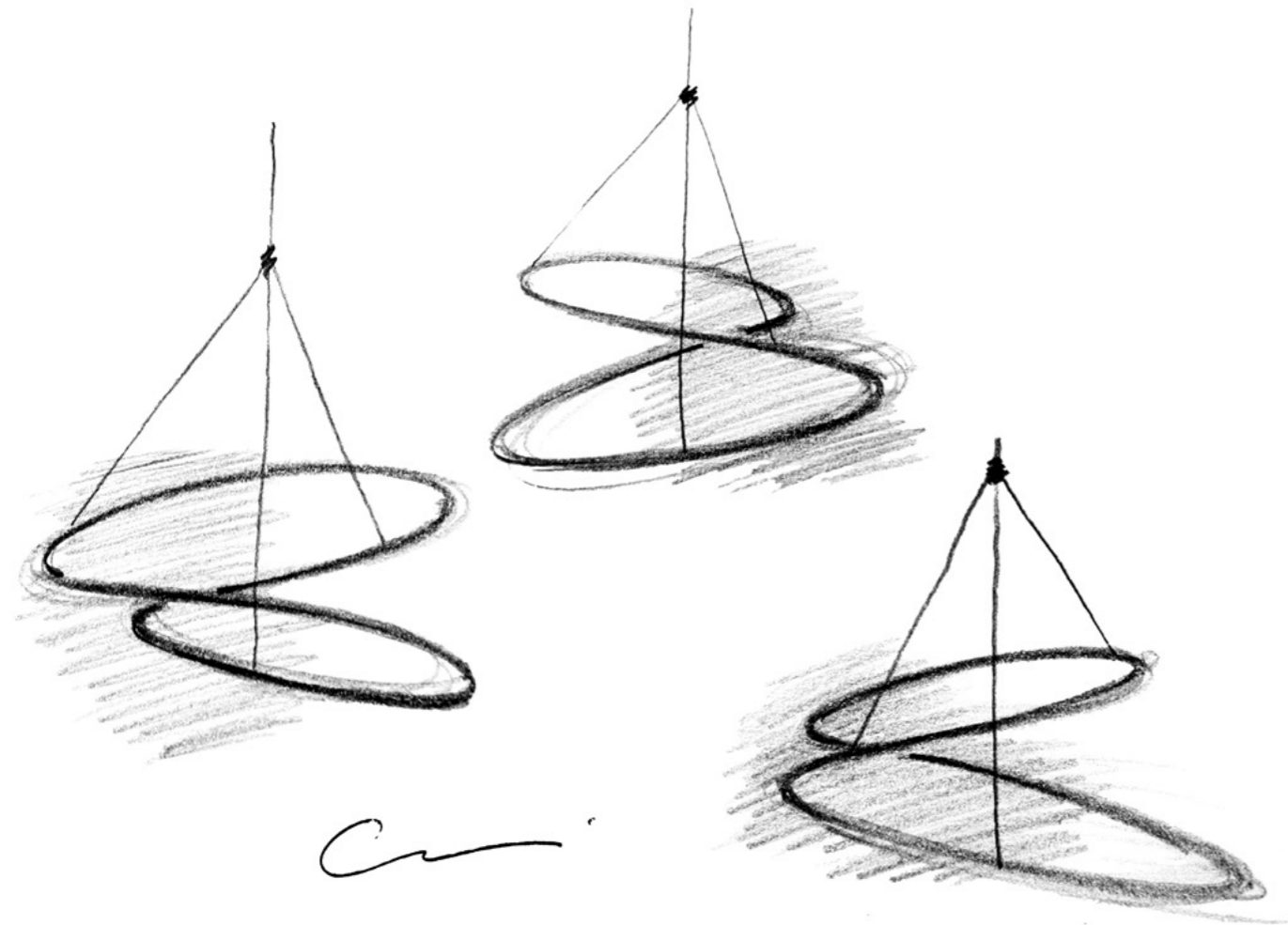

Arihiro Miyake was born in Japan in 1975. He started his design studies in his motherland at Kobe Design University, then moved to Finland to finish a Master's degree in furniture and space design at Aalto University.

Arihiro Miyake Studio opened in 2014, allowing him to investigate multiple areas including interior, product and lighting design. His collaboration with Nemo started with projects such as In the Wind and Kepler, creating new paradigms in the lighting world.



TUBES CEILING | CHARLES KALPAKIAN

“Suspended without gravity, enlightened with technology”.

ENG

The latest addition to the TUBES collection, composed of tubular elements in extruded aluminum. A more compact and powerful ceiling version, with two vertical tubes, one fixed to the ceiling and the other one rotatable like an arm and adjustable to user needs. Both cylinders have a 340 ° rotation. Available in white and black.

Opal polycarbonate diffusers.

DEU

Die neue Ergänzung der TUBES-Kollektion, bestehend aus röhrenförmigen Elementen aus stranggepresstem Aluminium. Diese Deckenversion ist kompakter und kräftiger mit seinen 2 vertikalen Röhren, eine an der Decke befestigt und die andere dreht sich wie ein Arm, einstellbar auf die Bedürfnisse des Nutzers. Beide Zylinder können um 340° rotiert werden. In den Ausführungen Weiß und Schwarz erhältlich. Opal Polycarbonat Diffusoren.

ITA

La collezione TUBES si arricchisce di una nuova versione a soffitto più compatta e potente, regolabile in base a differenti esigenze. Due elementi tubolari a plafone ruotano di 340°: il primo fissato al soffitto in verticale ruota su se stesso, mentre l'altro disegna una parabola. Disponibile in bianco o nero. Diffusori in policarbonato opalino.

FR

Le dernier arrivée de la collection TUBES, composé d'éléments tubulaires en aluminium extrudé. Cette version à plafond est plus compacte et plus puissante avec 2 tubes verticaux, l'un fixé au plafond et l'autre tournant comme un bras, réglable selon les besoins de l'utilisateur. Les deux cylindres ont une rotation de 340 °. Disponible en blanche et noir. Diffuseurs en polycarbonate opale.

TUBES CEILING

<i>voltage/current</i>	<i>max power</i>	<i>source</i>	<i>flux</i>	<i>emission</i>	<i>CRI</i>	<i>switching</i>	<i>CCT</i>	<i>finish</i>	<i>code</i>
230V	2x4,2W	LED board	374lm	orientable	85	dimnable TRIAC	2700K	grey white/grey white	TTB LWW 41
								black/black	TTB LNW 41

note

orientable on two axes, also available in 120V, matte grey white RAL 9002

 **EAC IP20**

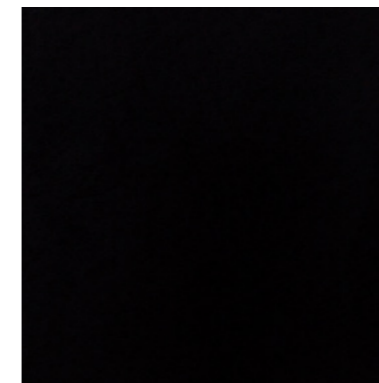

matte black finish



matte grey white finish



matte black finish

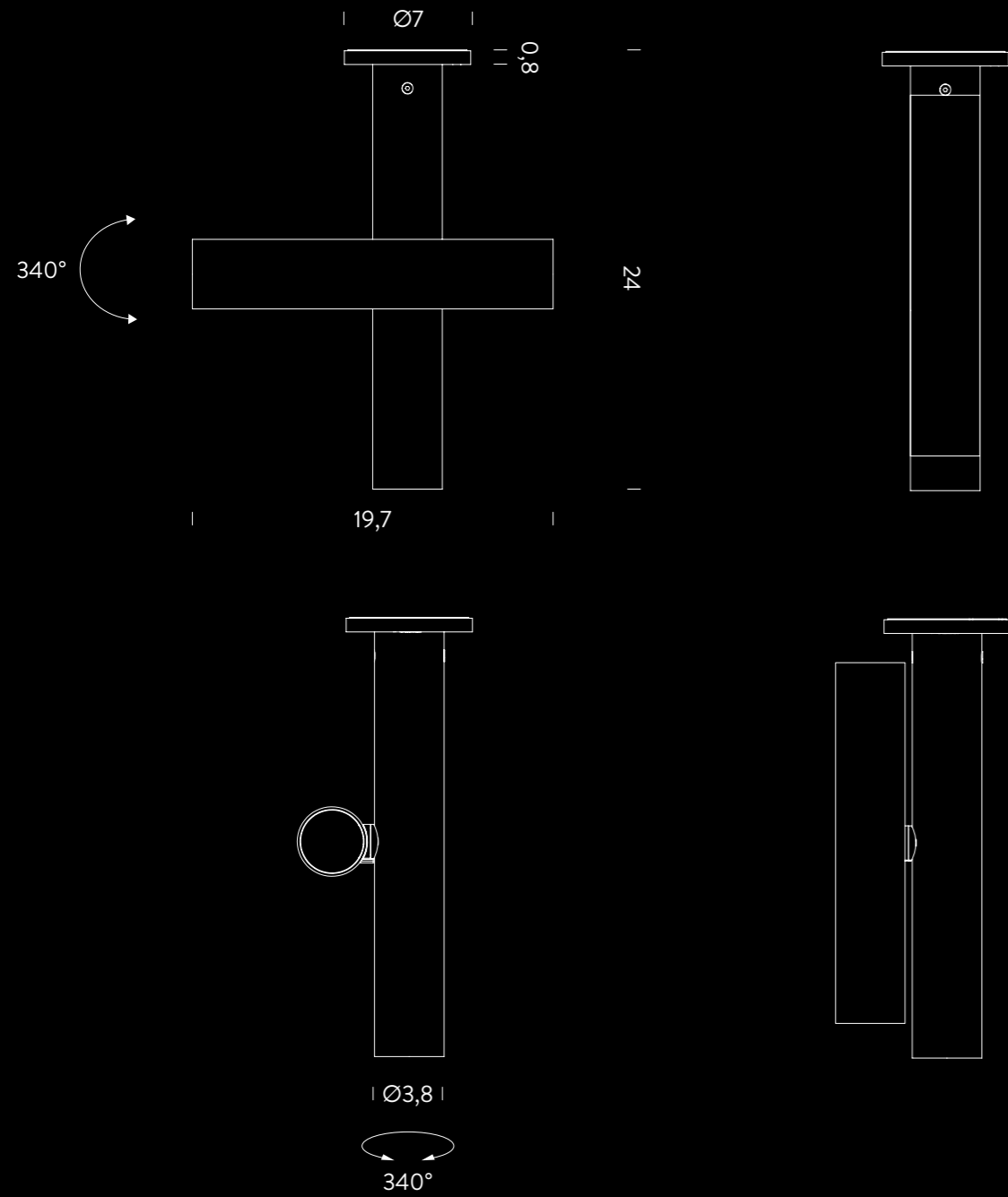

2 x 4,2W / 374lm

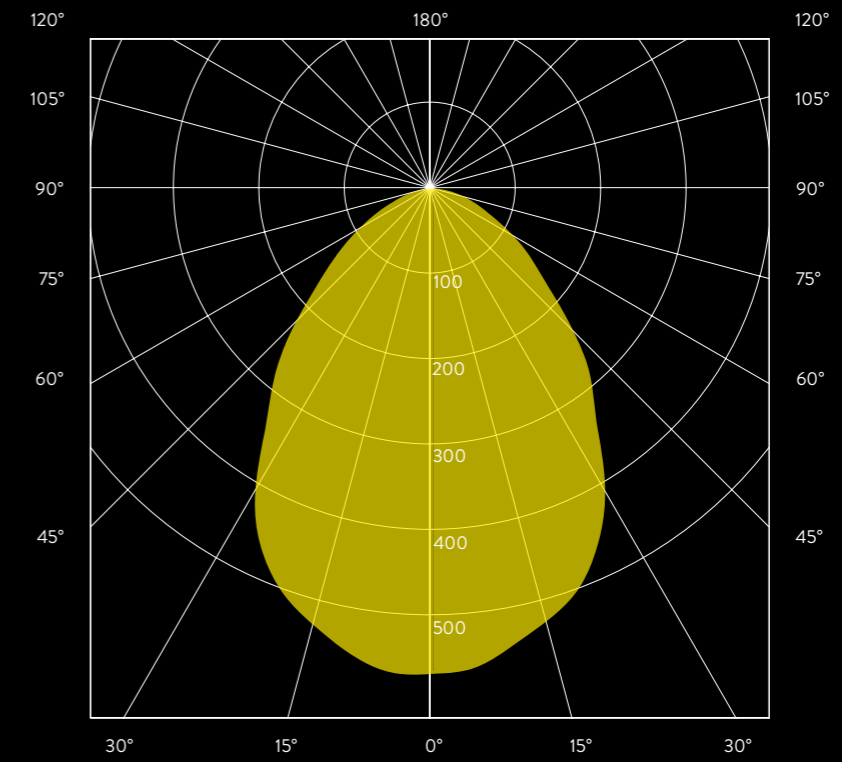

CO / C180 cd / 1000lm

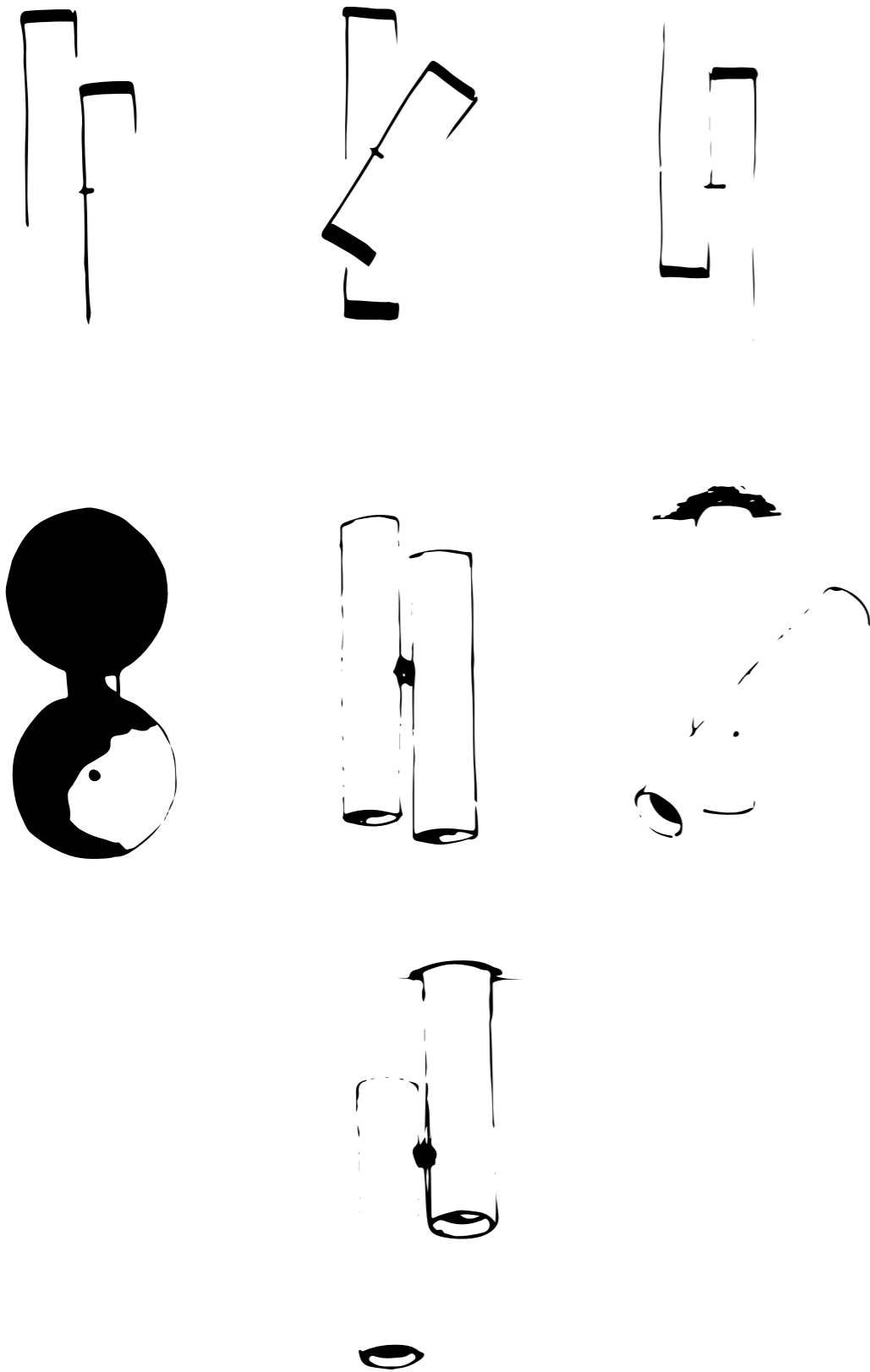

Charles Kalpakian was born in Beirut in 1982. In 2011, after collaborating with Christophe Pillet, he opened his own studio.

Geometric lines are the signature of his innovative approach, fusing his oriental roots, his knowledge of design and the decorative arts as well as his passion for the urban contemporary culture.

Tubes and Wall Shadows reflect this timeless aesthetic which brings the classics back into our homes with a fundamental futuristic twist.



DESK MATRIX

“Sleek continuous light lines with an infinite number of constellations”.

ENG

With DESK MATRIX, our Linescapes System is proposed in pre-configured rectangular and square shapes, vertical and horizontal. Sleek continuous light lines with an infinite number of constellations to fit any table size or interior design need. Available in 2700K or 3000K, black or white finish. Compositions come fully equipped to work right out of the box, 1-10V dimmable driver and its case included.

DEU

Mit der DESK MATRIX-Reihe aus unser Linescapes-System sind jetzt bereits fertige Konfigurationen lieferbar, rechteckig und quadratisch, vertikal und horizontal. Durchgehende Lichtlinien in vielen verschiedenen Konstellationen für jede Tischgröße und jedes Interior Konzept. Erhältlich in 2700K oder 3000K, schwarz oder weiß. Die Kompositionen werden bereits vollständig geliefert, sind damit sofort einsatzbereit. Dimmbare 1-10V Driver und Baldachin sind im Lieferumfang enthalten.

ITA

Con DESK MATRIX, Linescapes System è proposto in forme rettangolari o quadrate, da installare verticalmente e orizzontalmente. Eleganti linee luminose continue consentono di completare un numero teoricamente infinito di dimensioni per adattarsi a qualsiasi misura di tavolo o ambienti. 2700K o 3000K, finiture nera o bianca. Le composizioni sono complete di tutti gli elementi necessari all'uso, driver dimmerabile 1-10V.

FR

Avec DESK MATRIX, le Linescapes System est désormais préconfiguré avec des formes rectangulaires et carrées, à la fois verticales et horizontales, éclairées en continu, afin de compléter un nombre théoriquement infini de tailles de tables ou de solutions intérieures. 2700K ou 3000K, en finition noire ou blanche. Les compositions sont équipées de tous les éléments nécessaires au travail, driver dimmable 1-10V et étui inclus.

44 x 44 CM

<i>voltage/current</i>	<i>max power</i>	<i>source</i>	<i>flux</i>	<i>version</i>	<i>CRI</i>	<i>switching</i>	<i>CCT</i>	<i>finish</i>	<i>code</i>		
110/240V	24W	linear LED	1340lm	vertical	85	dimmable 1-10V	2700K	white	LSV LW2 51		
								black	LSV LN2 51		
								3000K	white	LSV LW3 51	
								black	LSV LN3 51		
								horizontal	2700K	white	LSH LW2 51
									black	LSH LN2 51	
				3000K			white		LSH LW3 51		
				black			LSH LN3 51				

note

orientable lighting bars 360°, driver included, adjustable cable length 3m, power supply 29x5x5cm included, DALI version on request

☐ IP20

64 x 44 CM

<i>voltage/current</i>	<i>max power</i>	<i>source</i>	<i>flux</i>	<i>version</i>	<i>CRI</i>	<i>switching</i>	<i>CCT</i>	<i>finish</i>	<i>code</i>		
110/240V	31W	linear LED	1870lm	vertical	85	dimmable 1-10V	2700K	white	LSV LW2 55		
								black	LSV LN2 55		
								3000K	white	LSV LW3 55	
								black	LSV LN3 55		
								horizontal	2700K	white	LSH LW2 55
									black	LSH LN2 55	
				3000K			white		LSH LW3 55		
				black			LSH LN3 55				

note

orientable lighting bars 360°, driver included, adjustable cable length 3m, power supply 29x5x5cm included, DALI version on request

☐ IP20



orientable lighting bars 360°



method of assembly



178x64cm, matte black finish

114 x 44 CM

<i>voltage/current</i>	<i>max power</i>	<i>source</i>	<i>flux</i>	<i>version</i>	<i>CRI</i>	<i>switching</i>	<i>CCT</i>	<i>finish</i>	<i>code</i>	
110/240V	50W	linear LED	2920lm	vertical	85	dimmable 1-10V	2700K	white	LSV LW2 58	
								black	LSV LN2 58	
							3000K	white	LSV LW3 58	
								black	LSV LN3 58	
							horizontal	2700K	white	LSH LW2 58
									black	LSH LN2 58
				3000K	white	LSH LW3 58				
					black	LSH LN3 58				

note orientable lighting bars 360°, driver included, adjustable cable length 3m, power supply 29x5x5cm included, DALI version on request

IP20

178 x 44

<i>voltage/current</i>	<i>max power</i>	<i>source</i>	<i>flux</i>	<i>version</i>	<i>CRI</i>	<i>switching</i>	<i>CCT</i>	<i>finish</i>	<i>code</i>	
110/240V	78W	linear LED	4200lm	vertical	85	dimmable 1-10V	2700K	white	LSV LW2 5A	
								black	LSV LN2 5A	
							3000K	white	LSV LW3 5A	
								black	LSV LN3 5A	
							horizontal	2700K	white	LSH LW2 5A
									black	LSH LN2 5A
				3000K	white	LSH LW3 5A				
					black	LSH LN3 5A				

note orientable lighting bars 360°, driver included, adjustable cable length 3m, power supply 25x5,5x7cm included, DALI version on request

IP20

64 x 64 CM

<i>voltage/current</i>	<i>max power</i>	<i>source</i>	<i>flux</i>	<i>version</i>	<i>CRI</i>	<i>switching</i>	<i>CCT</i>	<i>finish</i>	<i>code</i>	
110/240V	38W	linear LED	2400lm	vertical	85	dimmable 1-10V	2700K	white	LSV LW2 52	
								black	LSV LN2 52	
							3000K	white	LSV LW3 52	
								black	LSV LN3 52	
							horizontal	2700K	white	LSH LW2 52
									black	LSH LN2 52
				3000K	white	LSH LW3 52				
					black	LSH LN3 52				

note orientable lighting bars 360°, driver included, adjustable cable length 3m, power supply 29x5x5cm included, DALI version on request

IP20

114 x 64 CM

<i>voltage/current</i>	<i>max power</i>	<i>source</i>	<i>flux</i>	<i>version</i>	<i>CRI</i>	<i>switching</i>	<i>CCT</i>	<i>finish</i>	<i>code</i>	
110/240V	57W	linear LED	3450lm	vertical	85	dimmable 1-10V	2700K	white	LSV LW2 56	
								black	LSV LN2 56	
							3000K	white	LSV LW3 56	
								black	LSV LN3 56	
							horizontal	2700K	white	LSH LW2 56
									black	LSH LN2 56
				3000K	white	LSH LW3 56				
					black	LSH LN3 56				

note orientable lighting bars 360°, driver included, adjustable cable length 3m, power supply 29x5x5cm included, DALI version on request

IP20



178 x 64 CM

<i>voltage/current</i>	<i>max power</i>	<i>source</i>	<i>flux</i>	<i>version</i>	<i>CRI</i>	<i>switching</i>	<i>CCT</i>	<i>finish</i>	<i>code</i>	
110/240V	85W	linear LED	4730lm	vertical	85	dimmable 1-10V	2700K	white	LSV LW2 59	
								black	LSV LN2 59	
							3000K	white	LSV LW3 59	
								black	LSV LN3 59	
							horizontal	2700K	white	LSH LW2 59
									black	LSH LN2 59
				3000K	white	LSH LW3 59				
					black	LSH LN3 59				

note orientable lighting bars 360°, driver included, adjustable cable length 3m, power supply 25x5,5x7cm included, DALI version on request

IP20

114 x 114 CM

<i>voltage/current</i>	<i>max power</i>	<i>source</i>	<i>flux</i>	<i>version</i>	<i>CRI</i>	<i>switching</i>	<i>CCT</i>	<i>finish</i>	<i>code</i>	
110/240V	76W	linear LED	4500lm	vertical	85	dimmable 1-10V	2700K	white	LSV LW2 53	
								black	LSV LN2 53	
							3000K	white	LSV LW3 53	
								black	LSV LN3 53	
							horizontal	2700K	white	LSH LW2 53
									black	LSH LN2 53
				3000K	white	LSH LW3 53				
					black	LSH LN3 53				

note orientable lighting bars 360°, driver included, adjustable cable length 3m, power supply 25x5,5x7cm included, DALI version on request

IP20

178 x 114 CM

<i>voltage/current</i>	<i>max power</i>	<i>source</i>	<i>flux</i>	<i>version</i>	<i>CRI</i>	<i>switching</i>	<i>CCT</i>	<i>finish</i>	<i>code</i>	
110/240V	104W	linear LED	5780lm	vertical	85	dimmable 1-10V	2700K	white	LSV LW2 57	
								black	LSV LN2 57	
							3000K	white	LSV LW3 57	
								black	LSV LN3 57	
							horizontal	2700K	white	LSH LW2 57
									black	LSH LN2 57
				3000K	white	LSH LW3 57				
					black	LSH LN3 57				

note orientable lighting bars 360°, driver included, adjustable cable length 3m, power supply 31x8x6cm included, DALI version on request

IP20

178 x 178 CM

<i>voltage/current</i>	<i>max power</i>	<i>source</i>	<i>flux</i>	<i>version</i>	<i>CRI</i>	<i>switching</i>	<i>CCT</i>	<i>finish</i>	<i>code</i>	
110/240V	132W	linear LED	7060lm	vertical	85	dimmable 1-10V	2700K	white	LSV LW2 54	
								black	LSV LN2 54	
							3000K	white	LSV LW3 54	
								black	LSV LN3 54	
							horizontal	2700K	white	LSH LW2 54
									black	LSH LN2 54
				3000K	white	LSH LW3 54				
					black	LSH LN3 54				

note orientable lighting bars 360°, driver included, adjustable cable length 3m, power supply 31x8x6cm included, DALI version on request

IP20



desk matrix composition, matte black finish

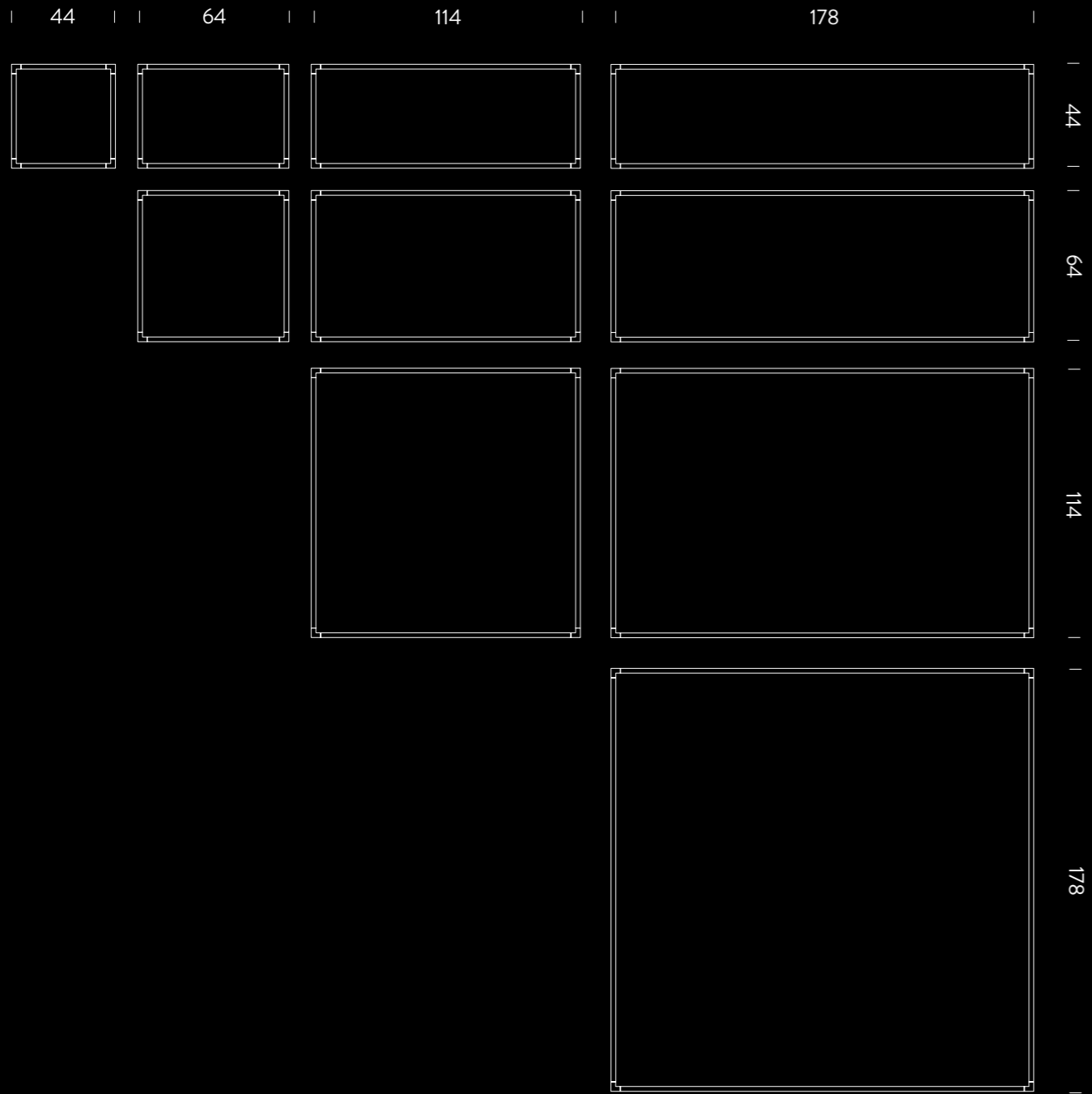



FIX 100°

“The essence of the harmonious link between space and light.”

ENG

An addition to the FIX collection with new glass lenses for a more defined light beam. Wall lamp in die-cast aluminum, available in different finishes: matte white, matte black, matte gold and burnished gold.

DEU

Eine Erweiterung der FIX-Kollektion mit neuen Linsenoptiken für einen noch definierten Lichtstrahl. Wandleuchte aus Aluminiumdruckguss, erhältlich in verschiedenen Farbausführungen: matte-weiß, matte-schwarz, matte-gold und gold brüniert.

ITA

La collezione FIX si amplia con una nuova versione con lenti di vetro per un fascio di luce più definito. Lampada da parete in alluminio pressofuso, disponibile in diverse finiture: bianco opaco, nero opaco, oro opaco e oro brunito.

FR

La famille FIX s'agrandit avec des nouvelles lentilles en verre pour un faisceau de lumière plus défini. Applique en aluminium moulé, disponible en diverses finitions : blanc mat, noir mat, doré mat ou doré bruni.



matte white finish

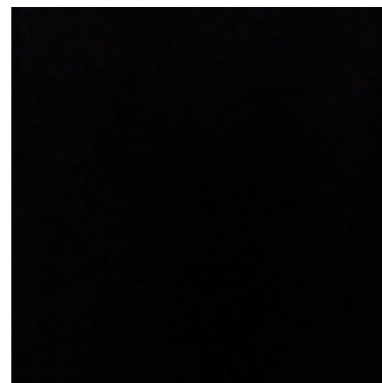

matte black finish



matte gold finish



burnished gold finish

FIX DOUBLE EMISSION

<i>voltage/current</i>	<i>max power</i>	<i>source</i>	<i>flux</i>	<i>emission</i>	<i>optic</i>	<i>switching</i>	<i>CCT</i>	<i>finish</i>	<i>code</i>
230V	2x6W	LED board	2x380lm	up + down	180°	dimmable TRIAC	2700K	matte white	FIM LWW 3A
								matte black	FIM LNW 3A
								matte gold	FIM LGT 3A
								burnished gold	FIM LGW 3A

note

also available in 120V, CRI 85

FIX DOUBLE EMISSION 100°

<i>voltage/current</i>	<i>max power</i>	<i>source</i>	<i>flux</i>	<i>emission</i>	<i>optic</i>	<i>switching</i>	<i>CCT</i>	<i>finish</i>	<i>code</i>
230V	2x6W	LED board	2x524lm	up + down	100°	dimmable TRIAC	2700K	matte white	FIM LWW 3C
								matte black	FIM LNW 3C
								matte gold	FIM LGT 3C
								burnished gold	FIM LGW 3C

note

also available in 120V, CRI 85



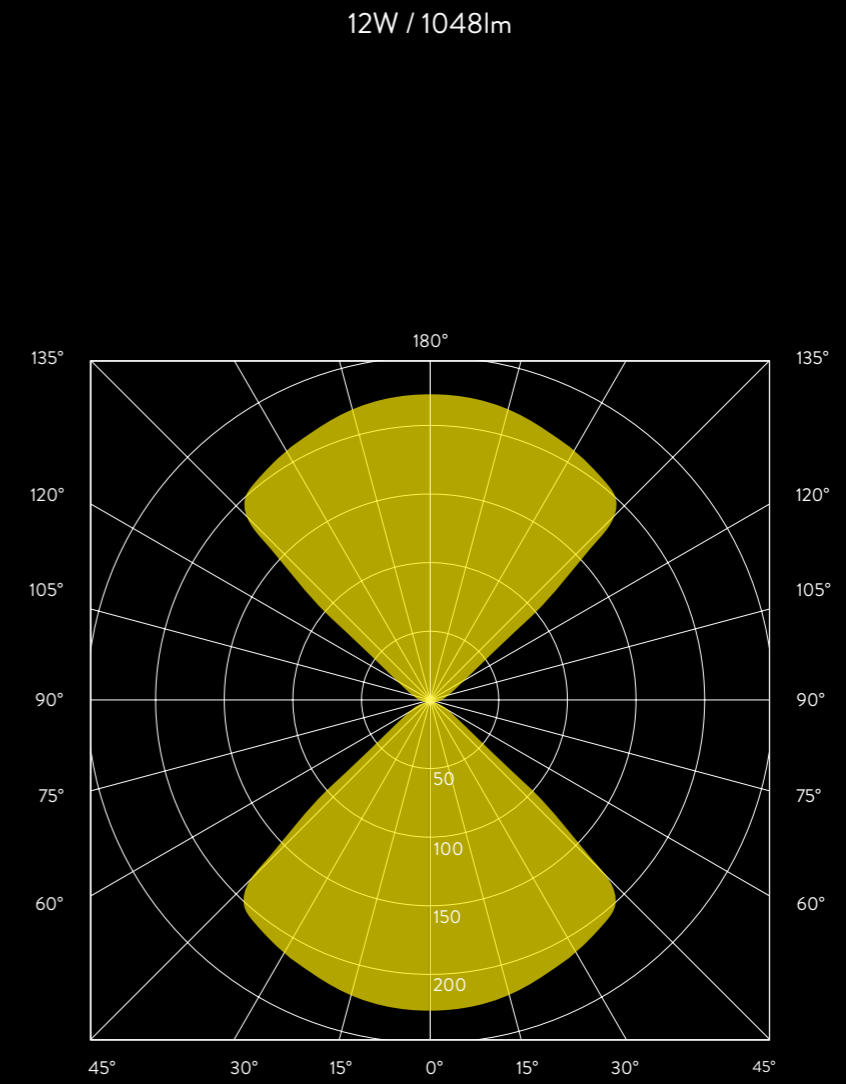
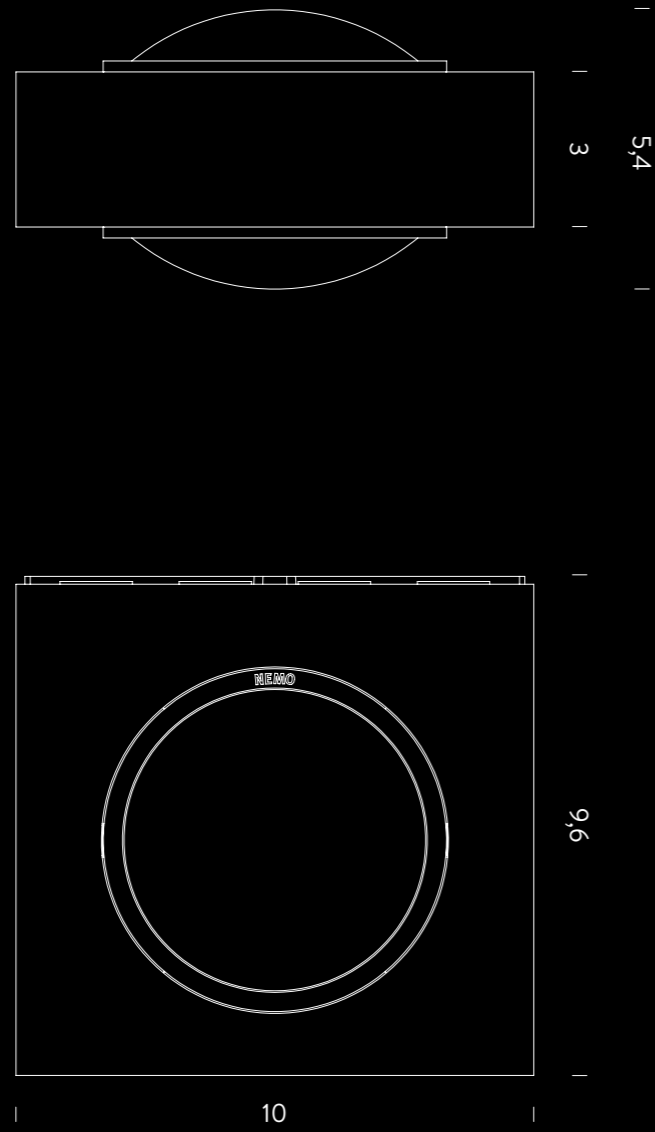

CO / C180 cd / 1000lm



ARA DIM TO WARM | ILARIA MARELLI

“A slit of light in a monolithic mass: the contrast between material and immaterial, the basis of all lighting project”.

ENG

ARA DIM TO WARM, the legendary collection now as the first DIM TO WARM floor lamp, in extruded aluminum with a double light emission: top LED board for a diffused light effect and a 340° orientable side linear LED. Available in different finishes: white/white, anthracite/anthracite, champagne/polished, moka/polished and anthracite/polished.

DEU

ARA DIM TO WARM, die ikonische Stehleuchte aus stranggepresstem Aluminium erstmals mit doppelter DIM TO WARM Emission: Das Uplight-Element auf der Oberseite der Struktur streut ein diffuses Licht an die Decke, während das seitliche LED-Drehelement je nach Wunsch um 340° frei orientiert werden kann. In unterschiedlichen Oberflächen erhältlich: Weiß/Weiß, Anthrazit/Anthrazit, Champagner/Poliert, Moka/Poliert und Anthrazit/Poliert.

ITA

ARA DIM TO WARM, la prima lampada da terra dell'omonima leggendaria collezione con tecnologia DIM TO WARM, in alluminio estruso e con doppia emissione: una sorgente LED superiore per un effetto di luce diffusa e un LED laterale orientabile a 340°. Disponibile in diverse finiture: bianco/bianco, antracite/antracite, champagne/lucido, moka/lucido e antracite/lucido.

FR

ARA DIM TO WARM, une famille désormais légendaire et le premier lampadaire DIM TO WARM, en aluminium extrudé à double émission lumineuse : LED board supérieur pour un effet de lumière diffuse et LED linéaire latéral orientable à 340°. Disponible en différentes finitions : blanc/blanc, anthracite/anthracite, champagne/poli, moka/poli et anthracite/poli.



top LED board

ARA LED**LED+LED**

voltage/current	max power	source	flux	CRI	switching	CCT	finish	code
230V	23+40W	LED board - linear LED	1820 + 3060lm	83	double, dimmable	2700-3000K	white/white	ARA TWW 2B
							anthracite/anthracite	ARA TXX 2B
							white/polished	ARA TWL 2B
							champagne/polished	ARA TDL 2B
							anthracite/polished	ARA TXL 2B
							moka/polished	ARA TML 2B

note

orientable side diffuser, anthracite RAL7016, champagne RAL9007, cable length 3m, DALI on request, dimmer on cable, materials: aluminum+PMMA 3000K (side emission), 2700K (top emission)

**ARA DTW****LED+LED**

voltage/current	max power	source	flux	CRI	switching	CCT	finish	code
220/240V	27+45W	LED board - linear LED	2390 + 3426lm	83	double, dim to warm	2200-3000K	white/white	ARA LWW 24
							anthracite/anthracite	ARA LXX 24
							champagne/polished	ARA LDL 24
							anthracite/polished	ARA LXL 24
							moka/polished	ARA LML 24

note

orientable side diffuser, anthracite RAL7016, champagne RAL9007, materials: aluminum+PMMA, cable length 3m, 3000K (max), 2200K (min)



dim to warm control on board



340° rotation

Colour temperature is linked to the light intensity, DIM TO WARM is the technology that acts to modify it through a dimming process, smoothly transitioning from vivid white to soft warm, thus creating controlled scenarios that mimic natural light and respond to various needs of daily activities.

DIM TO WARM technology provides the right light, in the right way at the right time.

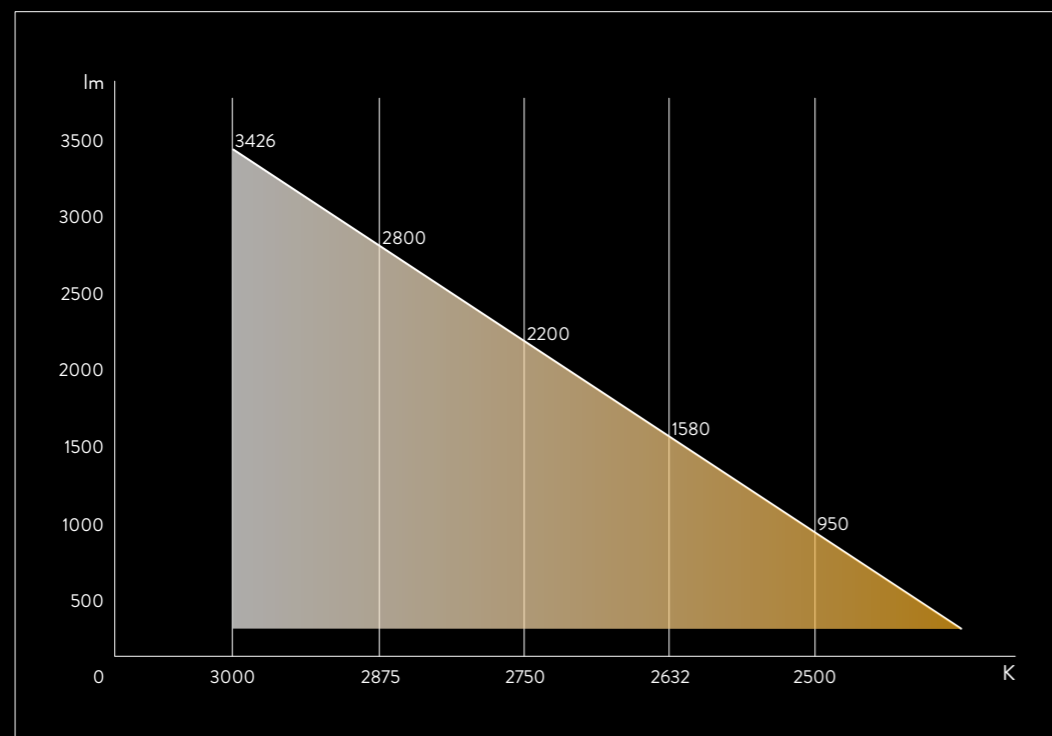

DTW example: top LED board dimmed 2200K | side linear LED dimmed 3000K



from left to right: white/white, champagne/polished

moka/polished, anthracite/polished , anthracite/anthracite

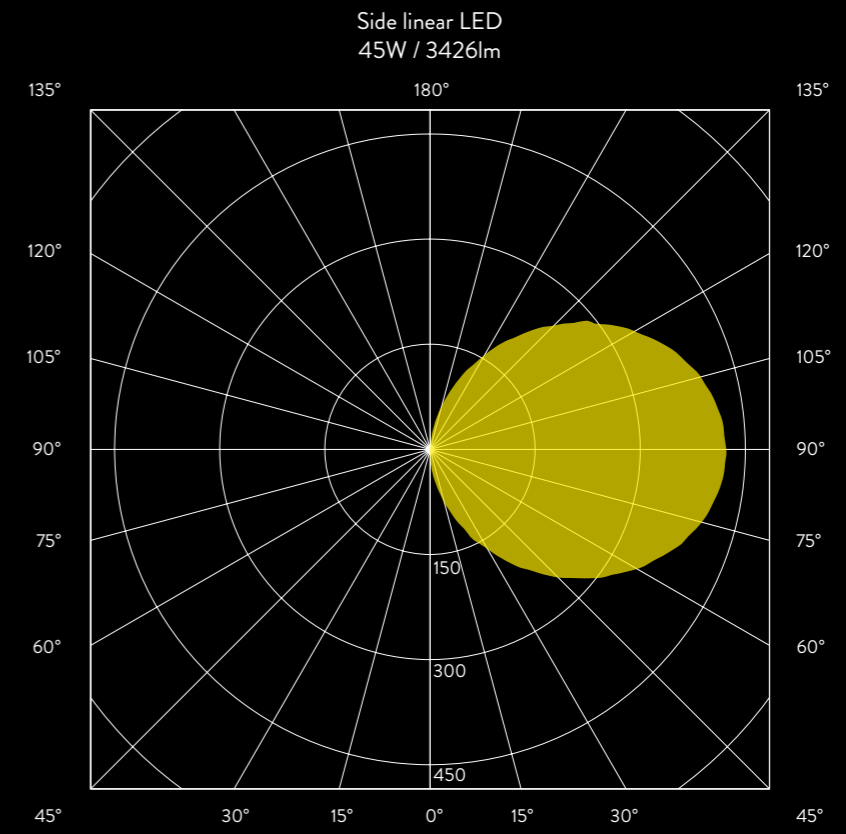
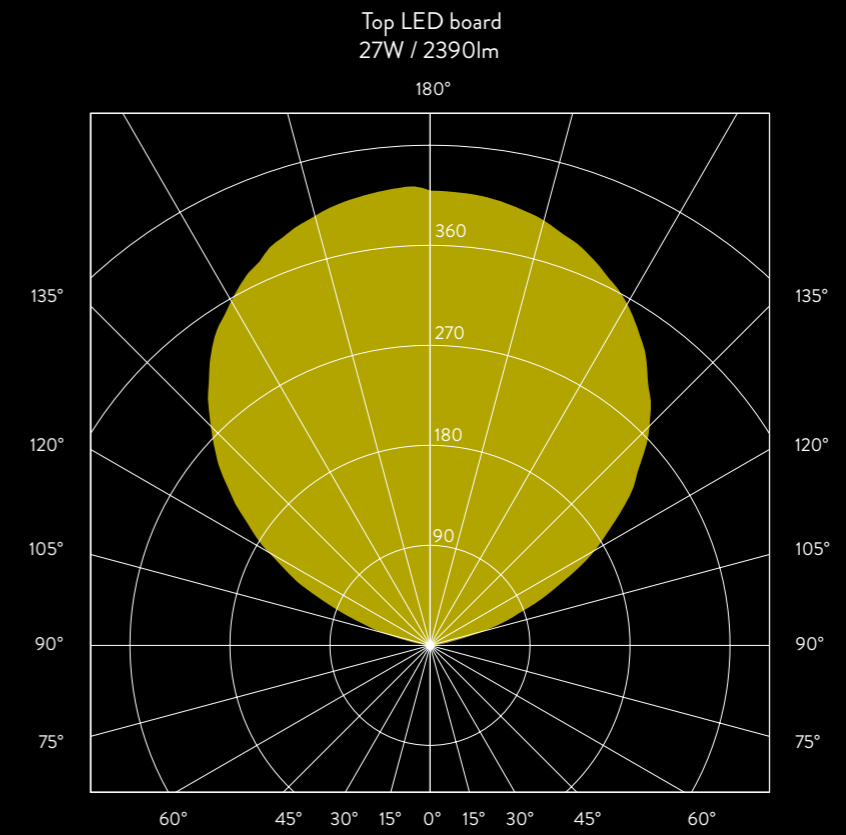
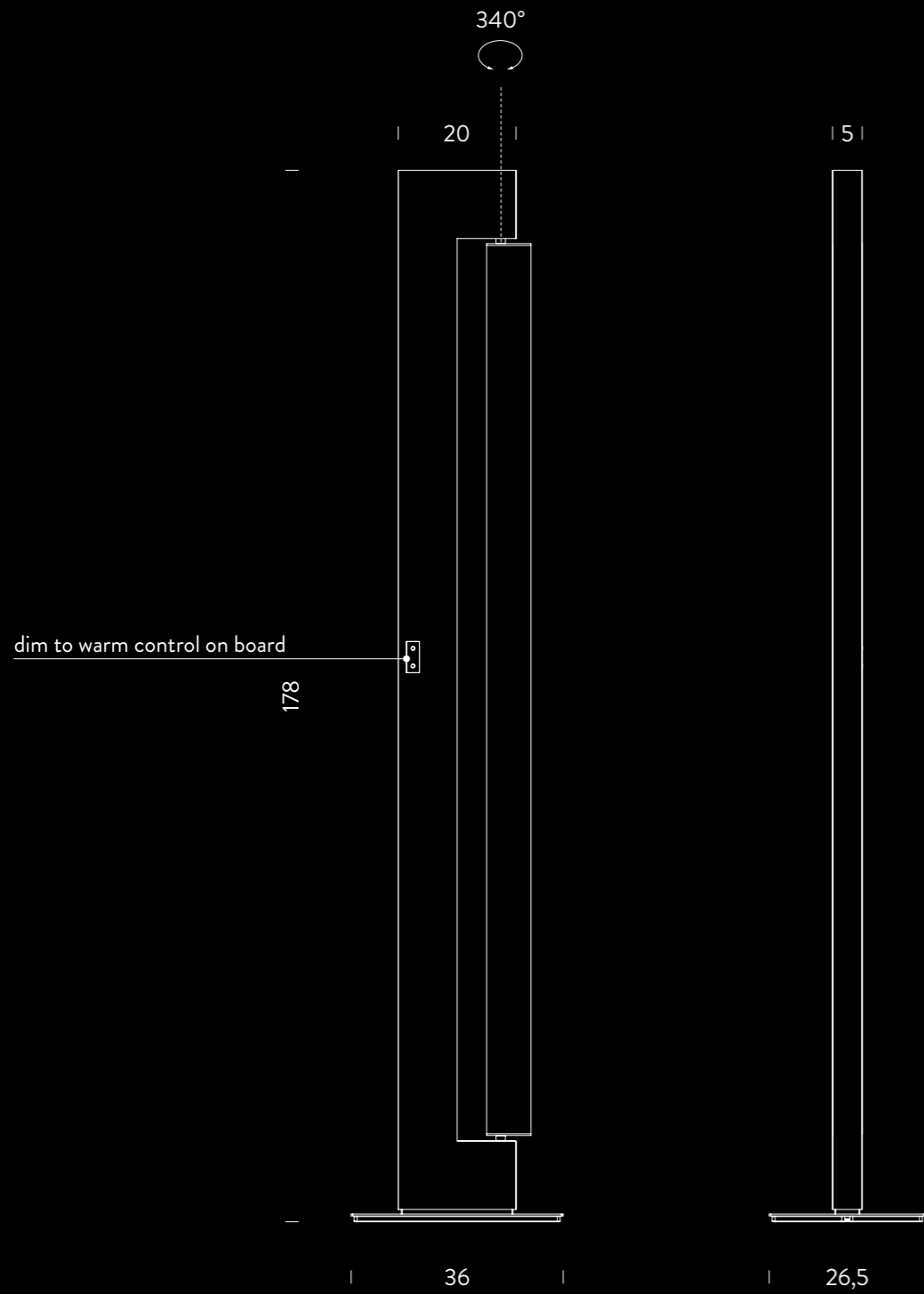

CO / C180 cd / 1000lm

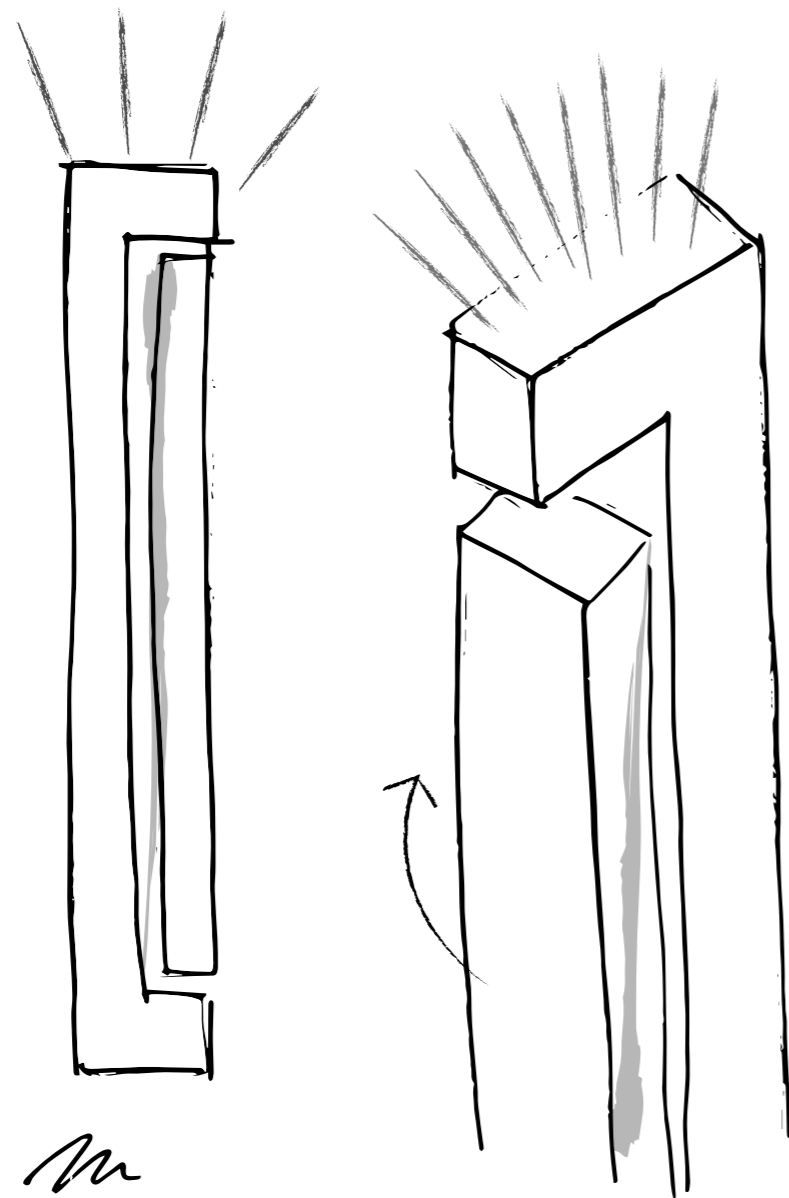

M

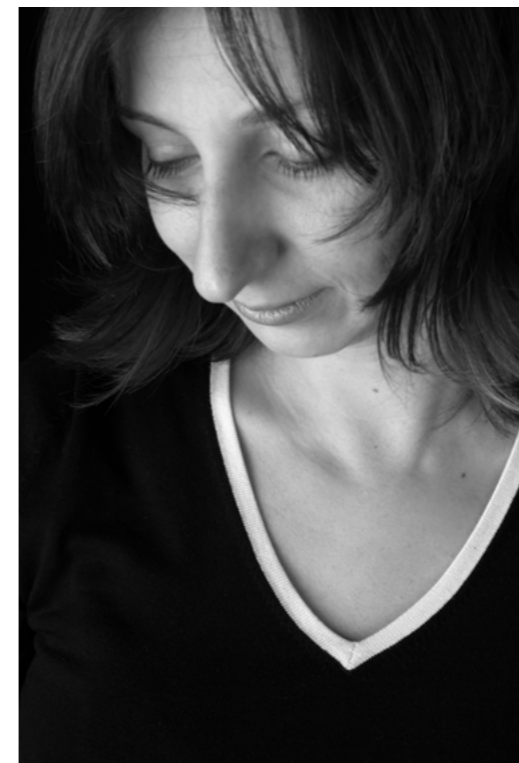

Italian architect and designer, Ilaria Marelli founded her studio in 2004, which she defines as a true laboratory of ideas, through which she works on art direction, product design, interior and set design.

Interested in the social and cultural aspects of the industry, Ilaria Marelli teaches “Innovation design” at Politecnico di Milano, and promotes ideas on social innovation, such as the first Italian co-housing project.

NEMOSTUDIO



PLINT | NEMO STUDIO | MASSIMO COLAGRANDE

“The human paradigm of architectural lighting”.

ENG

PLINT is a LED spot that bursts into the world of accent lighting, challenging the notions of conventional spotlights with its flexibility of installation and excellent light quality. The integrated design of the high-performing spot with variable optics in a solid metal structure allow PLINT to be freely positioned for optimal and precise, yet discreet accent lighting. On-board dimming and the vast adjustability possibilities of PLINT's light emission make it a versatile and innovative tool for any project. Available in matte black finish and in two different colour temperatures.

DEU

PLINT ist ein LED-Spot, der in die Welt der Akzentbeleuchtung einbricht und mit seiner Flexibilität bei der Installation und seiner exzellenten Lichtqualität die Vorstellungen von herkömmlichen Strahlern herausfordert. Das integrierte Design des leistungsstarken Spots mit variabler Optik in einer soliden Metallstruktur ermöglicht die freie Positionierung von PLINT für eine optimale und präzise, aber dennoch diskrete Akzentbeleuchtung. Die integrierte Dimmbarkeit und die umfangreichen Einstellmöglichkeiten der Lichtabstrahlung machen PLINT zu einem vielseitigen und innovativen Instrument für die Akzentbeleuchtung. Erhältlich in mattschwarzer Ausführung und in zwei verschiedenen Farbtemperaturen.

ITA

PLINT è uno spot a LED che irrompe nel mondo dell'illuminazione d'accento invertendone il paradigma, grazie ad un'elevata flessibilità di posizionamento. Racchiude al suo interno design e contenuto tecnologico consentendo un'illuminazione discreta e al tempo stesso precisa. All'interno di una struttura metallica è integrato uno spot ad alte prestazioni con ottica variabile con zoom on-board, che ne permette la regolazione del fascio di luce. L'orientabilità del faretto direziona l'emissione luminosa a seconda delle specifiche necessità. PLINT è proposto con finitura nera e con due differenti temperature colore. Il dimmer on-board inoltre, permette di modulare l'illuminazione in modo puntuale.

FR

PLINT est un spot à LED qui fait irruption dans le monde de l'éclairage ponctuel, inversant le paradigme grâce à une grande flexibilité d'implantation. Il renferme un contenu design et technologique, permettant un éclairage discret et en même temps précis. A l'intérieur d'une structure métallique est intégré un spot haute performance à optique variable avec zoom embarqué, qui permet le réglage du faisceau lumineux en fonction des besoins spécifiques. PLINT est proposé avec une finition noire et avec deux températures de couleur différentes. Le dimmer intégré permet également de moduler l'éclairage de façon ponctuelle.

PLINT

<i>voltage/current</i>	<i>max power</i>	<i>source</i>	<i>flux</i>	<i>optic</i>	<i>CRI</i>	<i>switching</i>	<i>CCT</i>	<i>finish</i>	<i>code</i>
220/240V	13W	LED	900lm	direct adjustable 15°-55°	90	push dimm on board	2700K	black	PLT LN2 11
							3000K	black	PLT LN3 11

note

driver integrated, adjustable beam 15°-55°, orientable spot 90°, cable length 3m

□ **IP20**

dimming control on board



adjustable beam 15°-55°



orientable spot 90°



black finish



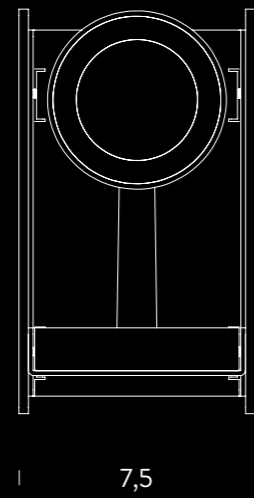
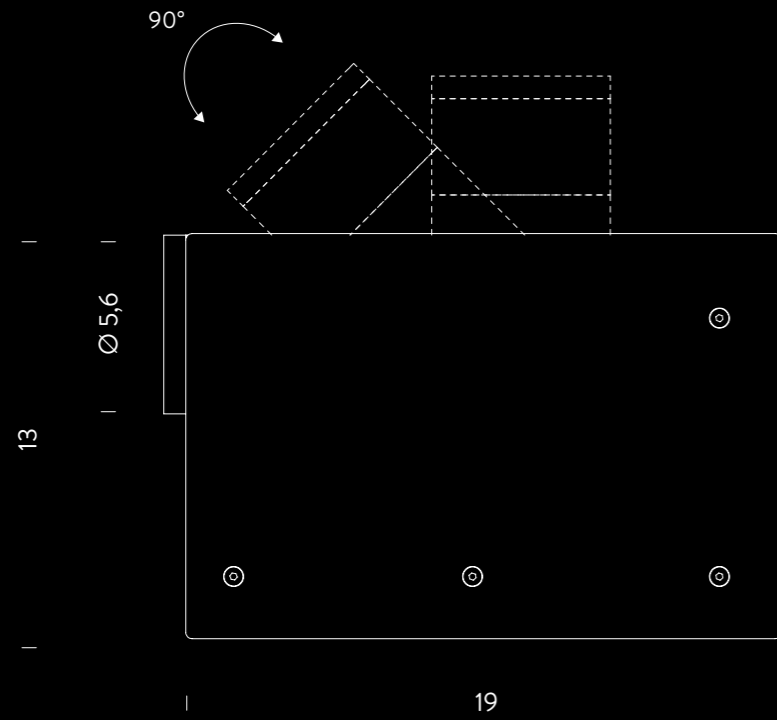

13W / 900lm

Optic 15°

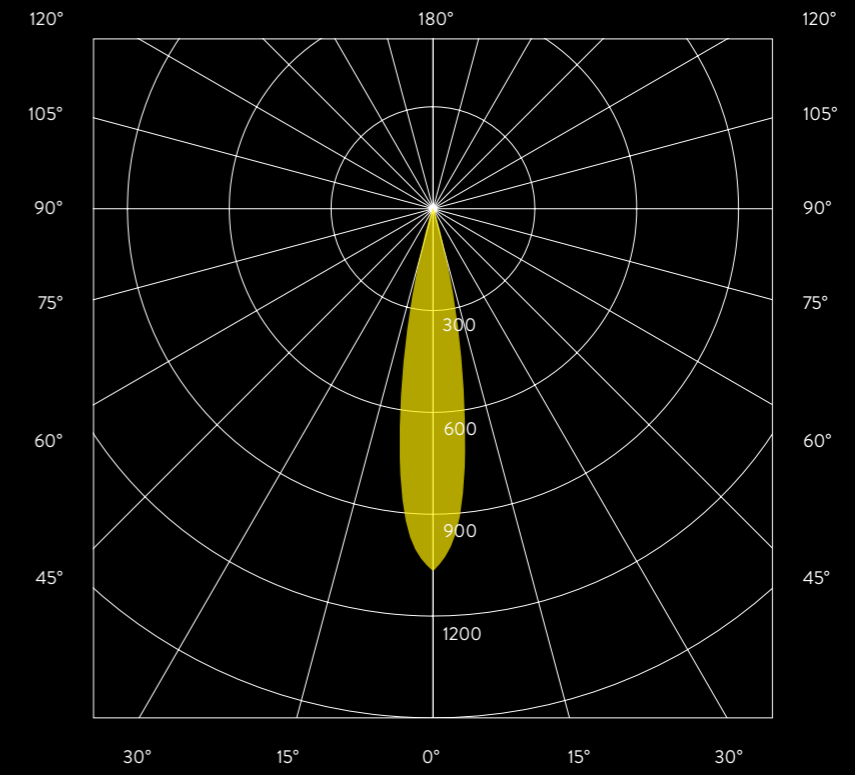

Optic 55°

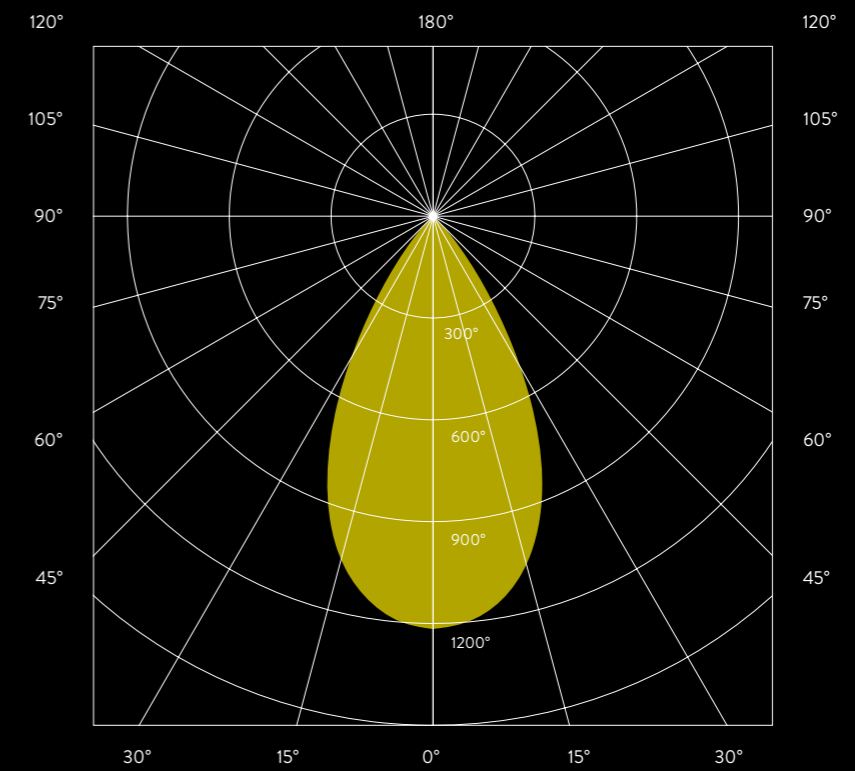

CO / C180 cd / 1000lm

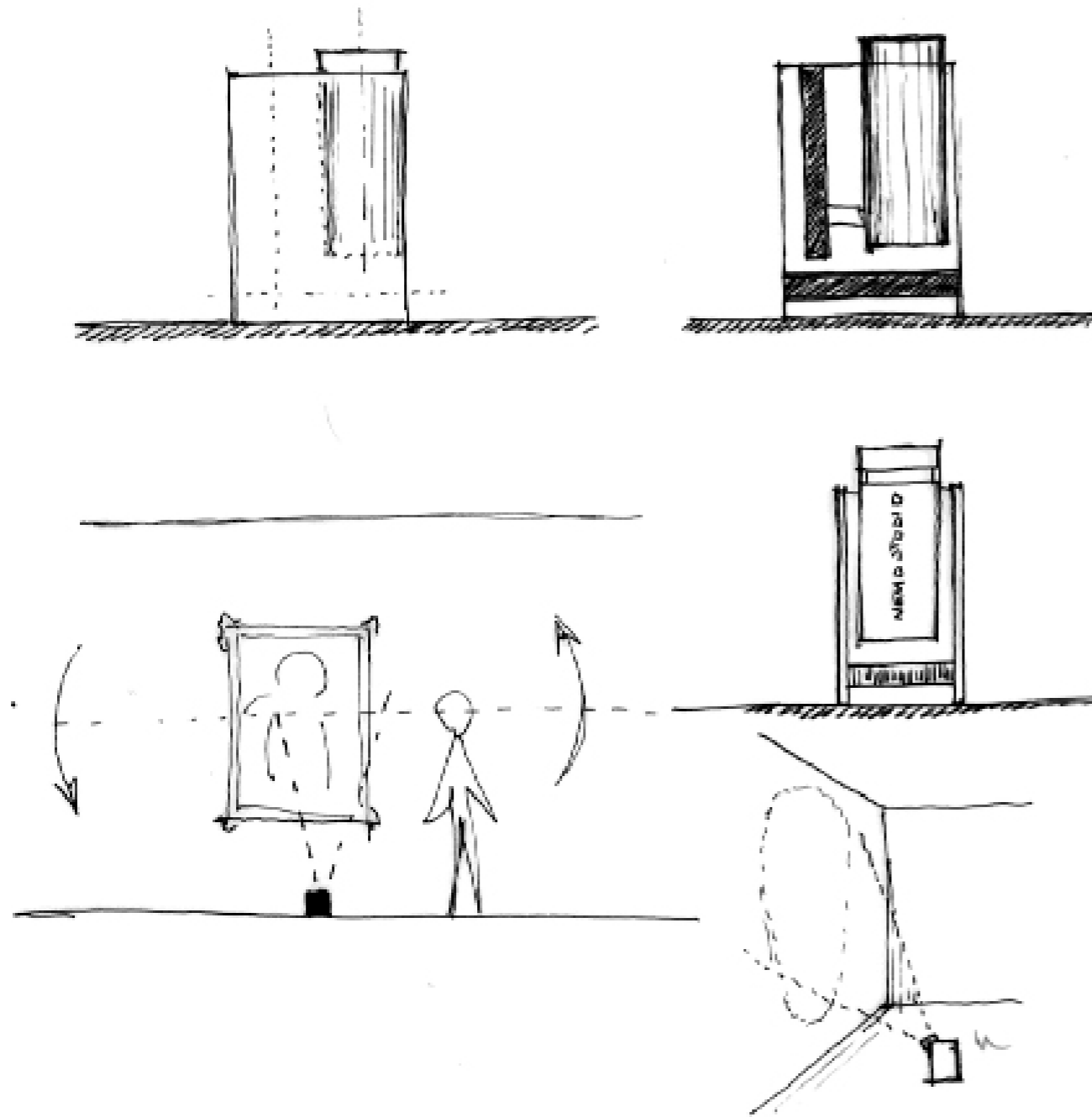

Graduated in Architecture at Politecnico di Milano, Massimo Colagrande (Milan, 1983) began his professional experience with Mario Bellini, before an intense collaboration with Matteo Thun. Since 2017, he has been working with Vincent Van Duysen in Antwerp, Belgium.

Clean lines, simplicity and timelessness are the main features of his architectural approach. He loves to draw geometric volumes and voids carved in materials, to create silent, serene and warm products, where people find shelter.

PLINT inaugurates the collaboration between Colagrande and Nemo.

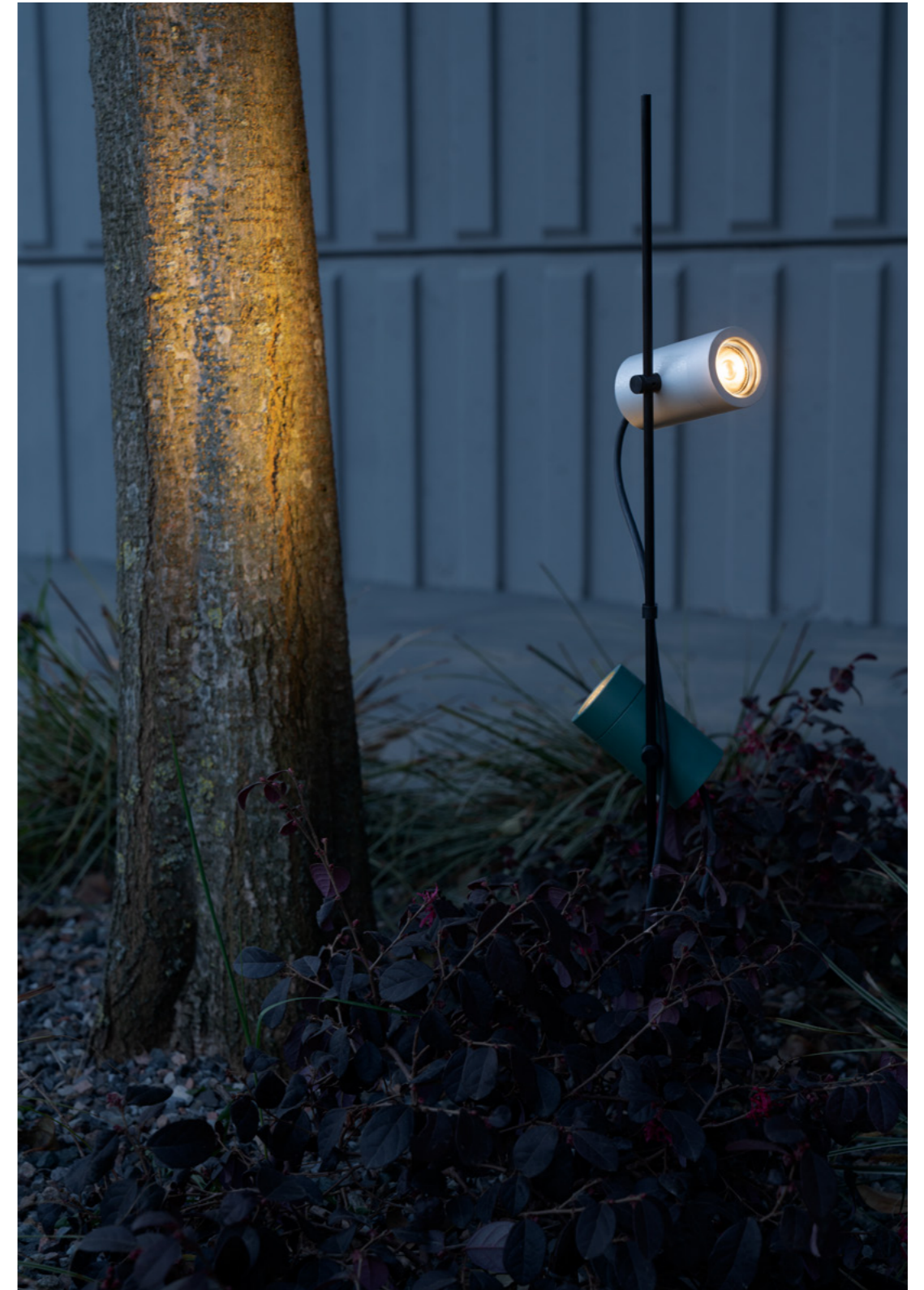

LUX COLLECTION | NEMO STUDIO

“The design-made perfect ally to bring efficient lighting to the natural”.

ENG

LUX GARDEN is part of a collection that includes a high-performance small spots selection, suitable for outdoor applications. Available in different finishes, colour temperatures and beam angles. Dimmable via 1-10V and DALI. Proposed on a special rod for outdoor installations in the ground and is orientable and adjustable, the spot slides on the rod allowing positioning as desired. The product features a colour rendering index higher than 90.

DEU

LUX GARDEN gehört zu einer Kollektion, die eine Hochleistungs-Auswahl an kleinen Spots umfasst, die für Außenanwendungen geeignet sind. Erhältlich in verschiedenen Ausführungen, Farbtemperaturen und Abstrahlwinkeln. Dimmbar über 1-10V und DALI. Der Spot wird auf einer speziellen Stange für die Außenmontage im Boden vorgeschlagen. Der Strahler wird auf ihrer Schiene nach Wunsch positioniert werden. Farbwiedergabeindex > 90.

ITA

LUX GARDEN fa parte di una collezione che comprende una selezione di spots dalle dimensioni ridotte ed alte performance, dedicate all'illuminazione outdoor. Disponibile in diverse finiture, temperature di colore e fasci ottici. Dimmerabili 1-10V e DALI. Orientabile e regolabile nell'installazione nel terreno grazie ad un'apposita asticella: i faretti scorrono sull'asta permettendo il posizionamento a piacere. Indice di resa cromatica superiore a 90.

FR

LUX GARDEN fait partie d'une collection qui comprend une sélection de petits spots très performants, adaptés aux applications extérieures. Disponibles en différentes finitions, températures de couleur et angles de faisceau. Gradable via 1-10V et DALI. Proposé sur une tige spéciale pour les installations. Le spot est orientable et réglable, il glisse sur la tige et peut être positionné à votre discrétion. Le produit présente un indice de rendu des couleurs supérieur à 90.

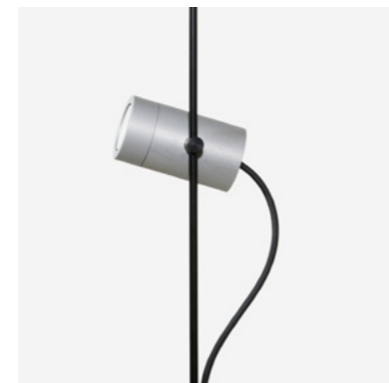

grey finish



green finish



orientable spot

LUX GARDEN

<i>voltage/current</i>	<i>max power</i>	<i>source</i>	<i>flux</i>	<i>mounting</i>	<i>optic</i>	<i>switching</i>	<i>CCT</i>	<i>finish</i>	<i>code</i>
IN 12V - 350mA	4,2W	LED spot	366lm	ground	17°	acc. to driver	3000K	grey	BLUG3001N21WAA
			372lm		46°				BLUG3001F21WAA
			366lm		17°		4000K		BLUG3001N21NAA
			372lm		46°				BLUG3001F21NAA
			366lm		17°		3000K	black	BLUG3001N21WAN
			372lm		46°				BLUG3001F21WAN
			366lm		17°		4000K		BLUG3001N21NAN
			372lm		46°				BLUG3001F21NAN
			366lm		17°		3000K	green	BLUG3001N21WVE
			372lm		46°				BLUG3001F21WVE
			366lm		17°		4000K		BLUG3001N21NVE
			372lm		46°				BLUG3001F21NVE

note

driver not included, cable length 2m, compatible control: 1-10V, DALI, DMX, Casambi, series connection, CRI > 90

customizations

CCT 2700K

◆ IP67

LUX GARDEN DRIVER

<i>version</i>	<i>voltage/current</i>	<i>max power</i>	<i>IP</i>	<i>switching</i>	<i>dimensions cm</i>	<i>code</i>		
for 2 spots	350mA	12W	20	on-off	9,8x3,3x2,2	WALIMLED08350		
for 3 spots		17W				12,2x3,8x2,4	WALIMLED12350	
for 5 spots		15W		dimnable 1-10V	10,3x6,7x2,1	WALI/DIMM/JOLLY		
		16W		67		on/off	14x3x2,2	WALIMLED12350IP
		25W		20			12,4x7,9x2,2	WALI/MAXI/JOLLY

note

for outdoor installation IP connection system not included



ENG

Made of anodized aluminum, LUX S is available with different finishes, colour temperatures, optical beams. 1-10V and DALI dimmable. The body allows you to direct the light according to your needs.

DEU

Die aus eloxiertem Aluminium gefertigte LUX S ist in verschiedenen Ausführungen, Farbtemperaturen, optischen Strahlen und mit 1-10V und DALI dimmbar erhältlich. Der Körper ermöglicht es, das Licht nach Bedarf zu lenken.

ITA

Realizzato in alluminio anodizzato, LUX S è disponibile con differenti finiture, temperature colore, fasci ottici. Dimmerabile 1-10V e DALI. Il corpo permette di direzionare la luce in base alle esigenze.

FR

Fabriqué en aluminium anodisé, LUX S est disponible en différentes finitions, températures de couleur, faisceaux optiques, dimmable 1-10V et DALI. Le corps permet d'orienter la lumière selon vos besoins.



orientable spot

LUX S

<i>voltage/current</i>	<i>max power</i>	<i>source</i>	<i>flux</i>	<i>mounting</i>	<i>optic</i>	<i>switching</i>	<i>CCT</i>	<i>finish</i>	<i>code</i>
IN 12V-350mA	4,2W	LED spot	366lm	surface	17°	according to driver	3000K	grey	BLUS1801N21WAA
			372lm		46°				BLUS1801F21WAA
			366lm	17°	4000K	BLUS1801N21NAA			
			372lm	46°		BLUS1801F21NAA			
			366lm	17°	3000K	black	BLUS1801N21WAN		
			372lm	46°		BLUS1801F21WAN			
			366lm	17°	4000K		BLUS1801N21NAN		
			372lm	46°			BLUS1801F21NAN		

note cable 2m, peg BLUXSPEG not included, driver not included. Compatible control: 1-10V, DALI, DMX, Casambi, series connection, CRI > 90

customizations CCT 2700K

IP67

LUX S DRIVER

<i>version</i>	<i>voltage/current</i>	<i>max power</i>	<i>IP</i>	<i>switching</i>	<i>dimensions cm</i>	<i>code</i>
for 2 spots	350mA	12W	20	ON-OFF	9,8x3,3x2,2	WALIMLED08350
for 3 spots		17W			12,2x3,8x2,4	WALIMLED12350
for 5 spots		15W	67	dimmable 1-10V	10,3x6,7x2,1	WALI/DIMM/JOLLY
		16W		on/off	14x3x2,2	WALIMLED12350IP
		25W			12,4x7,9x2,2	WALI/MAXI/JOLLY

note for outdoor installation IP connection system not included

**ACCESSORIES**

<i>version</i>	<i>finish</i>	<i>dimensions cm</i>	<i>code</i>
PEG for 1 spot	black	19x3x2	BLUXSPEG



ENG

LUX W is a family of spots with wall fixing dedicated to accent and decorative facade lighting. The collection is made of anodized aluminum with natural or black finish. LUX W is proposed with single and double light emission and is available with two different colour temperatures and optical beams. The body of the spots is adjustable during installation and therefore allows you to direct the emission of light as desired. Colour rendering index is greater than 90 and fixing to the wall is done through a base that contains the power supply.

DEU

LUX W ist eine Familie von Wandspots für die Akzent und Dekorationsbeleuchtung von Fassaden. Die Kollektion besteht aus eloxiertem Aluminium mit einer natürlichen oder schwarzen Oberfläche. LUX W ist mit einfachem und doppeltem Lichtaustritt und zwei verschiedenen Farbtemperaturen und Lichtkegeln erhältlich. Die Spots sind bei der Installation verstellbar, so dass der Lichtaustritt nach Wunsch ausgerichtet werden kann. Der Farbwiedergabeindex ist größer als 90 und die Wandmontage erfolgt über einen Sockel, der das Vorschaltgerät enthält.

ITA

LUX W è una famiglia di spots con fissaggio a parete dedicata all'illuminazione d'accento e decorativa di facciate. La collezione è realizzata in alluminio anodizzato con finitura naturale o nero. LUX W è proposto con emissione luminosa singola e doppia ed è disponibile in due diverse temperature colore e con due fasci ottici. Il corpo degli spots è orientabile in fase di installazione e permette quindi di direzionare l'emissione di luce a piacere. Indice di resa cromatica è maggiore di 90 e il fissaggio a parete avviene tramite una base che contiene l'alimentatore.

FR

LUX W est une famille de spots à fixation murale dédiée à l'éclairage ponctuel et décoratif de façade. La collection est faite en aluminium anodisé avec une finition naturelle ou noire. LUX W est proposé avec une émission lumineuse simple et double et est disponible avec deux températures de couleur et faisceaux optiques différents. Le corps des spots est orientable en phase d'installation et permet donc de diriger l'émission de lumière à souhait. L'indice de rendu des couleurs est supérieur à 90 et la fixation au mur se fait grâce à un socle qui contient l'alimentation.

LUX W-D (DOUBLE)

<i>voltage/current</i>	<i>max power</i>	<i>source</i>	<i>flux</i>	<i>mounting</i>	<i>optic</i>	<i>switching</i>	<i>CCT</i>	<i>finish</i>	<i>code</i>
220/240V	8,4W	LED spot	732lm	wall	17°	on/off	3000K	grey	BLUW4102N21WAA
			744lm		46°				BLUW4102F21WAA
			732lm		17°		4000K		BLUW4102N21NAA
			744lm		46°				BLUW4102F21NAA
			732lm		17°		3000K	black	BLUW4102N21WAN
			744lm		46°				BLUW4102F21WAN
			732lm		17°		4000K		BLUW4102N21NAN
			744lm		46°				BLUW4102F21NAN

note

driver included, combination of different optics on demand, CRI > 90

 **IP65**

black finish



grey finish

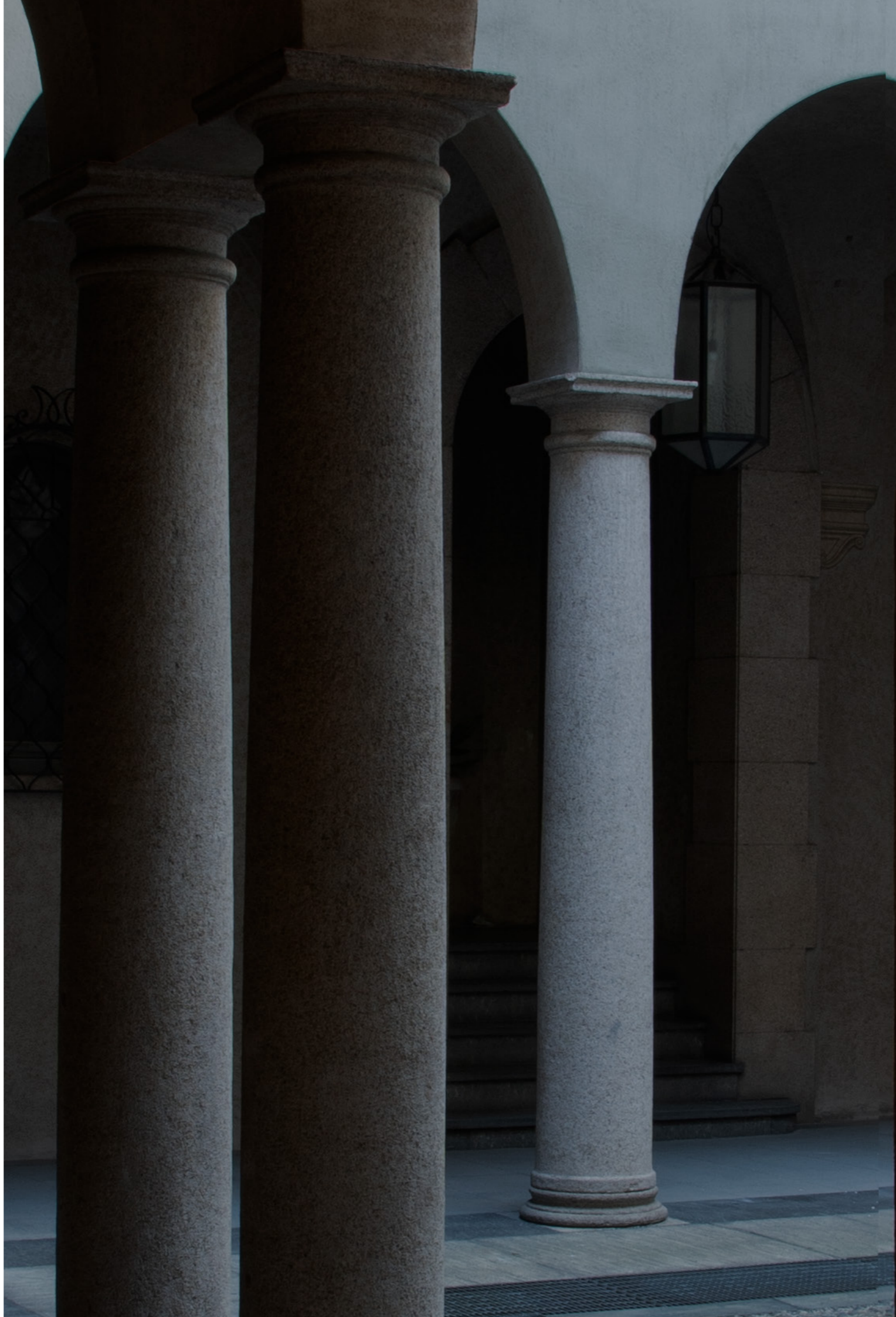

grey finish

LUX W-S (SINGLE)

<i>voltage/current</i>	<i>max power</i>	<i>source</i>	<i>flux</i>	<i>mounting</i>	<i>optic</i>	<i>switching</i>	<i>CCT</i>	<i>finish</i>	<i>code</i>
220/240V	4,2W	LED spot	366lm	wall	17°	on/off	3000K	grey	BLUW4101N21WAA
			372lm		46°				BLUW4101F21WAA
			366lm	wall	17°	on/off	4000K	grey	BLUW4101N21NAA
			372lm		46°				BLUW4101F21NAA
			366lm	wall	17°	on/off	3000K	black	BLUW4101N21WAN
			372lm		46°				BLUW4101F21WAN
			366lm	wall	17°	on/off	4000K	black	BLUW4101N21NAN
			372lm		46°				BLUW4101F21NAN

note

driver included, CRI > 90

☐ IP65



black finish



grey finish

LUX W-D (DOUBLE)

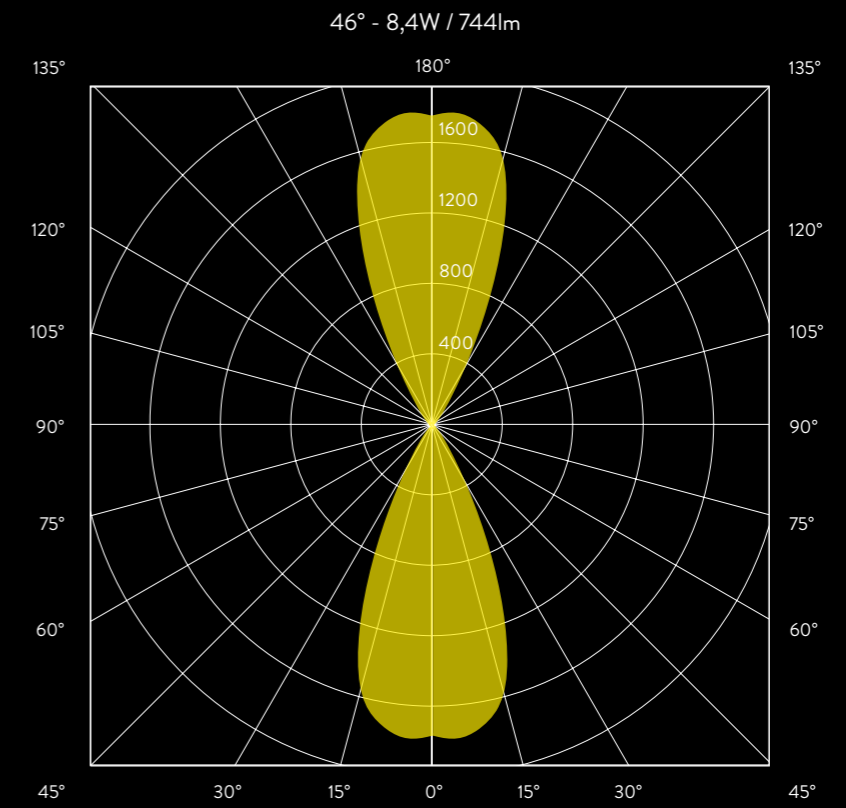
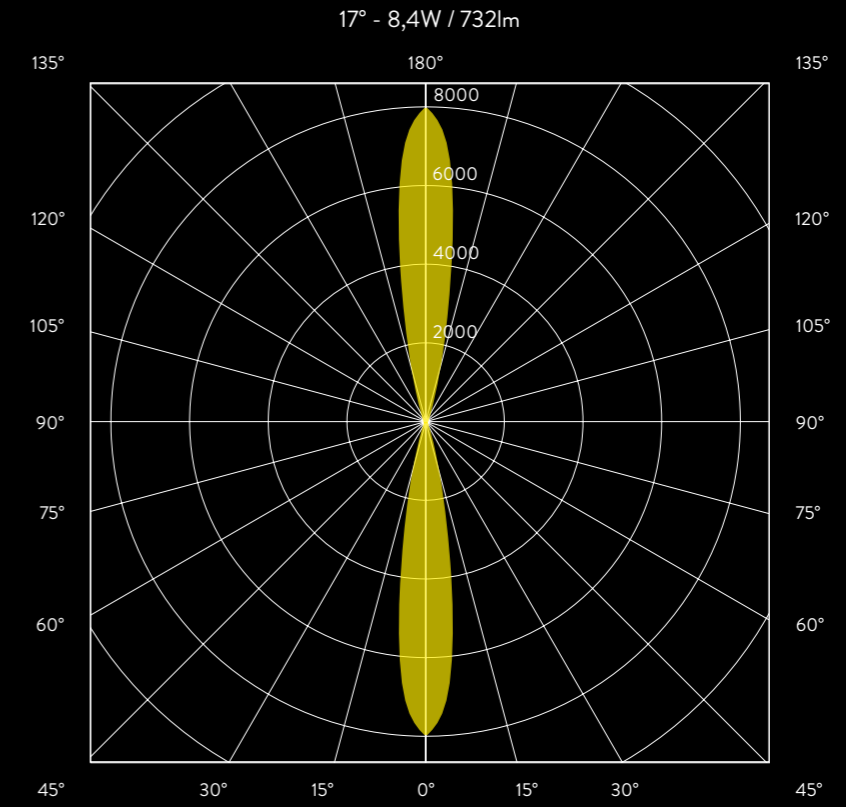
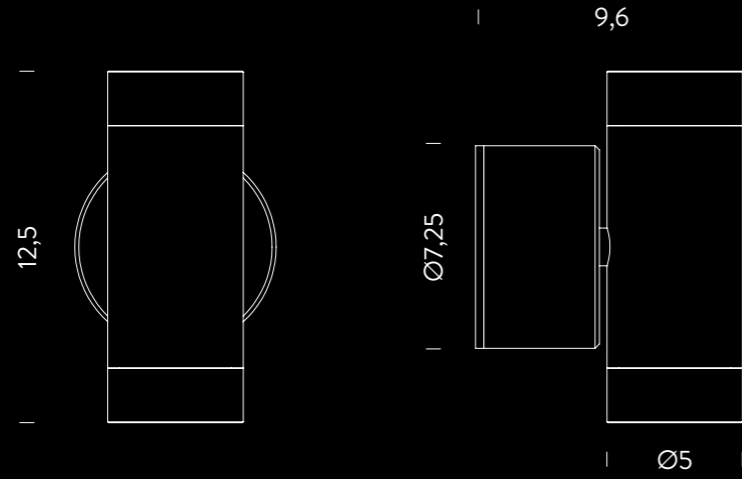

CO / C180 cd / 1000lm



LUX GARDEN

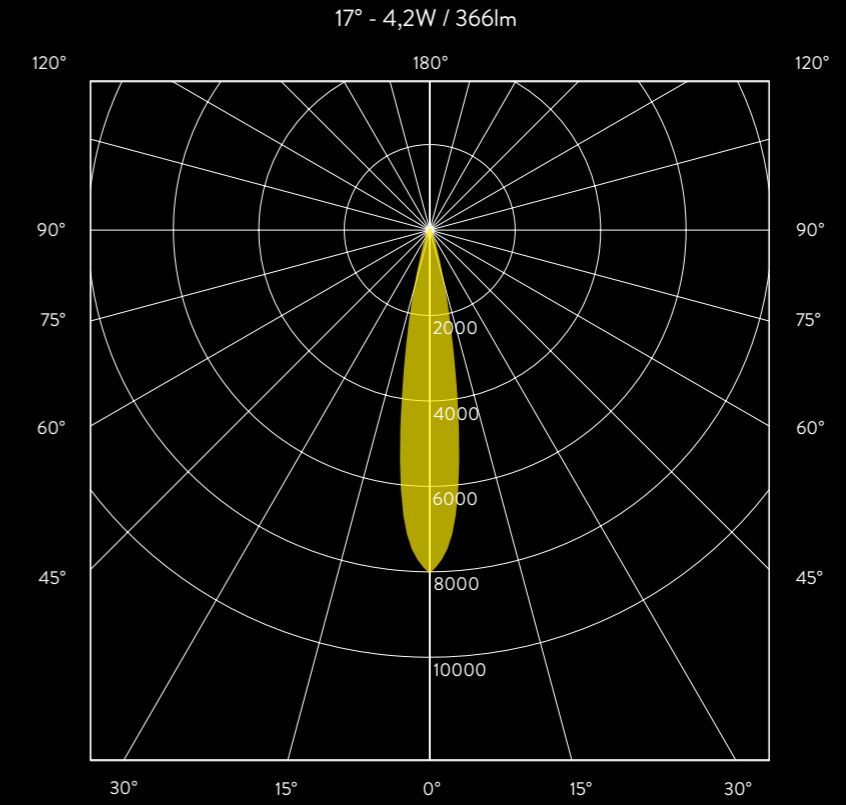
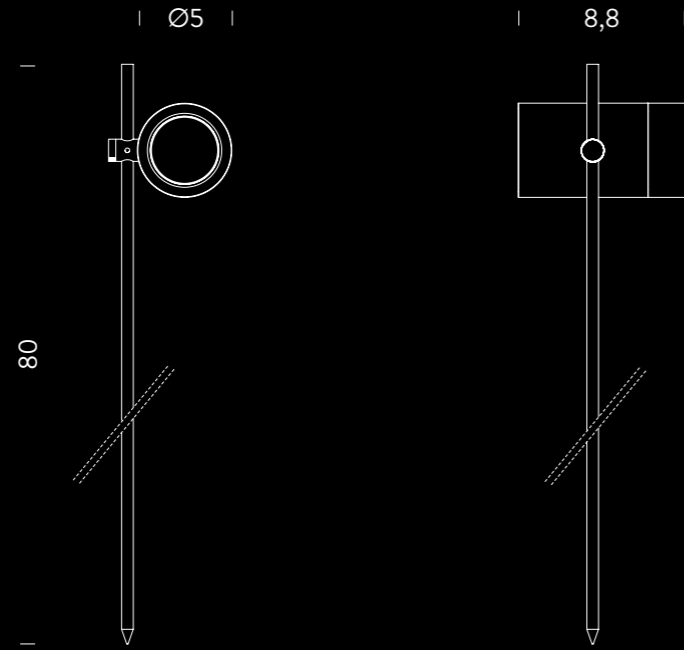

LUX S

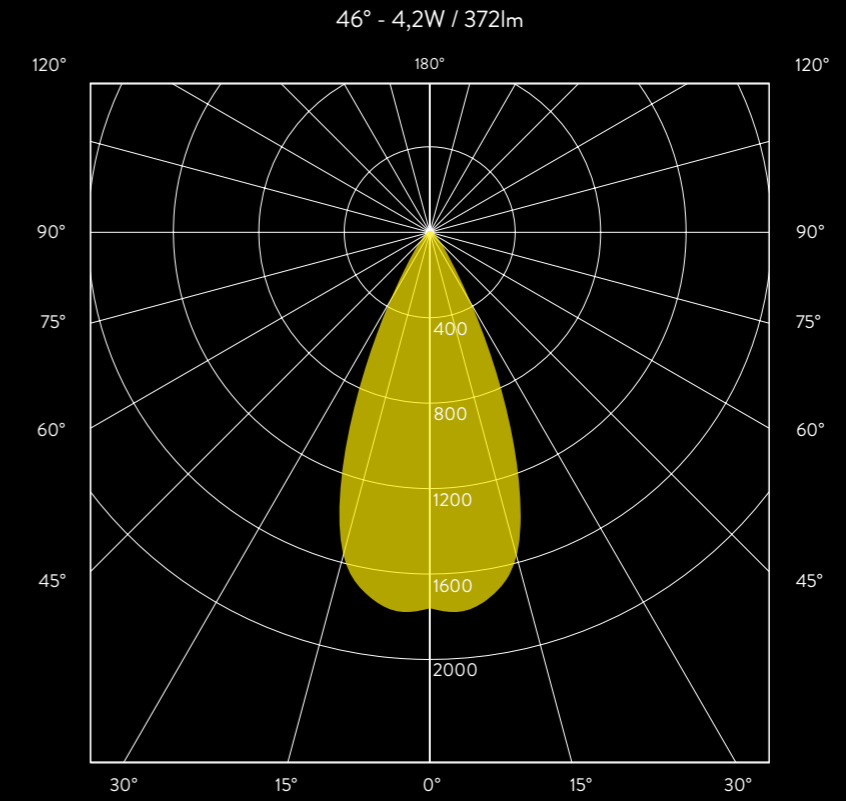

LUX W-S (SINGLE)

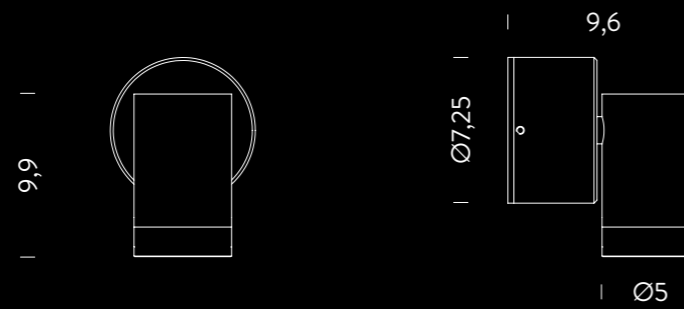

— CO / C180 cd / 1000lm



ZIRKOL LINEAR UGR | NEMO STUDIO

“Uniquely high visual comfort”.

ENG

New lamp of the collection, ZIRKOL LINEAR UGR is equipped with a particular optical unit that allows direct emission with a reduced glare index (UGR <19). Aluminum structure available in two finishes and two colour temperatures. Equipped with ceiling rose and DALI control system, particularly suitable for installation in offices and work environments where high visual comfort is required.

DEU

Die neue Lampe in der Kollektion, ZIRKOL LINEAR UGR ist mit einer speziellen optischen Gruppe ausgestattet, die eine direkte Emission mit einem reduzierten Blendungsindex (UGR <19) ermöglicht. Struktur in Aluminium, erhältlich in zwei Ausführungen und Farbtemperaturen. Ausgestattet mit einem Baldachin und einem DALI-Steuerungssystem ist sie für Büros und Arbeitsplätze geplant, an denen ein hoher Sehkomfort erforderlich ist.

ITA

Nuova lampada della collezione, ZIRKOL LINEAR UGR è dotata di un particolare gruppo ottico che permette un'emissione diretta con un ridotto indice di abbagliamento (UGR <19). Struttura in alluminio disponibile in due finiture e due temperature colore. Dotata di rosone e sistema di controllo DALI, è particolarmente adatta all'utilizzo in uffici e in ambienti di lavoro dove è richiesto un elevato comfort visivo.

FR

Nouvelle lampe de la collection, ZIRKOL LINEAR UGR est équipée d'un bloc optique particulier qui permet une émission directe avec un indice d'éblouissement réduit (UGR <19). Structure en aluminium, disponible en deux finitions et deux températures de couleur. Equipée d'une patère et d'un système de contrôle DALI, elle est particulièrement adaptée pour une utilisation dans les bureaux et les environnements de travail où un confort visuel élevé est requis.

ZIRKOL LINEAR UGR**DOWNLIGHT**

<i>voltage/current</i>	<i>max power</i>	<i>source</i>	<i>flux</i>	<i>mounting</i>	<i>optic</i>	<i>switching</i>	<i>CCT</i>	<i>finish</i>	<i>code</i>
220/240V	45W	Linear LED	4300lm	pendant	dark-light	DALI	3000K	white	BZRL1614I39WBO
			4500lm				4000K	black	BZRL1614I39WNE
								white	BZRL1614I39NBO
								black	BZRL1614I39NNE

note

remote driver | RAL 9005 black | RAL 9016 white, CRI 80

included

1 x driver | 1 driver box (40x5x4,5) | 1 electrical cable length 3m | 2 x adjustable metal cable length 3m (including ceiling attachments)

 **IP20 UGR <19**

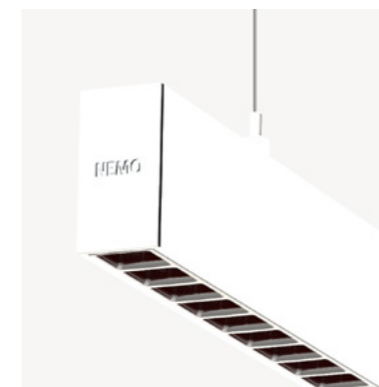

white finish



black finish



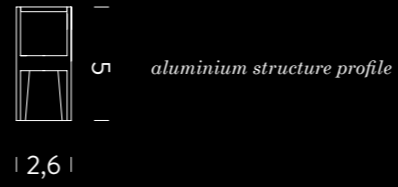

45W / 4300lm

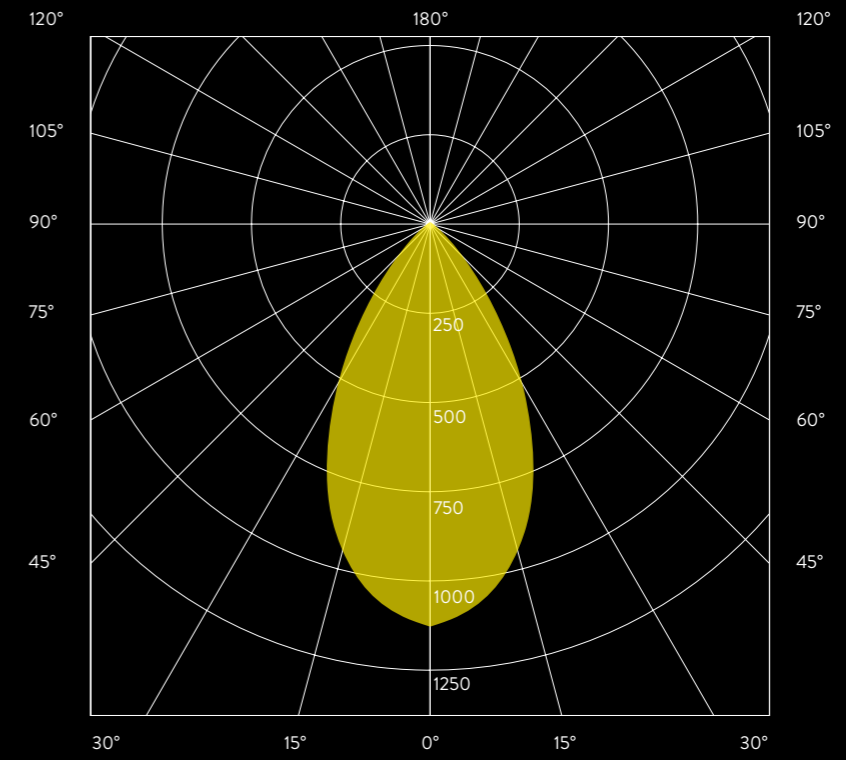

CO / C180 cd / 1000lm

GENERAL INFORMATION

Obiettivo di Nemo e Nemo Studio è quello di proporre soluzioni tecnologiche all'avanguardia, anche tramite un continuo e costante processo di aggiornamento. Per definizione la tecnologia è mutevole ed in costante evoluzione. Sugeriamo, per assicurare la consultazione delle informazioni più recenti sui prodotti, di verificare quelle disponibili sul nostro sito www.nemolighting.com. Questo documento è stato redatto a Ottobre 2021. Sostituisce ed aggiorna qualsiasi altra pubblicazione in relazione ai prodotti elencati.

Nemo and Nemo Studio's goal is to propose cutting-edge technological solutions, also through a constant updating process. By definition, technology is changing and continuously evolving. To ensure the consultation of the latest product data, we recommend referring to the information available on our website www.nemolighting.com. This document was drafted in October 2021. It replaces and updates any other publication in relation to the listed products.

Das Ziel von Nemo und Nemo Studio ist die Entwicklung von technologischen Lösungen auf dem neuesten Stand, auch durch einen ständigen Aktualisierungsprozess. Die Technik entwickelt sich ständig weiter. Um die aktuellsten Produktunterlagen einzusehen, empfehlen wir, sich auf die Informationen auf unserer Website www.nemolighting.com zu beziehen. Dieses Dokument wurde im Oktober 2021 verfasst. Es ersetzt und aktualisiert alle anderen Veröffentlichungen in Bezug auf die aufgeführten Produkte.

L'objectif de Nemo et Nemo Studio est de proposer des solutions technologiques de pointe, également à travers un processus de mise à jour constante. Par définition, la technologie évolue et change continuellement. Ce document a été rédigé en Octobre 2021. Pour garantir la consultation des dernières données produits, nous vous recommandons de vous référer aux informations disponibles sur notre site www.nemolighting.com. Remplace et met à jour toute autre publication en relation avec les produits listés.

This document supersedes and updates all previous catalogues and publications in relation to the products listed here in.

Questa pubblicazione sostituisce ed aggiorna i precedenti cataloghi con riferimento ai prodotti elencati.



The updated list of UL and ETL marked products and relevant technical information are available on the website: nemolighting.com/usa/

NEMO | NEMO_{STUDIO}

NEMO HEAD OFFICE

Viale Brianza, 30,
20823 Lentate s/S - ITALY
Tel +39 0362 166 050 0
info@nemolighting.com

NEMO STUDIO

Strada Borgata Paradiso, 20
10036 Settimo Torinese - ITALY
Tel. +39 011 765 73 01
nemostudio@nemolighting.com

SHOWROOM MILANO

Corso Monforte 19/A,
20122 Milan
Tel +39 02 970 703 40
monforte@nemolighting.com

NEMO GALLERY MILANO

Via Borgonuovo 19,
20121 Milan
studio@nemolighting.com

NEMO FRANCE | NEMO GALERIE PARIS

44, Rue du Bac
75007 Paris
Tel +33 (0) 1 40 20 47 69
Tel +33 (0) 1 486 300 77
ruedubac@nemolighting.fr
france@nemolighting.fr
nemolighting.com/fra/

NEMO USA

625 Jersey Avenue, Unit 7
New Brunswick, NJ 08901
Tel 800 734 5858
usa@nemolighting.com
nemolighting.com/usa/

PHOTOS

Marcello Perego

LOCATION

Private Residence, Milan (Italy)

Showroom Nemo Studio, via Borgonuovo 19, Milan (Italy)

EDITION

October 2021

PRINTED BY

L'artigrafica SRL

Scan the code for Terms and Conditions



For more info visit our website

